

Catalogue

Distribution product

Wenzhou Xucky Electric Co.,Ltd

www.xucky.com



Indication Lamp & Pushbutton Switch
Warning Light & Siren

Indication Lamp



Type	Voltage	Colour	Diagram
AD22-22D	AC/DC 6V AC/DC 12V AC/DC 24V AC/DC 48V AC/DC 110V AC/DC 220V AC 110V AC 220V AC 380V	Red Pure green Yellow Pure blue Pure white	
AD22-22E	AC/DC 6V AC/DC 12V AC/DC 24V AC/DC 48V AC/DC 110V AC/DC 220V AC 110V AC 220V AC 380V	Red Pure green Yellow Pure blue Pure white	
AD22-22BS	AC/DC 6V AC/DC 12V AC/DC 24V AC/DC 48V AC/DC 110V AC/DC 220V AC 110V AC 220V AC 380V	Red Pure green Yellow Pure blue Pure white	
AD22-22CS	AC/DC 6V AC/DC 12V AC/DC 24V AC/DC 48V AC/DC 110V AC/DC 220V AC 110V AC 220V AC 380V	Red Pure green Yellow Pure blue Pure white	
AD22-22DS	AC/DC 6V AC/DC 12V AC/DC 24V AC/DC 48V AC/DC 110V AC/DC 220V AC 110V AC 220V AC 380V	Red Pure green Yellow Pure blue Pure white	

Indication Lamp



Type	Voltage	Colour	Diagram	
AD22-22ES	AC/DC 6V AC/DC 12V AC/DC 24V AC/DC 48V AC/DC 110V AC/DC 220V AC 110V AC 220V AC 380V	Red Pure green Yellow Pure blue Pure white		
AD22-22M/R	AC/DC 24V AC/DC 48V AC/DC 110V AC 200V	Red (Flash)		
AD22-22M/K	AC/DC 24V AC/DC 48V AC/DC 110V AC 220V	Black	The buzzer's voice interrupted flash light volume is 10cm/80Decibel, electric current is 15~20mA	
AD22-22 Double-color	AC/DC 24V AC/DC 48V AC/DC 110V AC 220V	Red-Green Red-Yellow Red-Blue		
AD22-30DS Dia=30mm	AC/DC 6V AC/DC 12V AC/DC 24V AC/DC 48V AC/DC 110V AC/DC 220V	Red Pure green Yellow Pure blue Pure white		
Type	Voltage	Colour	Shape drawing	Diagram
BA7S	AC/DC 6V AC/DC 12V AC/DC 24V	Red Green Yellow White Blue		

LED Bulb



Type	Voltage	Colour	Shape drawing	Diagram
High brightness pure colour $\varnothing 7$	AC/DC 6V AC/DC 12V AC/DC 24V	Red Green Yellow White Blue		
High brightness pure colour $\varnothing 7$	AC/DC 6V AC/DC 12V AC/DC 24V	Red Green Yellow White Blue		
B9AS/S	AC/DC 6V AC/DC 12V AC/DC 24V	Red Green Yellow White Blue		
B9AS	AC/DC 6V AC/DC 12V AC/DC 24V AC/DC 110V AC/DC 220V	Red Green Yellow White Blue		
E10	AC/DC 6V AC/DC 12V AC/DC 24V AC/DC 110V AC/DC 220V	Red Green Yellow White Blue		

Indicator

Signal units ø22 Ip40



XB2-EV164



XB2-EV444

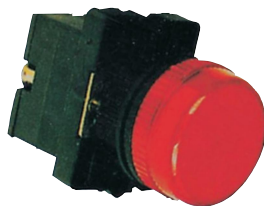

XB2-EV64

Description	Scheme	Supply voltage	Color	Reference
Direct supply (1)				
For using with incandescent bulb (included) BA 9s base fitting		130V 50/60Hz	Green	XB2-EV133
			Red	XB2-EV134
			Yellow	XB2-EV135
			Blue	XB2-EV136
			White	XB2-EV161
For using with incandescent bulb (included) BA 9s base fitting		≤250V 50/60Hz	Green	XB2-EV163
			Red	XB2-EV164
			Yellow	XB2-EV165
			Blue	XB2-EV166
			Clear	XB2-EV167
For using with incandescent bulb (included) E10/13 base fitting		≤250V 50/60Hz	White	XB2-EV661
			Green	XB2-EV663
			Red	XB2-EV664
			Yellow	XB2-EV665
			Blue	XB2-EV666
			Clear	XB2-EV667

(1) Bulb types for using with direct supply: incandescent bulb $U \leq 250V$, max.power 3W, max.diameter length 28 mm.

For using with neon bulb (included) BA 9s base fitting		240V~50/60Hz 220/240V bulb 400V~50/60Hz 380/415V bulb	Green	XB2-EV443
			Red	XB2-EV444
			Yellow	XB2-EV445
			Blue	XB2-EV446
			Clear	XB2-EV447
		230V~50/60Hz 130V bulb	Green	XB2-EV453
			Red	XB2-EV454
			Yellow	XB2-EV455
			Blue	XB2-EV456
			Clear	XB2-EV457

Supply direct through resistor

For using with incandescent bulb (included) BA 9s base fitting			White	XB2-EV171
			Green	XB2-EV173
			Red	XB2-EV174
			Yellow	XB2-EV175
			Blue	XB2-EV176
			Clear	XB2-EV177
BA 9s 6.3V/24V bulb supplied	Via integral transformer 1.2VA	220V~240V/6.3V 50/60Hz	Green	XB2-EV1853
			Red	XB2-EV1854
			Yellow	XB2-EV1855
			Blue	XB2-EV1856
BA 9s 6.3V/24V bulb supplied	Via integral transformer 1.2VA	220V~240V/6.3V 50/60Hz	Green	XB2-EV1873
			Red	XB2-EV1874
			Yellow	XB2-EV1875
			Blue	XB2-EV1876
Direct BA 9s		≤380V	White	XB2-EV61
			Green	XB2-EV63
			Red	XB2-EV64
			Yellow	XB2-EV65
			Blue	XB2-EV66
BA 9s, 130V Direct through resistor BA 9s, 130V bulb supplied		220V 250V	White	XB2-EV71
			Green	XB2-EV73
			Red	XB2-EV74
			Yellow	XB2-EV75
			Blue	XB2-EV76

Indicator

Circular head

Complete units with screw and captive cable clamp connections

Pushbuttons, spring return						
Description	Contact Type	Scheme	Color	Reference		
Pushbutton spring return	N/O		Black	XB2-EA121		
			Green	XB2-EA131		
	N/C		Red	XB2-EA142		
			N/C+N/O		Black	XB2-EA125
					Green	XB2-EA135
	Red	XB2-EA145				
Pushbutton latching	N/C		Black	XB2-EH121		
			Green	XB2-EH131		
	N/C+N/O		Black	XB2-EH125		
			Green	XB2-EH135		
Flush	N/O		Black	XB2-EA21		
			Green	XB2-EA31		
			Yellow	XB2-EA51		
			Blue	XB2-EA61		
	N/C		Red	XB2-EA42		
Mushroom head ø40mm	N/O		Black	XB2-EC21		
			Green	XB2-EC31		
			Yellow	XB2-EC51		
			Blue	XB2-EC61		
	N/C		Red	XB2-EC42		
Mushroom head	N/C		ø30	XB2-ES442		
			ø40	XB2-ES542		
			ø60	XB2-ES642		
Flush	N/O		Green	XB2-EA3311		
			White ↑ or →	XB2-EA3341		
			Black ↓ or →	XB2-EA3351		
	N/C		Red O	XB2-EA4322		
			Red stop	XB2-EA4342		



XB2-EA142



XB2-EA135



XB2-EA42

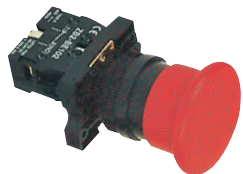

XB2-EC42



XB2-ES542



XB2-EA3341



XB2-EA4322

Pushbutton Switch

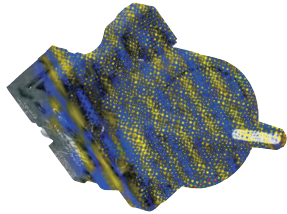

XB2-ED21

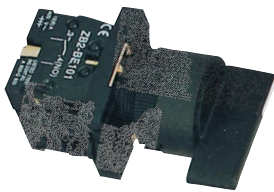

XB2-EJ33



XB2-EG33



ZB2-BE102



ZB2-BE101



ZB2-BE102



ZB2-BE101



ZB2-BZ102



ZB2-BZ101

Selector switches

Description	Contact/Type	Scheme	Operator	Reference
2 Position stay put	N/O		Standard handle	XB2-ED21
			Long handle	XB2-EJ21
	N/O+N/C		Standard handle	XB2-ED25
			Long handle	XB2-EJ25
2 Position 1 spring return from right to left	N/O		Standard handle	XB2-ED41
			Long handle	XB2-EJ41
	N/O+N/C		Standard handle	XB2-ED45
			Long handle	XB2-EJ45
3 Position stay put	N/O+N/O		Standard handle	XB2-ED33
			Long handle	XB2-EJ33
3 Position 2 spring return to centre	N/O+N/O		Standard handle	XB2-ED53
			Long handle	XB2-EJ53

Key switches(key n° 455)

Description	Contact/Type	Scheme	Key removal	Reference	
2 Position stay put	N/O		LH position	XB2-EG21	
			LH and RH position	XB2-EG41	
	N/C+N/O		LH position	XB2-EG25	
			LH and RH position	XB2-EG45	
2 Position 1 spring return from right to left	N/O		LH position	XB2-EG61	
			N/O+N/O		LH position
	3 Position stay put	N/O+N/O		Centre position	XB2-EG33
				LH and RH position	XB2-EG53
All 3 position				XB2-EG03	
3 Position 2 spring return to centre position	N/O+N/O		Centre position	XB2-EG73	

Additional/replacement contact block, screw and captive cable

For making up body assemblies with 3,4, 5 or maximum of 6 contact blocks or replacing 1st or and contact	N/O	Clamp connection		ZB2-BE101
	N/C			ZB2-BE102
	N/O			ZB2-BZ101
	N/C			ZB2-BZ102
	N/O+N/O			ZB2-BZ103
	N/C+N/C			ZB2-BZ104
	N/O+N/C			ZB2-BZ105

Pushbutton Switch

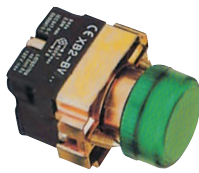

XB2-BV63

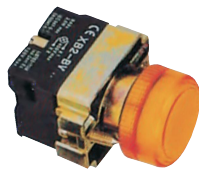

XB2-BV65

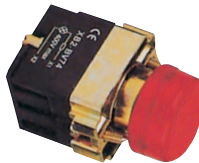

XB2-BV74

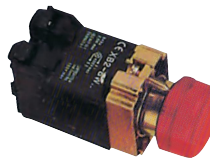

XB2-BV44

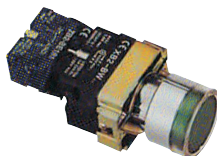

XB2-BW3361

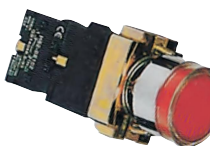

XB2-BW3471

Circular head, screw and captive cable clamp connections Complete units

Signal units ø22				
Description	Scheme	Supply/voltage	Color	Reference
Direct bulb included		≤ 380V	Green	XB2-BV63
			Red	XB2-BV64
			Yellow	XB2-BV65
Via integral resistor BA 9s, 130V bulb supplied		220V 250V	Green	XB2-BV73
			Red	XB2-BV74
			Yellow	XB2-BV75
Via integral transformer 1.2VA BA 9s, 6V bulb supplied		110V/50Hz 110-120V/60Hz	Green	XB2-BV33
			Red	XB2-BV34
			Yellow	XB2-BV35
		220V/50Hz	Green	XB2-BV43
			Red	XB2-BV44
			Yellow	XB2-BV45
		240V/50Hz	Green	XB2-BV943
			Red	XB2-BV944
			Yellow	XB2-BV945
		380V/50Hz	Green	XB2-BV53
			Red	XB2-BV54
			Yellow	XB2-BV55
		415V/50Hz	Green	XB2-BV933
			Red	XB2-BV934
			Yellow	XB2-BV935

Illuminated flush pushbuttons with 1N/O contact











Supply	Scheme	Supply/voltage	Color	Reference
Direct bulb supplied		≤ 380V	Green	XB2-BW3361
			Red	XB2-BW3461
			Yellow	XB2-BW3561
Direct through resistor BA 9s, 130V bulb supplied		220V 250V	Green	XB2-BW3371
			Red	XB2-BW3471
			Yellow	XB2-BW3571
Via integral transformer 12.VA BA 9s, 6V bulb supplied		110V/50Hz 110-120V/60Hz	Green	XB2-BW3331
			Red	XB2-BW3431
			Yellow	XB2-BW3531
		220V/50Hz	Green	XB2-BW3341
			Red	XB2-BW3441
			Yellow	XB2-BW3541
		240V/50Hz	Green	XB2-BW33941
			Red	XB2-BW34941
			Yellow	XB2-BW35941
		380V/50Hz	Green	XB2-BW3351
			Red	XB2-BW3451
			Yellow	XB2-BW3551
		415V/50Hz	Green	XB2-BW33931
			Red	XB2-BW34931
			Yellow	XB2-BW35931

Pushbutton Switch

Circular head, with chromium plated metal bezel

Complete units with screw and captive cable clamp connections

Pushbuttons, spring return

Description	Contact/type	Scheme	Color	Reference
Flush	N/O		Black	XB2-BA21
			Green	XB2-BA31
			Yellow	XB2-BA51
			Blue	XB2-BA61
	N/C		Red	XB2-BA42
Projecting	N/O		Black	XB2-BL21
			Green	XB2-BL31
			Yellow	XB2-BL51
			Blue	XB2-BL61
	N/C		Red	XB2-BL42
Booted	N/O		Black	XB2-BP21
			Green	XB2-BP31
			Yellow	XB2-BP51
			Blue	XB2-BP61
	N/C		Red	XB2-BP42
Mushroom head 40mm	N/O		Black	XB2-BC21
			Green	XB2-BC31
			Yellow	XB2-BC51
			Blue	XB2-BC61
	N/C		Red	XB2-BC42
Mushroom head 60mm	N/O		Black	XB2-BR21
			Green	XB2-BR31
			Yellow	XB2-BR51
			Blue	XB2-BR61
	N/C		Red	XB2-BR42

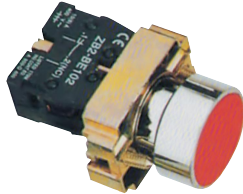

XB2-BA42

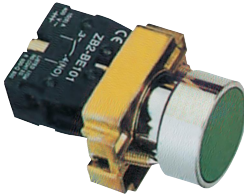

XB2-BA31

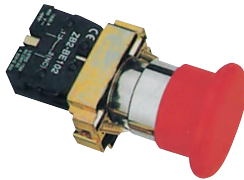

XB2-BC42

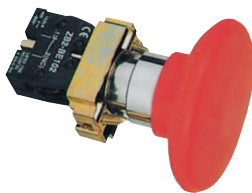

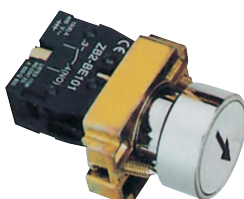

XB2-BR42



XB2-BA3341

Pushbuttons, spring return

Description	Contact/type	Scheme	Color	Reference
Flush	N/O		Green	XB2-BA3311
			White ↑ or →	XB2-BA3341
			Black ↓ or ⇐	XB2-BA3351
	N/C		Red o	XB2-BA4222
			Red stop	XB2-BA4342
Projecting	N/C		Red o	XB2-BA4322
			Red stop	XB2-BA4342

Pushbutton Switch

Circular head, with chromium plated metal bezel

Complete units with screw and captive cable clamp connections

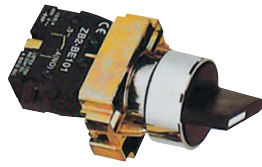

XB2-BD21

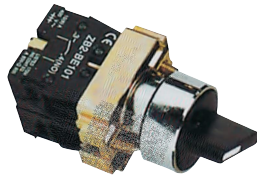

XB2-BD33

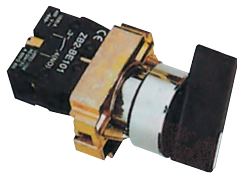

XB2-BJ21

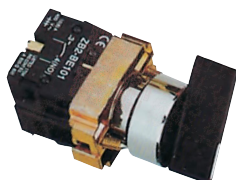

XB2-BJ33



XB2-BG21

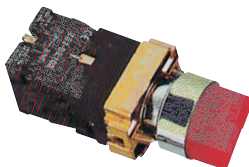

XB2-BK2465

Selector switches

Description	Contact/type	Scheme	Operator	Reference
2 Position stay put	N/O		Standard handle	XB2-BD21
	N/C+N/O		Long handle	XB2-BJ21
2 Position 1 spring return from right to left	N/O		Standard handle	XB2-BD41
	N/C+N/O		Long handle	XB2-BJ41
3 Position stay put	N/O+N/O		Standard handle	XB2-BD33
	N/O+N/O		Long handle	XB2-BJ33
3 Position 2 spring return to centre	N/O+N/O		Standard handle	XB2-BD53
	N/O+N/O		Long handle	XB2-BJ53

Key switches(key n° 445)

Description	Contact/type	Scheme	Key removal	Reference
2 Position stay put	N/O		LH Position	XB2-BG21
	N/C+N/O		LH and RH Position	XB2-BG41
2 Position 1 spring return from right to left	N/O		LH Position	XB2-BG61
	N/C+N/O		LH Position	XB2-BG65
3 Position stay put	N/O+N/O		Centre Position	XB2-BG33
	N/O+N/O		LH and RH Position	XB2-BG53
	N/O+N/O		All 3 Position	XB2-BG03

Selector switches

Description	Contact/type	Scheme	Reference
2 Position stay put	N/C+N/O		XB2-BK2365
			XB2-BK2465
			XB2-BK2565
			XB2-BK2665
			XB2-BK2765
2 Position stay put	N/C+N/O		XB2-BK3365
			XB2-BK3465
			XB2-BK3565
			XB2-BK3665
			XB2-BK3765
			XB2-BK5365
2 Position stay put	N/C+N/O		XB2-BK5465
			XB2-BK5565
			XB2-BK5665
			XB2-BK5765

Pushbutton Switch

With chromium plated metal bezel

Complete units with screw and captive cable clamp connections

Double-headed pushbuttons, spring return					
Description	Contact/type	Scheme	Scheme	Degree. of protection	Reference
Without pilot light 1 flush green pushbutton 1 projecting red pushbutton	N/O + N/C		Unmarked	IP40	XB2-BL8325
				IP65	XB2-BL9325
				IP40	XB2-BL8425
				IP65	XB2-BL9425
With pilot light 1 flush green pushbutton 1 pilot light with yellow lens Direct supply ^o 380V 1 projecting red pushbutton	N/O + N/C		Unmarked	IP40	XB2-BW8365
				IP40	XB2-BW8465
1 flush green pushbutton 1 pilot light with yellow lens 220/250V supply direct through resistor BA 9s, 130V bulb included 1 projecting red pushbutton	N/O + N/C		Unmarked	IP40	XB2-BW8375
				IP40	XB2-BW8475
1 flush green pushbutton 1 pilot light with yellow lens 1.2VA-220V direct supply via integral transformer BA 9s 6V, bulb included 1 projecting red pushbutton	N/O + N/C		Unmarked	IP40	XB2-BW8345
				IP40	XB2-BW8445

Latching mushroom head "emergency stop" pushbutton

Description	Contact/type	Scheme		Reference
Push-pull Red	N/C		ø40	XB2-BT42
			ø60	XB2-BX42
Turn to release Red			ø30	XB2-BS442
			ø40	XB2-BS542
			ø60	XB2-BS642
			Rey release(key n° 445) Red	ø30
ø40	XB2-BS142			
	ø60	XB2-BS242		

Latching mushroom head pushbutton with "Trigger action"

Turn to release Red release(Key n° 445) Red	N/O + N/C		ø40	XB2-BS8445
				XB2-BS9445

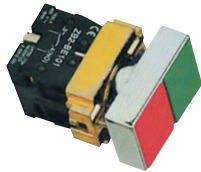

XB2-BL8325

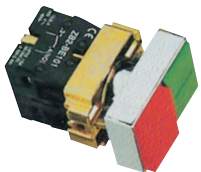

XB2-BL8425

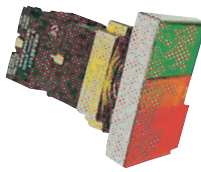

XB2-BW8465

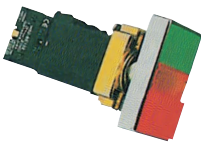

XB2-BW8445

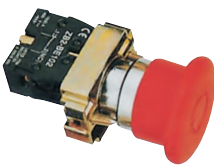

XB2-BT42

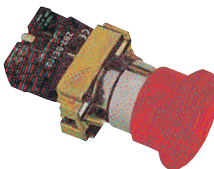

XB2-BS542



XB2-BS142

Pushbutton Switch



Type	Contact type	Colour	Voltage	Slack
XB4-BA21 XB4-BA31 XB4-BA42 XB4-BA51 XB4-BA61 XB4-BA25 XB4-BA35 XB4-BA45	NO NO NC NO NO NO+NC NO+NC NO+NC	B G R Y BL B G R		Flush
XB4-BC21 XB4-BC31 XB4-BC42 XB4-BC51 XB4-BR21 XB4-BR31 XB4-BR42 XB4-BR51	NO NO NC NO NO NO NC NO	B G R Y BL B G R		Spring return BC type ø40 BR type ø60
XB4-BS442 XB4-BS542 XB4-BS642	NC NC NC	R		Turn to release ø30 ø40 ø60
XB4-BD21 XB4-BD25 XB4-BD33 XB4-BD41 XB4-BD45 XB4-BD53	NO NO+NC NO+NO NO NO+NC NO+NO			2-position locked 2-position locked 3-position locked 2-position reset 2-position reset 3-position reset
XB4-BJ21 XB4-BJ25 XB4-BJ33 XB4-BJ41 XB4-BJ45 XB4-BJ53	NO NO+NC NO+NO NO NO+NC NO+NO			2-position locked 2-position locked 3- position locked 2-position reset 2-position reset 3-position reset

Pushbutton Switch



Type	Contact type	Colour	Voltage	Slack
XB4-BG21 XB4-BG25 XB4-BG33 XB4-BG41 XB4-BG61 XB4-BG53	NO NO+NC NO+NO NO+NO NO NO NO+NO			2-position locked 2-position locked 3-position locked 3-position locked 2-position reset 2-position reset 3-position reset
XB4-BT21 XB4-BT42 XB4-BT845	NO NC NO+NC	B R R		ø40
XB4-BL21 XB4-BL31 XB4-BL42 XB4-BL51 XB4-BL61	NO NO NC NO NO	B G R Y BL		Protruding button
XB4-BW3 □ B5 XB4-BW3 □ G5 XB4-BW3 □ M5	NO+NC	□ Ento-figure 3 G 4 R 5 Y 6 BL 7 T	24 ~48...120V ~230...240V	Illuminated BA9S Lamp socket LED BA9S bulb and neno lamp
XB4-BW3365 XB4-BW3465 XB4-BW3565 XB4-BW3665 XB4-BW3765	NO+NC	3 G 4 R 5 Y 6 BL 7 T	≤ 250V	Illuminated BA9S Lamp socket LED BA9S bulb and neno lamp

Pushbutton Switch



Type	Contact type	Colour	Voltage	Slack
XB4-BL8325 XB4-BL8312 XB4-BL8425 XB4-BL8412	NO+NC	R+G W+B R+G W+B		Double end button Flush+Flush "0" + "1" Projecting+Flush
XB4-BW8365 XB4-BW8465	NO+NC	R+G		Flush+Flush "0" + "1" Projecting+Flush LED lamp socket LED
XB4-BP21 XB4-BP31 XB4-BP42 XB4-BP51 XB4-BP61	NO NO NC NO NO	B G R Y BL		Degree of protection IP66
XB4-BS142	NC	R		ø40 ø60
XB4-BV63 XB4-BV64 XB4-BV65 XB4-BV66 XB4-BV67		G R Y BL T	≤250V	Lamp BA9S Lamp socket LED BA9S bulb and neno lamp

Pushbutton Switch



XB4-BVB □
XB4-BVG □
XB4-BVM □

□ Ento-
figure
3 G
4 R
5 Y
6 BL
7 T

24V
~48...120V
~230...240V

BA9S lamp
socket LED
BA9S bulb and
neno lamp



XB2-BK12 □ 3
2-position locked
XB2-BK13 □ 3
3-position locked
XB2-BK14 □ 3
2-position reset
XB2-BK15 □ 3
3-position reset

NO+NO
NO+NC

□ Ento-
figure
G
R
Y
BL
T

210V~220V

LED lamp socket
LED



XB4-BA3311
XB4-BA3341
XB4-BA3351
XB4-BA4322

NO
NO
NO
NC

G
W
B
R

I
↑ ↓
↑ ↓
O

Flush of marking
on



XB4-BH02
XB4-BH03
XB4-BH04
XB4-BH05
XB4-BH06

NO+NC

B
G
R
Y
BL

Flush of self-
locking



XB4-BL9312
XB4-BL9434

NO+NC

W+B
R+G

Flush+Projecting
Projecting+Flush
Degree of
protection IP66

Pushbutton Switch

Push button with light, Push button, Pilot light(ø8, ø12)



Circular



Square



Rectangular







































Circular



Square



Rectangular

Function	Model	Contact structure	Color			
Pilot light Self-reset Self-locking type	AY50-12AY-D	SPDT SPDT	Red Green Yellow Blue White			
	AY50-12AY-  / 					
	AY50-12AY-  T/ 					
	AY50-12AY-  D/ 					
	AY50-12AY-  TD/ 					
	AY50-12AF-D					
	AY50-12AF-  / 					
	AY50-12AF-  T/ 					
	AY50-12AF-  D/ 					
	AY50-12AF-  TD/ 					
	AY50-12AJ-D					
	AY50-12AJ-  / 					
	AY50-12AJ-  T/ 					
	AY50-12AJ-  D/ 					
	AY50-12AJ-  TD/ 					
	Pilot light Self-reset Self-locking type			AY50-8AY-D	SPDT SPDT	Red Green Yellow Blue White
				AY50-8AY-11/ 		
				AY50-8AY-11T/ 		
AY50-8AY-11D/ 						
AY50-8AY-11TD/ 						
AY50-8AF-D						
AY50-8AF-11/ 						
AY50-8AF-11T/ 						
AY50-8AF-11D/ 						
AY50-8AF-11TD/ 						
AY50-8AJ-D						
AY50-8AJ-11/ 						
AY50-8AJ-11T/ 						
AY50-8AJ-11D/ 						
AY50-8AJ-11TD/ 						

Filling in normal open and close number is front of , color in back of .

Pushbutton Switch

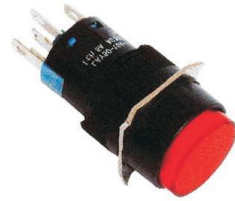

Circular

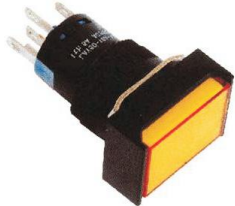

Square

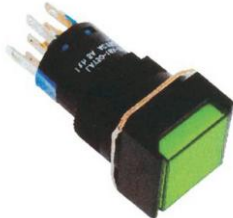

Rectangular

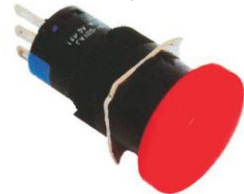

Mushroom push button

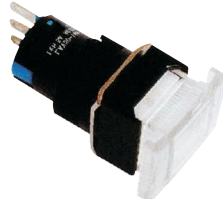

Big square

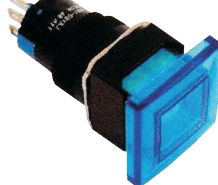



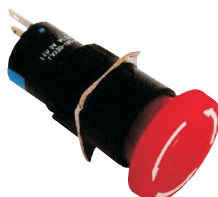



























Big rectangular



Emergency push button

Common push button, Push button with light, indicator light, Emergency push button

Function	Model	Voltage class	Color
Pilot light	AY50-16AY-D	LED AC/DC 6V 12V 24V NE 100V 220V	Red
	AY50-16AF-D		Green
	AY50-16AJ-D		Yellow
Instantaneous type	AY50-16AY-  / 		Blue
	AY50-16AF-  / 		White
	AY50-16AJ-  / 		Black
Self-locking type	AY50-16AY-  T/ 		Transparent
	AY50-16AF-  T/ 		Note:black button cover is not used with light
	AY50-16AJ-  T/ 		
Instantaneous type	AY50-16AM-  / 	LED AC/DC 6V 12V 24V NE 100V 220V	Red
	AY50-16ADF-  / 		Green
	AY50-16ADJ-  / 		Yellow
Self-locking type	AY50-16AM-  T/ 		Blue
	AY50-16ADF-  T/ 		White
	AY50-16ADJ-  T/ 		Black
Press locking reset right on the	AY50-16AM-  T/ 		Transparent
	AY50-16ADF-  T/ 		Note:black button cover is not used with light
	AY50-16ADJ-  T/ 		
Press locking reset right on the	AY50-16AY-  Z		Red
			Green

Filling in normal open and close number is front of  , color in back of  .

Pushbutton Switch

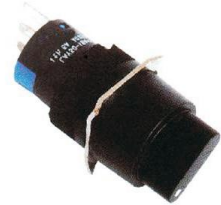

Circular

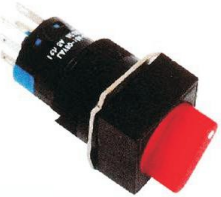

Square

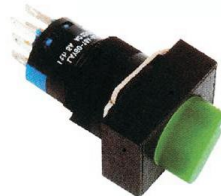

Rectangular



Circular



Square

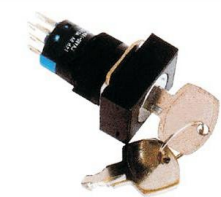

Rectangular

Turn button, Key push button, Buzzer

Working state	Model	Color
 2 Position 90° 45° 90° 3 Position 2 Position 90° 45° 90° 3 Position 2 Position 90° 45° 90° 3 Position	AY50-16AY-X/ AY50-16AF-X/ AY50-16AJ-X/ AY50-16AY-22XS/ AY50-16AF-22XS/ AY50-16AJ-22XS/	Red Green Blue

Working state	Model	Key removable position
 2 Position 90° 45° 90° 3 Position 2 Position 90° 45° 90° 3 Position 2 Position 90° 45° 90° 3 Position	AY50-16AY-Y AY50-16AF-Y AY50-16AJ-Y AY50-16AY-22YS AY50-16AF-22YS AY50-16AJ-22YS	Key two-position, which can be taken out in two positions Key three-position has two types: 1. Key is taken out in middle 2. Key is all taken out in three positions

Filling in normal open and close number is front of , color in back of .



Circular



Square

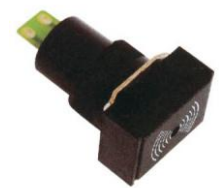

Rectangular

Indicators



YL238-03



YL238-04



YL238-05



YL238-06



YL240-01



YL240-02



YL240-03



YL240-04



YL240-05



YL240-06



COB61 COB62 COB63 COB63A COB62A COB61A



HJ9-6



HJ9-4



HJ9-3



HJ9-1

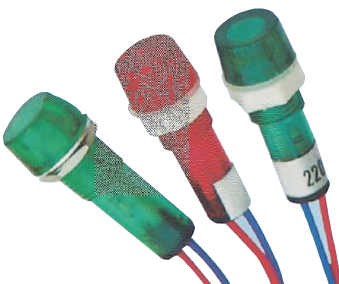

YL235



YL240



YL244-01



YL244-02



YL244-03

Motive Switch

1. External Appearance Size

BSN-310

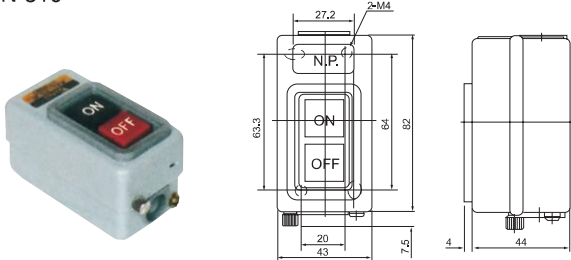

BSP-315

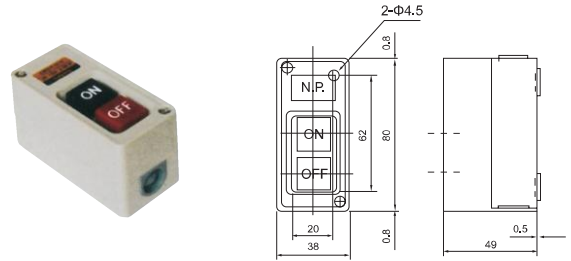

BSN-315

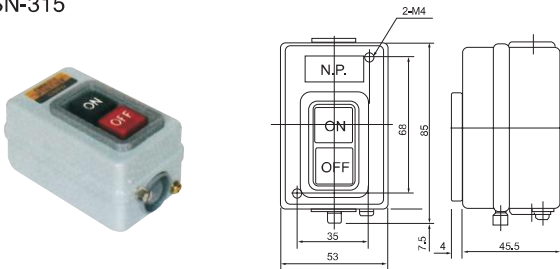

BSP-330

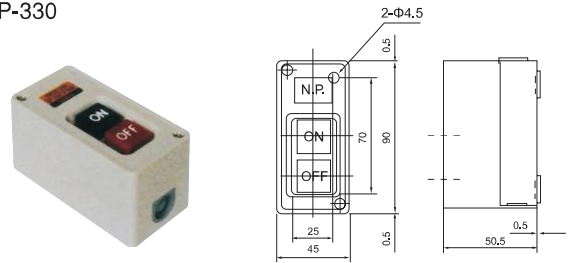

BSN-330

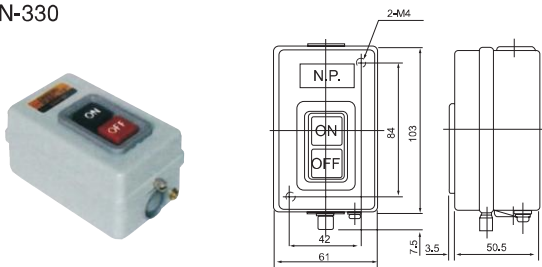

BSY-315,330

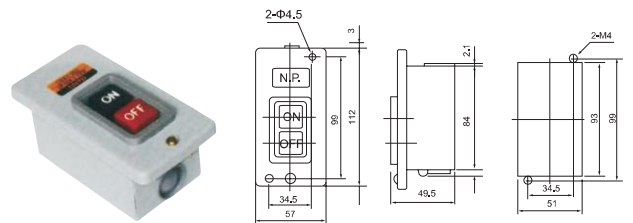

BSS-315,330

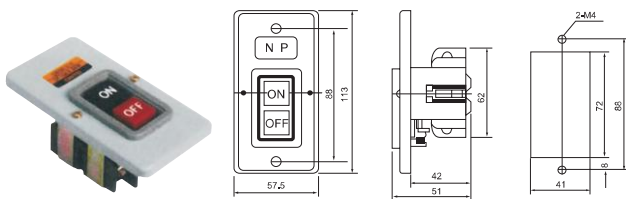

PB-2

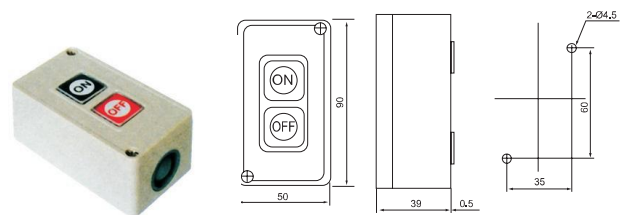

PB-3

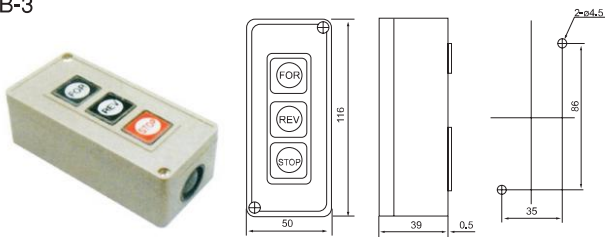

Limit Switch

1. Application

Limit switches are ideal electrical control switches in mechanical and other industries. They have features of complete specifications and varieties of types, compact structure, nice appearance, excellent performance, flexible and reliable action, easy installation, operation, maintenance and adjustment.

The switches are applicable to AC control circuits of 40 to 60Hz, with a voltage up to 500V or DC control circuits with a voltage up to 600V, and a current up to 10A to convert a mechanical signal into an electrical signal for the purpose of controlling mechanical movement or performing sequential control.

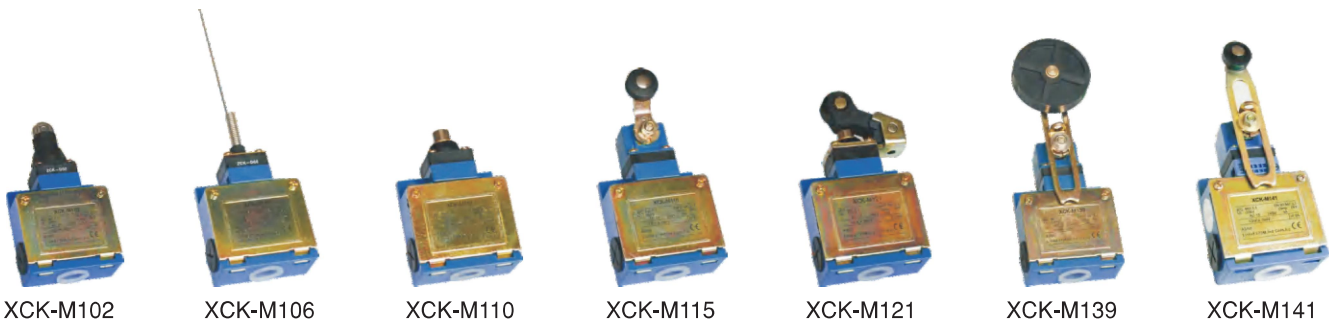

XCK-M102 XCK-M106 XCK-M110 XCK-M115 XCK-M121 XCK-M139 XCK-M141



XCK-P102 XCK-P106 XCK-P110 XCK-P118 XCK-P121 XCK-P127 XCK-P128 XCK-P139 XCK-P145 XCK-P155



XCK-T102 XCK-T106 XCK-T110 XCK-T118 XCK-T121 XCK-T127 XCK-T128 XCK-T145



XCK-T155 XCK-S101 XCK-S102 XCK-S121 XCK-S131 XCK-S141 XCK-S139

Limit Switch



XCK-J10511



XCK-J10531



XCK-J10541



XCK-J10559



XCK-J108



XCK-J121



XCK-J139



XCK-J161



XCK-J167



ME9101



ME8104



ME8107



ME8108



ME8111



ME8112



ME8122



ME8166



ME8169



MEA-9104



MEA-9107



MEA-9108



MEA-9111



MEA-9122



MEA-9124



MEA-9127



MEA-9128



MEA-9139



MEA-9161



MEA-9112



MEA-9166



MEA-9169



TZ-8104



TZ-8107



TZ-8108



TZ-8111



TZ-8112



TZ-8122



TZ-8166



TZ-8167



TZ-8169



WL-CA2



WL-CA2-2



WL-CA12



WL-CA12-2



WL-CA32-41



WL-CL



WL-D

Limit Switch



WL-D2



WL-NJ



WL-NJ-S2



HL-5000



HL-5030



HL-5050



HL-5100



HL-5200



HL-5300



3SE3 120-1B



3SE3 120-1C



3SE3 120-1D



3SE3 120-1E



3SE3 120-1G



3SE3 120-1R



3SE3 120-1T



3SE3 120-1U



3SE3 120-1W



3SE3 100-1B



3SE3 100-1D



3SE3 100-1E



3SE3 100-1F



3SE3 100-1G



3SE3 100-1R



3SE3 100-1T



3SE3 100-1U



3SE3 100-1W



LXK3-20H/B



LXK3-20H/D



LXK3-20H/H



LXK3-20H/J



LXK3-20H/L



LXK3-20S/B



LXK3-20S/D



LXK3-20S/H₂



LXK3-20S/J



LXK3-20S/L



LXK3-20S/T



LXK3-20S/W



LXK3-20S/Z

Micro Switch

1. Application

General purpose micro switches are used in AC control circuits of 50/60Hz, with a voltage up to 380V and a rated control capacity of 100VA or in DC control circuits with a voltage up to 220V and a rated control capacity of 10W.



Z-15HW24-B



Z-15GD-B



Z-15GQ-B



Z-15GQ21-B



Z-15GQ22-B



Z-15GW-B



Z-15GW2-B



Z-15GW21-B



Z-15GW22-B



Z-15G-B



LXW5-11D



LXW5-11G1



LXW5-11G2



LXW5-11G3



LXW5-11M



LXW5-11N1



LXW5-11N2



LXW5-11Q1



LXW5-11Q2



LXW5-11Z



AZ-7100



AZ-7110



AZ-7120



AZ-7121

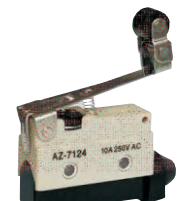

AZ-7124



AZ-7140



AZ-7141



AZ-7144

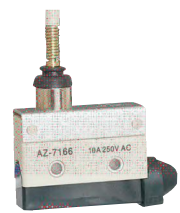

AZ-7166



AZ-7310

Micro Switch



V-15-1C25



V-151-1C25

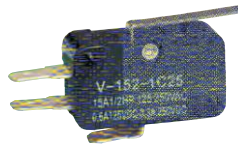

V-152-1C25



V-153-1C25



V-154-1C25



V-155-1C25



V-156-1C25



MJ1-6101



MJ1-6102



MJ1-6102R



MJ1-6104



MJ1-6107



MJ1-6111



MJ1-6112



MJ1-6114



MJ1-6117



AZ-7311



AZ-7312



D4MC-1000

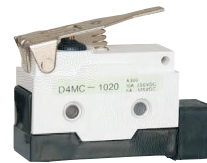

D4MC-1020

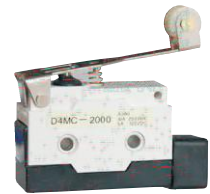

D4MC-2000



D4MC-2020



D4MC-3030



D4MC-5000



D4MC-5020



D4MC-5040

Toggle Switch



ON-OFF 1021



ON-OFF-ON 1122



ON-ON 1121



ON-OFF 1401



ON-ON 1402



ON-OFF-ON 1403

Foot Switch

FS-201 202

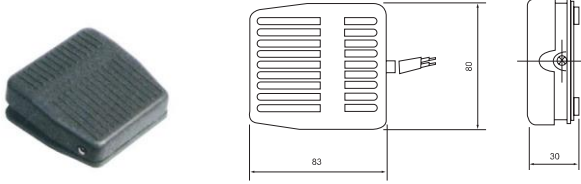

FS-01

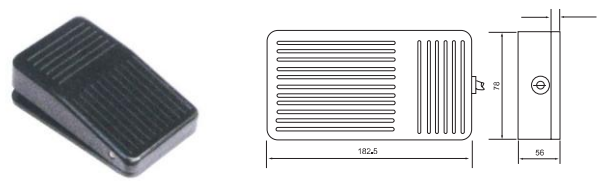

FS-101 102 105

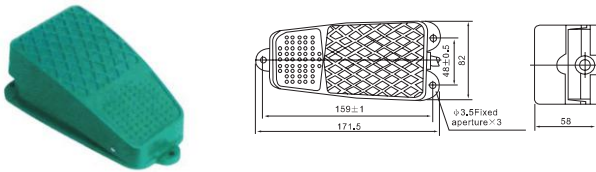

FS-1

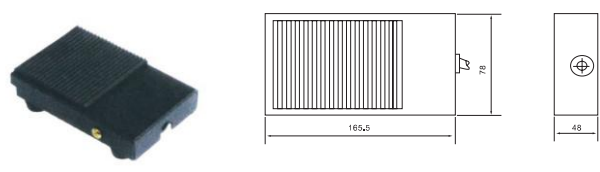

FS-2

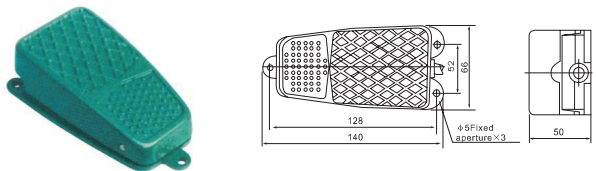

FS-3 3S

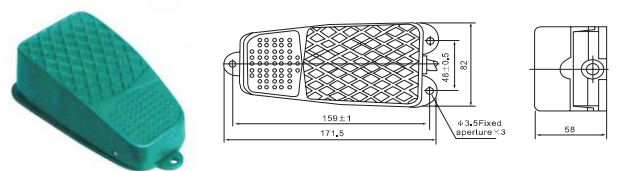

FS-302

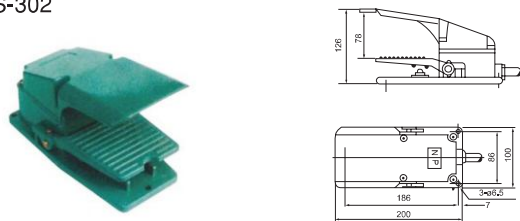

FS-402

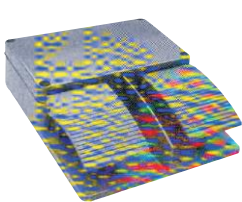
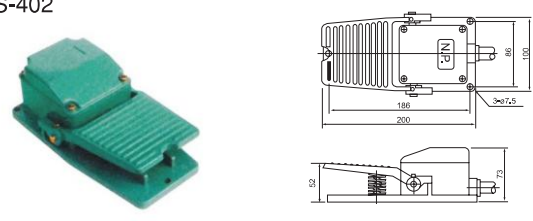

SFMS-10

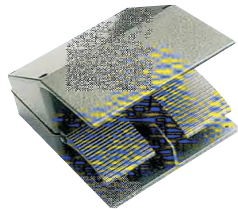

SFMS-15

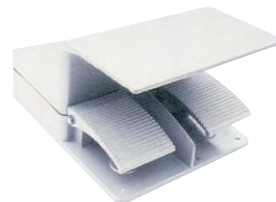

SFMS-20



MD13HS

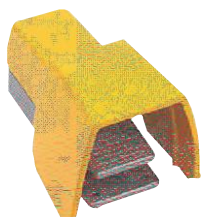

MD-88H



MD-68H



YDT1-101



8013

LW26 Series Rotary Switches



LW26-20



LW26-32

1. Working Conditions

Ambient temperature Do Not exceed 40°C and the average temperature, measured over a period of 24 hours, Do Not exceed 35°C.

Ambient temperature should not be below -5°C.

Should not be installed over 2000m above sea level.

The humidity should not exceed 50% when the ambient temperature is 40°C and higher humidity is allowed for lower temperature.

2. Installation Conditions

A clean environment is required.

Please follow our manual.

3. Escutcheon Plate and Handle

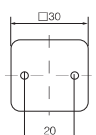
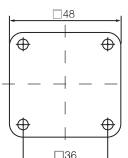
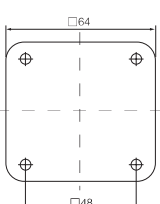
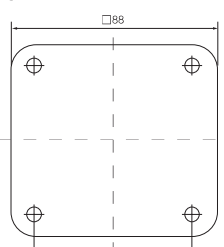
Escutcheon plate	Type of handle	Color	Escutcheon plate				Type of handle	Color	Escutcheon plate																								
			M0	M1	M2	M3			M0	M1	M2	M3																					
M0 	R Type	Black Red White Gray	●	●	●							I Type	Black Red White Gray Yellow	●	●	●																	
	M1 	F Type	Black Red White Gray	●	●																	B Type	Black Red White Gray		●	●							
M2 		H Type	Black Red White Gray			●																L Type	Black Red White Gray				●						
	M3 	P Type	Black Red White Gray			●	●															K Type	Black Red White Gray				●	●					

LW26 Series Rotary Switches

4. Outline and Installation Dimension (mm)

Dimensions and installation

Square escutcheon plate and rectangular escutcheon plate



LW26-20

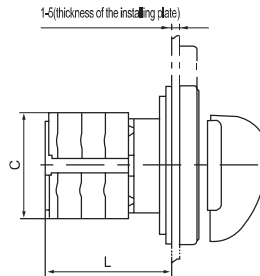
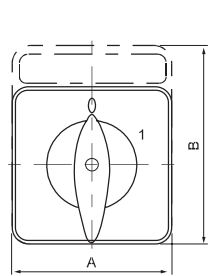

LW26-10
Installation

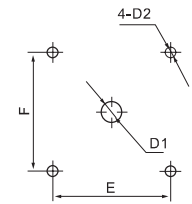

LW26-160
Installation



LW26-32

Description	Escutcheon plate	Dimension(mm)				Installation(mm)			
		A	B	C	L	E	F	D1	D2
LW26-10	M0 square	30	30	28	22+8n	20		ø8	ø3.2
LW26X-10	M0 square	30	30	28	26.5+12n	20		ø8	ø3.2
LW26-20	M1 square	48	48	43	22+9.6n	36	36	ø8.5	ø4.5
	M1 rectangular	48	60	43	22+9.6n	36	36	ø8.5	ø4.5
	M2 square	64	64	43	25+9.6n	48	48	ø10	ø4.5
	M2 rectangular	64	80	43	25+9.6n	48	48	ø10	ø4.5
LW26X-20	M1 square	48	48	46	22+14n	36	36	ø8.5	ø4.5
	M1 rectangular	48	60	46	22+14n	36	36	ø8.5	ø4.5
	M2 square	64	64	46	25+14n	48	48	ø10	ø4.5
	M2 rectangular	64	80	46	25+14n	48	48	ø10	ø4.5
LW26-25	M1 square	48	48	45.2	23+12.8n	36	36	ø8.5	ø4.5
	M1 rectangular	48	60	45.2	23+12.8n	36	36	ø8.5	ø4.5
	M2 square	64	64	45.2	26.5+12.8n	48	48	ø10	ø4.5
	M2 rectangular	64	80	45.2	26.5+12.8n	48	48	ø10	ø4.5
LW26-32	M2 square	64	64	58	29.2+12.8n	48	48	ø10	ø4.5
	M2 rectangular	64	80	58	29.2+12.8n	48	48	ø10	ø4.5
LW26-32F	M1 square	48	48	48	23+14n	36	36	ø8.5	ø4.5
	M1 rectangular	48	60	48	23+14n	36	36	ø8.5	ø4.5
	M2 square	64	64	48	24.5+14n	48	48	ø10	ø4.5
	M2 rectangular	64	80	48	24.5+14n	48	48	ø10	ø4.5
LW26-63	M2 square	64	64	66	29.2+21.5n	48	48	ø10	ø4.5
	M2 rectangular	64	80	66	29.2+21.5n	48	48	ø10	ø4.5
	M3 square	88	88	66	29.2+21.5n	68	68	ø13	ø4.5
	M3 rectangular	88	107	66	29.2+21.5n	68	68	ø13	ø4.5
LW26-125	M3 square	88	88	84	35+26.5n	68	68	ø13	ø6
	M3 rectangular	88	107	84	35+26.5n	68	68	ø13	ø6
LW26-160	M3 square	88	88	88	35+26.5n	68	68	ø13	ø6
	M3 rectangular	88	107	88	35+26.5n	68	68	ø13	ø6

LW26GS Series Park-lock Type Switches

1. Classification



LW26GS-20/04-1

(1) The LW26GS switch has 6 current ratings: 20A, 25A, 32A, 63A, 125A and 160A. For 20A and 25A is able to install M1 or M2 plate, and for 32A and 63A is able to install M2 or M3 plate, for 125A and 160A is able to install M3 plate only. The M1 plate is able to put 2 Re: -1, -2, -3 represent M1, M2, M3.

(2) The LW 26GS switch has two types:

Common type, black plate black handle

Quick stop type, with quick stop mark, yellow plate and red handle.



LW26GS-20/24-2

2. Technical Parameters

Description		LWGS26-20	LWGS26-25	LWGS26-32	LWGS26-63	LWGS26-125	LWGS26-160
Rated working voltage(Ue)	V	440	440	440	440	440	440
Rated thermal current(Ith)	A	20	25	32	63	125	160
Rated working current(Ie)							
AC-21A	A	20	25	32	63	100	150
AC-22A	A	20	25	32	63	100	150
AC-23A	A	15	22	30	57	90	135
Power(P)							
AC-23A	kW	7.5	11	15	30	45	75
Operation							
Non-load		8500	8500	8500	8500	8500	8500
Load		1500	1500	1500	1500	1500	1500
Total		10000	10000	10000	10000	10000	10000



LW26GS-63/04-2

3. Outline and Installation Dimension (mm)



LW26GS-63/04-3

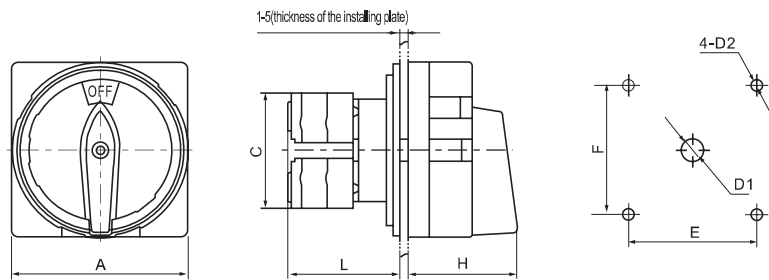

LW26GS-125/04-3

Description	Escutcheon plate	Dimension(mm)				Installation(mm)			
		A	C	L	H	E	F	D1	D2
LW26GS-20	M1	48	43	42	33	36	36	ø8.5	ø4.5
LW26GS-20	M2	64	43	43	42	48	48	ø8.5	ø4.5
LW26GS-25	M1	48	45.2	50	33	36	36	ø8.5	ø4.5
LW26GS-25	M2	64	45.2	51	42	48	48	ø8.5	ø4.5
LW26GS-32	M2	64	58	55	42	48	48	ø10	ø4.5
LW26GS-32	M3	88	58	55	52	68	68	ø13	ø6
LW26GS-63	M2	64	66	72.5	42	48	48	ø10	ø4.5
LW26GS-63	M3	88	66	72.5	52	68	68	ø13	ø6
LW26GS-125	M3	88	84	88	52	68	68	ø13	ø6
LW26GS-160	M3	88	88	100	52	68	68	ø13	ø6

LW30 Series Rotary Switches

1. Designation

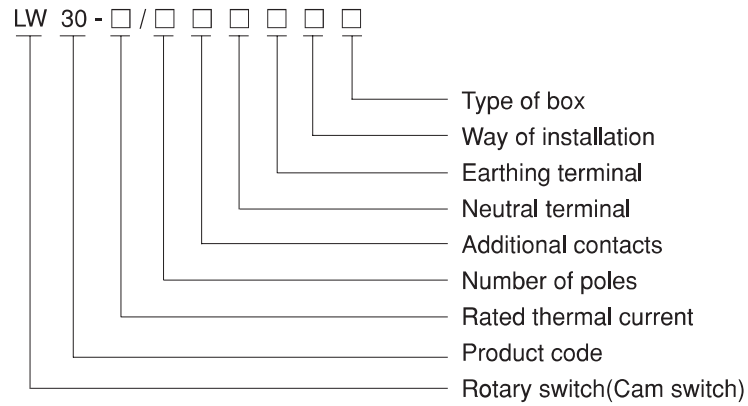

LW30-20, 32

2. Working Conditions

Ambient temperature Do Not exceed 40°C and the average temperature, measured over a period of 24 hours, Do Not exceed 35°C.

Ambient temperature should not be below -5°C.

Should not be installed above 2000m above sea level.

The humidity should not exceed 50% when the ambient temperature is 40°C and higher humidity is allowed for lower temperature.

Current type: 50Hz AC

Number of main contact: ON and OFF

Frequency: 8 hours per day, 30 times per hour

Mechanism Life: 10000 times/AC-23, 6000 times/AC-3, 2000 times for additional contact.



LW30-80, 100

3. Accessorial Code

Number of poles: 3P, 4P

Additional contacts: 0 for additional contacts not inclosed, 1 for with additional contacts

Neutral terminal: 0 for neutral terminal not inclosed, 1 for with earthing terminal.

Installation:

- Pad-lock escutcheon plate
- Escutcheon plate
- Single lock parallel installation
- Doorlock safety switch with padlock system
- Single hole installation

Type of box: 0 without protective box, 1 with IP65 plastic box

4. Installation Conditions

- A clean environment is required.
- Please follow our manual.

Float Switch

1. Application

Note1(Outline code): "1"-Trapezium "2"-Rectangle "3"-Large circular
 "4"-Small circular "5"-

Note2(Colour code): "R"-Red "Y"-Yellow "S"-Blue "G"-Gray "B"-Black

Note3(Weight code): "1"-Plasticsloop-tightened type(usually no marked)
 "2"-Plastics clamp plate screw tightened type(marked must)

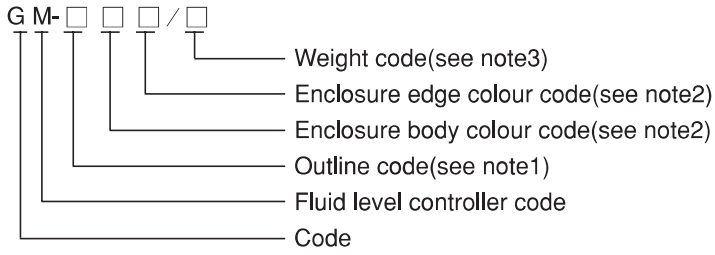
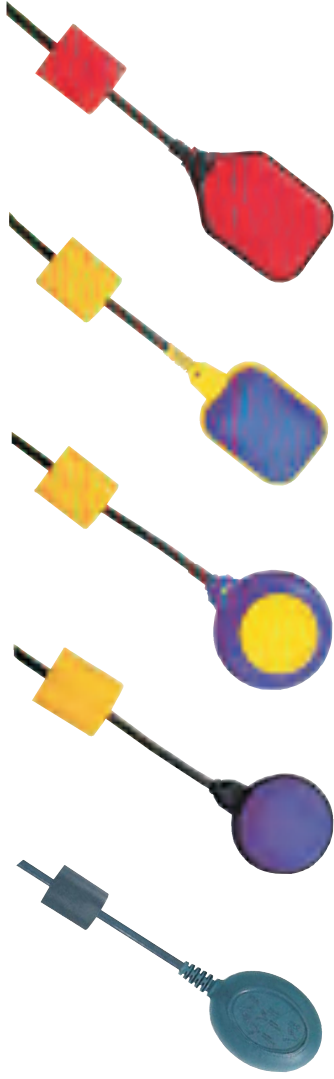

2. Outline and Installation Dimension (mm)

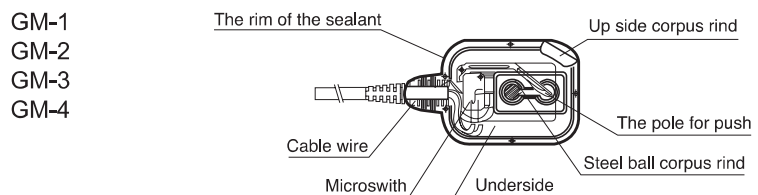
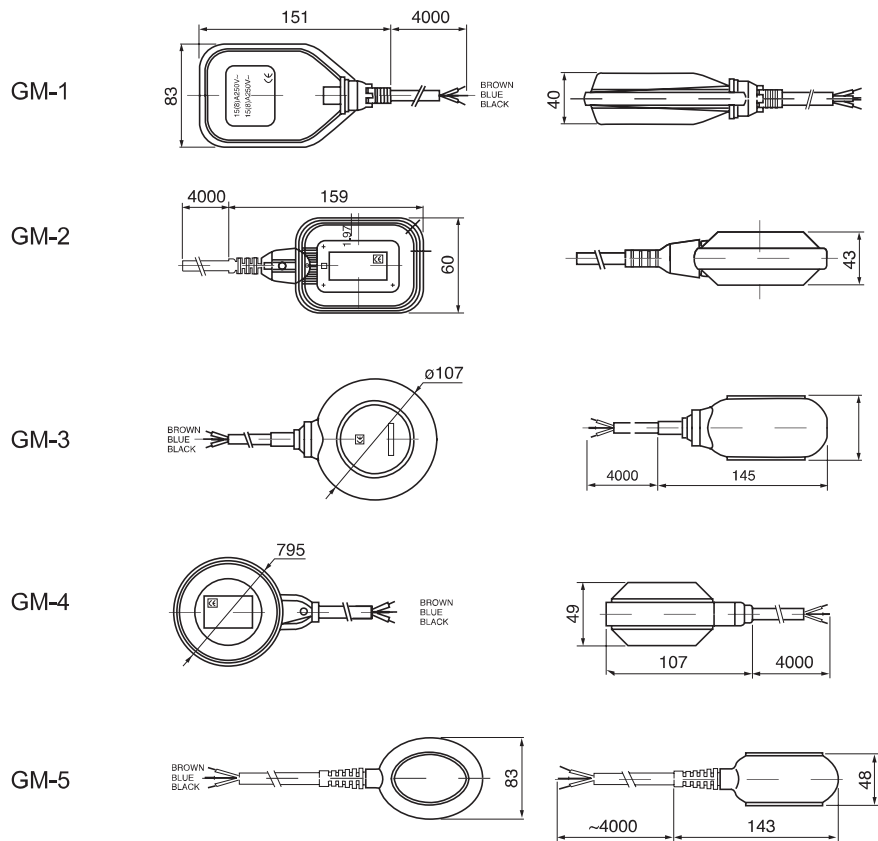

CHJ8 Inductive Proximity Sensor



		Output form		Flush	Non-flush
3-wire DC 10 -30V	NPN	NO	CHJ8-1.5N1	CHJ8M-2N1	
		NC	CHJ8-1.5N2	CHJ8M-2N2	
		NO+NC	-	-	
	PNP	NO	CHJ8-1.5P1	CHJ8M-2P1	
		NC	CHJ8-1.5P2	CHJ8M-2P2	
		NO+NC	-	-	
2-wire DC10-30V	NO	CHJ8-1.5D1	CHJ8M-2D1		
	NC	CHJ8-1.5D2	CHJ8M-2D2		
2-wire AC100-240V	NO	CHJ8-1.5A1	CHJ8M-2A1		
	NC	CHJ8-1.5A2	CHJ8M-2A2		
Sensing distance			1.5mm±10%	2mm±10%	

CHJ12 Inductive Proximity Sensor

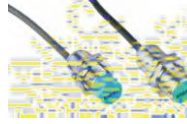

		Output form		Flush	Non-flush
3-wire DC 10 -30V	NPN	NO	CHJ12-2N1	CHJ12M-4N1	
		NC	CHJ12-2N2	CHJ12M-4N2	
		NO+NC	CHJ12-2N4	CHJ12M-4N4	
	PNP	NO	CHJ12-2P1	CHJ12M-4P1	
		NC	CHJ12-2P2	CHJ12M-4P2	
		NO+NC	CHJ12-2P4	CHJ12M-4P4	
2-wire DC10-30V	NO	CHJ12-2D1	CHJ12M-4D1		
	NC	CHJ12-2D2	CHJ12M-4D2		
2-wire AC100-240V	NO	CHJ12-2A1	CHJ12M-4A1		
	NC	CHJ12-2A2	CHJ12M-4A2		
Sensing distance			2mm±10%	4mm±10%	

CHJ18 Inductive Proximity Sensor

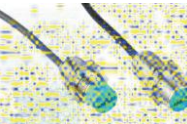

		Output form		Flush	Non-flush
3-wire DC 10 -30V	NPN	NO	CHJ18-5N1	CHJ18M-10N1	
		NC	CHJ18-5N2	CHJ18M-10N2	
		NO+NC	CHJ18-5N4	CHJ18M-10N4	
	PNP	NO	CHJ18-5P1	CHJ18M-10P1	
		NC	CHJ18-5P2	CHJ18M-10P2	
		NO+NC	CHJ18-5P4	CHJ18M-10P4	
2-wire DC10-30V	NO	CHJ18-5D1	CHJ18M-10D1		
	NC	CHJ18-5D2	CHJ18M-10D2		
2-wire AC100-240V	NO	CHJ18-5A1	CHJ18M-10A1		
	NC	CHJ18-5A2	CHJ18M-10A2		
Sensing distance			5mm±10%	10mm±10%	

CHJ30 Inductive Proximity Sensor



		Output form		Flush	Non-flush
3-wire DC 10 -30V	NPN	NO	CHJ30-10N1	CHJ30M-15N1	
		NC	CHJ30-10N2	CHJ30M-15N2	
		NO+NC	CHJ30-10N4	CHJ30M-15N4	
	PNP	NO	CHJ30-10P1	CHJ30M-15P1	
		NC	CHJ30-10P2	CHJ30M-15P2	
		NO+NC	CHJ30-10P4	CHJ30M-15P4	
2-wire DC10-30V	NO	CHJ30-10D1	CHJ30M-15D1		
	NC	CHJ30-10D2	CHJ30M-15D2		
2-wire AC100-240V	NO	CHJ30-10A1	CHJ30M-15A1		
	NC	CHJ30-10A2	CHJ30M-15A2		
Sensing distance			10mm±10%	15mm±10%	

CHJ8-H Connector type proximity sensor



L-shape Straight connector

Connector cable should be ordered separately(Convention 2m)

		Output form		Flush	Non-flush
3-wire DC 10 -30V	NPN	NO	CHJ8-1.5N1-H	CHJ8M-2N1-H	
		NC	CHJ8-1.5N2-H	CHJ8M-2N2-H	
		NO+NC	-	-	
	PNP	NO	CHJ8-1.5P1-H	CHJ8M-2P1-H	
		NC	CHJ8-1.5P2-H	CHJ8M-2P2-H	
		NO+NC	-	-	
2-wire DC10-30V	NO	CHJ8-1.5D1-H	CHJ8M-2D1-H		
	NC	CHJ8-1.5D2-H	CHJ8M-2D2-H		
2-wire AC100-240V	NO	CHJ8-1.5A1-H	CHJ8M-2A1-H		
	NC	CHJ8-1.5A2-H	CHJ8M-2A2-H		
Sensing distance			1.5mm±10%	2mm±10%	

CHJ12-H Connector type proximity sensor



L-shape Straight connector

Connector cable should be ordered separately(Convention 2m)

		Output form		Flush	Non-flush
3-wire DC 10 -30V	NPN	NO	CHJ12-2N1-H	CHJ12M-4N1-H	
		NC	CHJ12-2N2-H	CHJ12M-4N2-H	
		NO+NC	CHJ12-2N4-H	CHJ12M-4N4-H	
	PNP	NO	CHJ12-2P1-H	CHJ12M-4P1-H	
		NC	CHJ12-2P2-H	CHJ12M-4P2-H	
		NO+NC	CHJ12-2P4-H	CHJ12M-4P4-H	
2-wire DC10-30V	NO	CHJ12-2D1-H	CHJ12M-4D1-H		
	NC	CHJ12-2D2-H	CHJ12M-4D2-H		
2-wire AC100-240V	NO	CHJ12-2A1-H	CHJ12M-4A1-H		
	NC	CHJ12-2A2-H	CHJ12M-4A2-H		
Sensing distance			2mm±10%	4mm±10%	

CHJ18-H Connector type proximity sensor



L-shape Straight connector

Connector cable should be ordered separately(Convention 2m)

		Output form		Flush	Non-flush
3-wire DC 10 -30V	NPN	NO	CHJ18-5N1-H	CHJ18M-10N1-H	
		NC	CHJ18-5N2-H	CHJ18M-10N2-H	
		NO+NC	CHJ18-5N4-H	CHJ18M-10N4-H	
	PNP	NO	CHJ18-5P1-H	CHJ18M-10P1-H	
		NC	CHJ18-5P2-H	CHJ18M-10P2-H	
		NO+NC	CHJ18-5P4-H	CHJ18M-10P4-H	
2-wire DC10-30V	NO	CHJ18-5D1-H	CHJ18M-10D1-H		
	NC	CHJ18-5D2-H	CHJ18M-10D2-H		
2-wire AC100-240V	NO	CHJ18-5A1-H	CHJ18M-10A1-H		
	NC	CHJ18-5A2-H	CHJ18M-10A2-H		
Sensing distance			5mm±10%	10mm±10%	

CHJ30-H Connector type proximity sensor



L-shape Straight connector

Connector cable should be ordered separately(Convention 2m)

		Output form		Flush	Non-flush
3-wire DC 10 -30V	NPN	NO	CHJ30-10N1	CHJ30M-15N1	
		NC	CHJ30-10N2	CHJ30M-15N2	
		NO+NC	CHJ30-10N4	CHJ30M-15N4	
	PNP	NO	CHJ30-10P1	CHJ30M-15P1	
		NC	CHJ30-10P2	CHJ30M-15P2	
		NO+NC	CHJ30-10P4	CHJ30M-15P4	
2-wire DC10-30V	NO	CHJ30-10D1	CHJ30M-15D1		
	NC	CHJ30-10D2	CHJ30M-15D2		
2-wire AC100-240V	NO	CHJ30-10A1	CHJ30M-15A1		
	NC	CHJ30-10A2	CHJ30M-15A2		
Sensing distance			10mm±10%	15mm±10%	

CHJ17M, CHJ25M Rectangular type inductive

		Output form		Flush	Non-flush
3-wire DC 10 -30V	NPN	NO	CHJ17M-5N1	CHJ25M-8N1	
		NC	CHJ17M-5N2	CHJ25M-8N2	
		NO+NC	-	-	
	PNP	NO	CHJ17M-5P1	CHJ25M-8P1	
		NC	CHJ17M-5P2	CHJ25M-8P2	
		NO+NC	-	-	
3-wire DC10-30V	NO	CHJ17M-5D1	CHJ25M-8D1		
	NC	CHJ17M-5D2	CHJ25M-8D2		
3-wire AC100-240V	NO	CHJ17M-5A1	CHJ25M-8A1		
	NC	CHJ17M-5A2	CHJ25M-8A2		
		Sensing distance	5mm±10%	8mm±10%	

Size: 17×17×28mm
Size: 25×25×38mm

CHJ17,CHJ25 Flat type inductive proximity sensor

		Output form		Flush	Non-flush
3-wire DC 10 -30V	NPN	NO	CHJ17-5N1	CHJ25-10N1	
		NC	CHJ17-5N2	CHJ25-10N2	
		NO+NC	-	-	
	PNP	NO	CHJ17-5P1	CHJ25-10P1	
		NC	CHJ17-5P2	CHJ25-10P2	
		NO+NC	-	-	
2-wire DC10-30V	NO	CHJ17-5D1	CHJ25-10D1		
	NC	CHJ17-5D2	CHJ25-10D2		
2-wire AC100-240V	NO	CHJ17-5A1	CHJ25-10A1		
	NC	CHJ17-5A2	CHJ25-10A2		
		Sensing distance	5mm±10%	10mm±10%	

Size: 18×30×10mm
Size: 30×45×12mm

CHJ42M,CHJ48M Plane installation inductive proximity sensor

		Output form	Non-flush		
3-wire DC 10 -30V	NPN	NO	CHJ42M-18N1	CHJ48M-20N1	
		NC	CHJ42M-18N2	CHJ48M-20N2	
		NO+NC	CHJ42M-18N4	CHJ48M-20N4	
	PNP	NO	CHJ42M-18P1	CHJ48M-20P1	
		NC	CHJ42M-18P2	CHJ48M-20P2	
		NO+NC	CHJ42M-18P4	CHJ48M-20P4	
2-wire DC10-30V	NO	CHJ42M-18D1	CHJ48M-20D1		
	NC	CHJ42M-18D2	CHJ48M-20D2		
2-wire AC100-240V	NO	CHJ42M-18A1	CHJ48M-20A1		
	NC	CHJ42M-18A2	CHJ48M-20A2		
		Sensing distance	18mm±10%	20mm±10%	



CHC18M,CHC30M,CHC34M Capacitive proximity sensor

		Output form		Non-flush		
3-wire DC 10 -30V	NPN	NO	CHC18M-8N1	CHC30M-15N1	CHC34M-25N1	
		NC	CHC18M-8N2	CHC30M-15N2	CHC34M-25N2	
		NO+NC	CHC18M-8P1	CHC30M-15P1	CHC34M-25P1	
	PNP	NO	CHC18M-8P2	CHC30M-15P2	CHC34M-25P2	
		NC	CHC18M-8P2	CHC30M-15P2	CHC34M-25P2	
		NO+NC	CHC18M-8P4	CHC30M-15P4	CHC34M-25P4	
2-wire DC10-30V	NO	CHC18M-8D1	CHC30M-15D1	CHC34M-25D1		
	NC	CHC18M-8D2	CHC30M-15D2	CHC34M-25D2		
2-wire AC100-240V	NO	CHC18M-8A1	CHC30M-15A1	CHC34M-25A1		
	NC	CHC18M-8A2	CHC30M-15A2	CHC34M-25A2		
		Sensing distance	8mm±10%	15mm±10%	25mm±10%	



Diameter: Ø18, Ø30, Ø34

LJM8 Short cylindrical inductive proximity sensor

		Output form		Flush	Non-flush
3-wire DC 6 -36V	NPN	NO	LJM8-1.5N1	LJM8M-2N1	
		NC	LJM8-1.5N2	LJM8M-2N2	
		NO+NC	-	-	
	PNP	NO	LJM8-1.5P1	LJM8M-2P1	
		NC	LJM8-1.5P2	LJM8M-2P2	
		NO+NC	-	-	
2-wire DC6-36V	NO	LJM8-1.5D1	LJM8M-2D1		
	NC	-	-		
2-wire AC90-250V	NO	-	-		
	NC	-	-		
		Sensing distance	1.5mm±15%	2mm±15%	

Diameter: Ø8 Length: 30mm

LJM12 Short cylindrical inductive proximity sensor

		Output form		Flush	Non-flush
3-wire DC 6 -36V	NPN	NO	LJM12-2N1	LJM12M-5N1	
		NC	LJM12-2N2	LJM12M-5N2	
		NO+NC	LJM12-2N4	LJM12M-5N4	
	PNP	NO	LJM12-2P1	LJM12M-5P1	
		NC	LJM12-2P2	LJM12M-5P2	
		NO+NC	LJM12-2P4	LJM12M-5P4	
2-wire DC6-36V	NO	LJM12-2D1	LJM12M-5D1		
	NC	LJM12-2D2	LJM12M-5D2		
2-wire AC90-250V	NO	LJM12-2A1	LJM12M-5A1		
	NC	LJM12-2A2	LJM12M-5A2		
		Sensing distance	2mm±15%	5mm±15%	

Diameter: Ø12 Length: 45mm

LJM18 Short cylindrical inductive proximity sensor

		Output form		Flush	Non-flush
3-wire DC 6 -36V	NPN	NO	LJM18-5N1	LJM18M-10N1	
		NC	LJM18-5N2	LJM18M-10N2	
		NO+NC	LJM18-5N4	LJM18M-10N4	
	PNP	NO	LJM18-5P1	LJM18M-10P1	
		NC	LJM18-5P2	LJM18M-10P2	
		NO+NC	LJM18-5P4	LJM18M-10P4	
2-wire DC6-36V	NO	LJM18-5D1	LJM18M-10D1		
	NC	LJM18-5D2	LJM18M-10D2		
2-wire AC90-250V	NO	LJM18-5A1	LJM18M-10A1		
	NC	LJM18-5A2	LJM18M-10A2		
		Sensing distance	5mm±15%	10mm±15%	

Diameter: Ø18 Length: 50mm

LJM30 Short cylindrical inductive proximity sensor

		Output form		Flush	Non-flush
3-wire DC 6 -36V	NPN	NO	LJM30-10N1	LJM30M-18N1	
		NC	LJM30-10N2	LJM30M-18N2	
		NO+NC	LJM30-10N4	LJM30M-18N4	
	PNP	NO	LJM30-10P1	LJM30M-18P1	
		NC	LJM30-10P2	LJM30M-18P2	
		NO+NC	LJM30-10P4	LJM30M-18P4	
2-wire DC6-36V	NO	LJM30-10D1	LJM30M-18D1		
	NC	LJM30-10D2	LJM30M-18D2		
2-wire AC90-250V	NO	LJM30-10A1	LJM30M-18A1		
	NC	LJM30-10A2	LJM30M-18A2		
		Sensing distance	10mm±15%	18mm±15%	

Diameter: Ø30 Length: 50mm

LJA8 Long cylindrical inductive proximity sensor



		Output form		Flush	Non-flush
3-wire DC 6 -36V	NPN	NO	LJA8-1.5N1	LJA8M-2N1	
		NC	LJA8-1.5N2	LJA8M-2N2	
		NO+NC	-	-	
	PNP	NO	LJA8-1.5P1	LJA8M-2P1	
		NC	LJA8-1.5P2	LJA8M-2P2	
		NO+NC	-	-	
2-wire DC6-36V		NO	LJA8-1.5D1	LJA8M-2D1	
		NC	-	-	
2-wire AC90-250V		NO	LJA8-1.5A1	LJA8M-2A1	
		NC	LJA8-1.5A2	LJA8M-2A2	
Sensing distance			1.5mm±15%	2mm±15%	

Diameter: Ø8 Length: 40mm

LJA12 Long cylindrical inductive proximity sensor



		Output form		Flush	Non-flush
3-wire DC 6 -36V	NPN	NO	LJA12-2N1	LJA12M-5N1	
		NC	LJA12-2N2	LJA12M-5N2	
		NO+NC	LJA12-2N4	LJA12M-5N4	
	PNP	NO	LJA12-2P1	LJA12M-5P1	
		NC	LJA12-2P2	LJA12M-5P2	
		NO+NC	LJA12-2P4	LJA12M-5P4	
2-wire DC6-36V		NO	LJA12-2D1	LJA12M-5D1	
		NC	LJA12-2D2	LJA12M-5D2	
2-wire AC90-250V		NO	LJA12-2A1	LJA12M-5A1	
		NC	LJA12-2A2	LJA12M-5A2	
Sensing distance			2mm±15%	5mm±15%	

Diameter: Ø12 Length: 50mm

LJA18 Long cylindrical inductive proximity sensor



		Output form		Flush	Non-flush
3-wire DC 6 -36V	NPN	NO	LJA18-5N1	LJA18M-10N1	
		NC	LJA18-5N2	LJA18M-10N2	
		NO+NC	LJA18-5N4	LJA18M-10N4	
	PNP	NO	LJA18-5P1	LJA18M-10P1	
		NC	LJA18-5P2	LJA18M-10P2	
		NO+NC	LJA18-5P4	LJA18M-10P4	
2-wire DC6-36V		NO	LJA18-5D1	LJA18M-10D1	
		NC	LJA18-5D2	LJA18M-10D2	
2-wire AC90-250V		NO	LJA18-5A1	LJA18M-10A1	
		NC	LJA18-5A2	LJA18M-10A2	
Sensing distance			5mm±15%	10mm±15%	

Diameter: Ø18 Length: 52mm

LJA30 Long cylindrical inductive proximity sensor



		Output form		Flush	Non-flush
3-wire DC 6 -36V	NPN	NO	LJA30-10N1	LJA30M-18N1	
		NC	LJA30-10N2	LJA30M-18N2	
		NO+NC	LJA30-10N4	LJA30M-18N4	
	PNP	NO	LJA30-10P1	LJA30M-18P1	
		NC	LJA30-10P2	LJA30M-18P2	
		NO+NC	LJA30-10P4	LJA30M-18P4	
2-wire DC6-36V		NO	LJA30-10D1	LJA30M-18D1	
		NC	LJA30-10D2	LJA30M-18D2	
2-wire AC90-250V		NO	LJA30-10A1	LJA30M-18A1	
		NC	LJA30-10A2	LJA30M-18A2	
Sensing distance			10mm±15%	18mm±15%	

Diameter: Ø30 Length: 52mm

CJM18M,CJM24M Capacitive proximity sensor



		Output form		Non-flush	
3-wire DC 6 -36V	NPN	NO	CJM18M-8N1	CJM24M-10N1	
		NC	CJM18M-8N2	CJM24M-10N2	
		NO+NC	CJM18M-8N4	CJM24M-10N4	
	PNP	NO	CJM18M-8P1	CJM24M-10P1	
		NC	CJM18M-8P2	CJM24M-10P2	
		NO+NC	CJM18M-8P4	CJM24M-10P4	
2-wire DC6-36V		NO	CJM18M-8D1	CJM24M-10D1	
		NC	CJM18M-8D2	CJM24M-10D2	
2-wire AC90-250V		NO	CJM18M-8A1	CJM24M-10A1	
		NC	CJM18M-8A2	CJM24M-10A2	
Sensing distance			8mm±10%	10mm±10%	

Diameter: Ø18,Ø24
Plastic housing is also available

CJM30M,CJM34M Capacitive proximity sensor



		Output form		Non-flush	
3-wire DC 6 -36V	NPN	NO	CJM30M-15N1	CJM34M-25N1	
		NC	CJM30M-15N2	CJM34M-25N2	
		NO+NC	CJM30M-15N4	CJM34M-25N4	
	PNP	NO	CJM30M-15P1	CJM34M-25P1	
		NC	CJM30M-15P2	CJM34M-25P2	
		NO+NC	CJM30M-15P4	CJM34M-25P4	
2-wire DC6-36V		NO	CJM30M-15D1	CJM34M-25D1	
		NC	CJM30M-15D2	CJM34M-25D2	
2-wire AC90-250V		NO	CJM30M-15A1	CJM34M-25A1	
		NC	CJM30M-15A2	CJM34M-25A2	
Sensing distance			15mm±10%	25mm±10%	

Diameter: Ø30,Ø34
Plastic housing is also available

LJB25M,LJB40M Rectangular inductive proximity sensor



		Output form		Non-flush	
3-wire DC 6 -36V	NPN	NO	LJB25M-5N1	LJB40M-20N1	
		NC	LJB25M-5N2	LJB40M-20N2	
		NO+NC	LJB25M-5N4	LJB40M-20N4	
	PNP	NO	LJB25M-5P1	LJB40M-20P1	
		NC	LJB25M-5P2	LJB40M-20P2	
		NO+NC	LJB25M-5P4	LJB40M-20P4	
2-wire DC6-36V		NO	LJB25M-5D1	LJB40M-20D1	
		NC	LJB25M-5D2	LJB40M-20D2	
2-wire AC90-250V		NO	LJB25M-5A1	LJB40M-20A1	
		NC	LJB25M-5A2	LJB40M-20A2	
Sensing distance			5mm±15%	20mm±15%	

SN04 Rectangular inductive proximity sensor



		Output form		Flush	
3-wire DC 6 -36V	NPN	NO	SN04-N		
		NC	SN04-N2		
		NO+NC	-		
	PNP	NO	SN04-P		
		NC	SN04-P2		
		NO+NC	-		
2-wire DC6-36V		NO	SN04-E		
		NC	SN04-E2		
2-wire AC90-250V		NO	SN04-Y		
		NC	SN04-Y2		
Sensing distance			4mm±15%		

1081 Warning Light ø80

 Bulb/Revolving



Outer Size

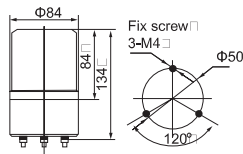

Color



Model	Voltage	Light power
LTE1081	DC12V	5W
LTE1081J	DC24V	
LTD1081	AC110V	
LTD1081J	AC220V	

1084 Warning Light ø80

 Bulb/Revolving



Outer Size

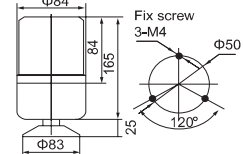

Color



Model	Voltage	Light power
LTE1084	DC12V DC24V AC110V AC220V	5W

1082 Warning Light ø80

 Bulb/Revolving



Outer Size

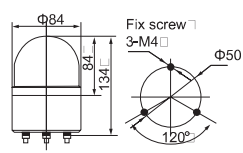

Color



Model	Voltage	Light power
LTE1082	DC12V DC24V	5W
LTE1082J	AC110V AC220V	

1101 Warning Light ø100

 Bulb/Revolving



Outer Size

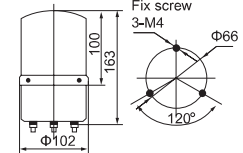

Color



Model	Voltage	Light power
LTE1101	DC12V	10W
LTE1101J	DC24V	
LTD1101	AC110V	
LTD1101J	AC220V	

2082 Warning Light ø80

 Bulb/Flashing



Outer Size

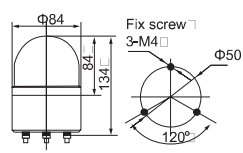

Color



Model	Voltage	Light power
LTE2082	DC12V DC24V	5W
LTE2082J	AC110V AC220V	

5101 Warning Light ø100

 LED/Strobe



Outer Size

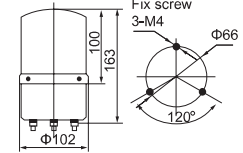

Color



Model	Voltage	Light power
LTE5101	DC12V DC24V	2W
LTE5101J	AC110V AC220V	

1083 Warning Light ø80

 Bulb/Revolving



Outer Size

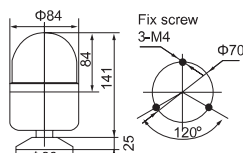

Color



Model	Voltage	Light power
LTE1083	DC12V DC24V AC110V AC220V	5W

1102 Warning Light ø100

 Bulb/Revolving



Outer Size

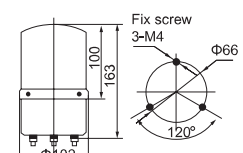

Color



Model	Voltage	Light power
LTE1102	DC12V DC24V	10W
LTE1102J	AC110V AC220V	

1103 Warning Light ø100

 Bulb/Revolving



Outer Size

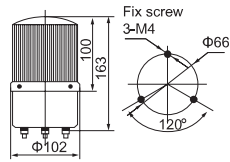

Color
Red
Yellow
Green
Blue

Model	Voltage	Light power
LTE1103	DC12V DC24V	10W
LTE1103J	AC110V AC220V	

1105 Warning Light ø100

 Bulb/Revolving



Outer Size

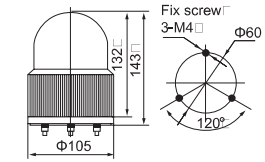

Color
Red
Yellow
Green
Blue

Model	Voltage	Light power
LTE1105	DC12V DC24V	5W
LTD1105	AC110V AC220V	

5103 Warning Light ø100

 LED/Strobe



Outer Size

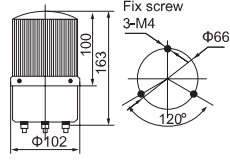

Color
Red
Yellow
Green
Blue

Model	Voltage	Light power
LTE5103	DC12V DC24V	2W
LTE5103J	AC110V AC220V	

1122 Warning Light ø120

 Bulb/Revolving



Outer Size

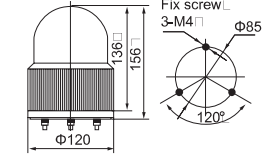

Color
Red
Yellow
Green
Blue

Model	Voltage	Light power
LTE1122	DC12V DC24V	10W
LTD1122	AC110V AC220V	

1104 Warning Light ø100

 Bulb/Revolving



Outer Size

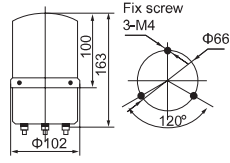

Color
Red
Yellow
Green
Blue

Model	Voltage	Light power
LTE1104	DC12V DC24V	10W
LTE1104J	AC110V AC220V	

1121 Warning Light ø120

 Bulb/Revolving



Outer Size

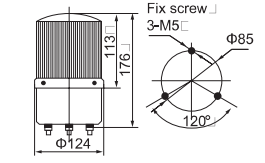

Color
Red
Yellow
Green
Blue

Model	Voltage	Light power
LTE1121	DC12V	10W
LTE1121J	DC24V	
LTD1121	AC110V	
LTD1121J	AC220V	

5104 Warning Light ø100

 LED/Strobe



Outer Size

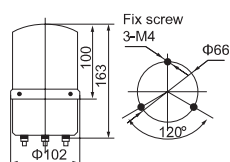

Color
Red
Yellow
Green
Blue

Model	Voltage	Light power
LTE5104	DC12V DC24V	2W
LTE5104J	AC110V AC220V	

5121 Warning Light ø120

 LED/Strobe



Outer Size

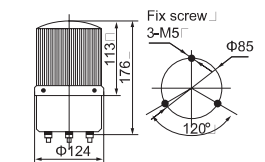

Color
Red
Yellow
Green
Blue

Model	Voltage	Light power
LTE5121	DC12V DC24V	2W
LTE5121J	AC110V AC220V	

1201 Warning Light

 Bulb/Revolving

Outer Size

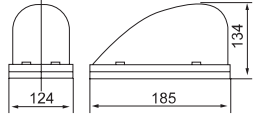

Color

- Red
- Yellow
- Blue



Model	Voltage	Light power
LTD1201	DC12V DC24V	23W

1181 Warning Light ø180

 Bulb/Revolving

Outer Size

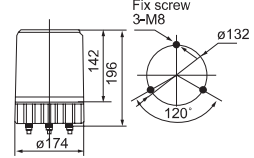

Color

- Red
- Yellow
- Blue



Model	Voltage	Light power
LTE1181	DC12V DC24V	35W
LTD1181	AC110V AC220V	

1201J Warning Light

 LED/Strobe

Outer Size

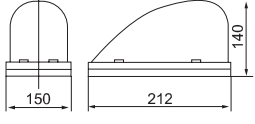

Color

- Red
- Yellow
- Blue



Model	Voltage	Light power
LTD1201J	DC12V DC24V	23W

5181 Warning Light ø180

 LED/Strobe

Outer Size

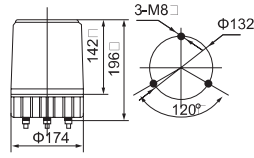

Color

- Red
- Yellow
- Blue



Model	Voltage	Light power
LTE5181	DC12V DC24V	3W
LTD5181	AC110V AC220V	

1161 Warning Light ø160

 Bulb/Revolving

Outer Size

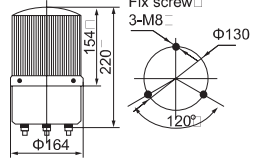

Color

- Red
- Yellow
- Green
- Blue



Model	Voltage	Light power
LTE1161	DC12V DC24V	35W
LTD1161	AC110V AC220V	

1191 Warning Light ø190

 Bulb/Revolving

Outer Size

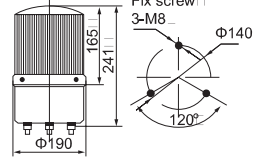

Color

- Red
- Yellow
- Green
- Blue



Model	Voltage	Light power
LTE1191	DC12V DC24V	55W
LTD1191	AC110V AC220V	

5161 Warning Light ø160

 LED/Strobe

Outer Size

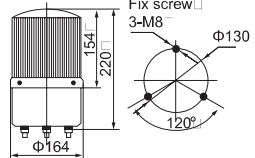

Color

- Red
- Yellow
- Green
- Blue



Model	Voltage	Light power
LTE5161	DC12V DC24V	3W
LTD5161	AC110V AC220V	

5191 Warning Light ø190

 LED/Strobe

Outer Size

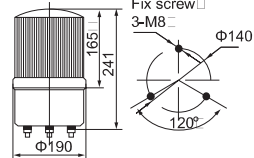

Color

- Red
- Yellow
- Green
- Blue



Model	Voltage	Light power
LTE5191	DC12V DC24V	3W
LTD5191	AC110V AC220V	

1121S Warning Light ø120



Bulb/Revolving



Outer Size

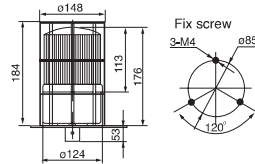

Color
Red
Yellow
Green
Blue

Model	Voltage	Light power
LTG1121S	DC12V DC24V AC110V AC220V	10W

5062 Flash Beacon ø70



Bulb/Flashing



Outer Size

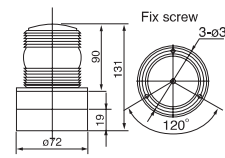

Color
Red
Yellow

Model	Voltage	Light power
LTD5062	DC6V	2W

1122S Warning Light ø120



Bulb/Revolving



Outer Size

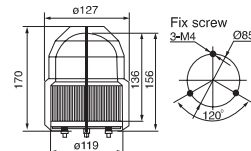

Color
Red
Yellow
Green
Blue

Model	Voltage	Light power
LTE1122S	DC12V DC24V AC110V AC220V	10W

5088 Flash Beacon ø80



Bulb/Flashing



Outer Size

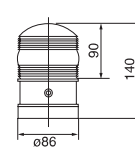

Color
Red
Yellow

Model	Voltage	Light power
LTD5088	DC6V	2W

1104 Warning Light ø100



Bulb/Revolving



Outer Size

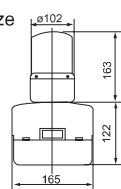

Color
Red
Yellow

Model	Voltage	Light power
LTB1104	DC6V	3W

2071 Flash Beacon ø70



Bulb/Flashing



Outer Size

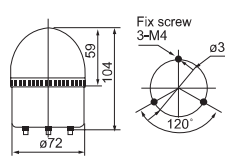

Color
Red
Yellow
Green
Blue

Model	Voltage	Light power
LTE2071	DC12V DC24V	15W
LTD2071	AC220V	

1102+ML Warning Light



Bulb/Revolving

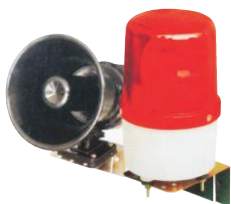

Outer Size

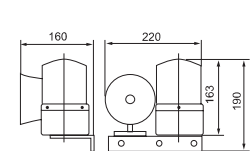

Color
Red
Yellow

Model	Voltage	Light power
LTE1102+ML	DC12V DC24V AC110V AC220V	30W

5071 Flash Beacon ø70



Bulb/Flashing



Outer Size

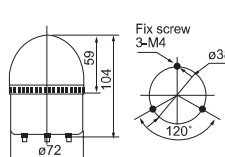

Color
Red
Yellow
Green
Blue

Model	Voltage	Light power
LTE5071	DC12V DC24V	2W
LTD5071	AC220V	

3051 Strobe Beacon

 Xenon Strobe

Outer Size

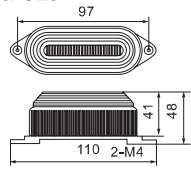

Color

- Red
- Yellow
- Green
- Blue
- White

Model	Voltage	Light power
LTE3051	DC12V DC24V AC220V	10W



3072 Strobe Beacon ø80

 Xenon Strobe

Outer Size

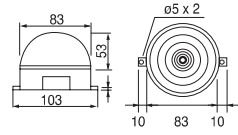

Color

- Red
- Yellow
- Green
- Blue
- White

Model	Voltage	Light power
LTE3072	DC12V DC24V AC220V	10W



5051 Strobe Beacon

 LED/Flashing

Outer Size

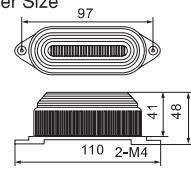

Color

- Red
- Yellow
- Green
- Blue
- White

Model	Voltage	Light power
LTE5051	DC12V DC24V AC220V	2W



5072 Strobe Beacon ø80

 LED/Flashing

Outer Size

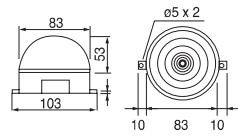

Color

- Red
- Yellow
- Green
- Blue
- White

Model	Voltage	Light power
LTE5072	DC12V DC24V AC220V	2W



3061 Strobe Beacon ø70

 Xenon Strobe

Outer Size

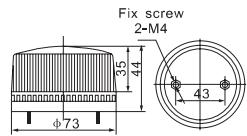

Color

- Red
- Yellow
- Green
- Blue

Model	Voltage	Light power
LTE6061	DC12V DC24V AC220V	10W



3073 Strobe Beacon ø90

 Xenon Strobe

Outer Size

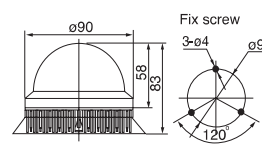

Color

- Red
- Yellow
- Blue

Model	Voltage	Light power
LTE3073	DC12V DC24V AC220V	20W



5061 Strobe Beacon ø70

 LED/Flashing

Outer Size

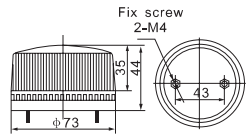

Color

- Red
- Yellow
- Green
- Blue

Model	Voltage	Light power
LTE5061	DC12V DC24V AC220V	2W



5073 Strobe Beacon ø90

 LED/Flashing

Outer Size

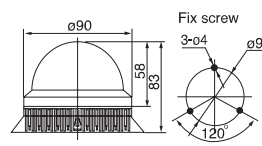

Color

- Red
- Yellow
- Blue

Model	Voltage	Light power
LTE5073	DC12V DC24V AC220V	2W



216 Multi-Level Rotator(Signal Tower)

 Bulb Steady Burn
Flashing



Outer Size

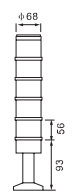

Color
Red
Yellow
Green
Blue
White

Model	Voltage	Light power	Function
LTA216-1	DC12V	5W	T-Steady burn
LTA216-2	DC24V	10W	
LTA216-3	AC110V	15W	W-Flash
LTA216-4	AC220V	20W	J-With buzzer

204 Signal Tower ø40

 Bulb Steady Burn
Flashing



Outer Size

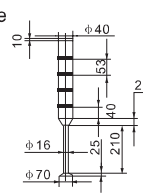

Color
Red
Yellow
Green
Blue

Model	Voltage	Light power	Function
LTA204-1		3W	T-Steady burn
LTA204-2	DC12V	6W	
LTA204-3	DC24V	9W	W-Flash
LTA204-4		12W	J-With buzzer

209 Multi-Level Rotator(Signal Tower)

 Bulb Steady Burn
Flashing



Outer Size

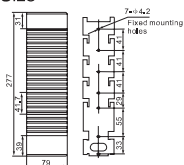

Color
Red
Yellow
Green
Blue
White

Model	Voltage	Light power
LTA209-1	DC12V	5W
LTA209-2	DC24V	10W
LTA209-3	AC110V	15W
LTA209-4	AC220V	20W

205 Signal Tower ø52

 Bulb Steady Burn
Flashing



Outer Size

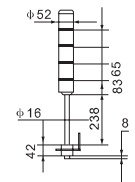

Color
Red
Yellow
Green
Blue
White

Model	Voltage	Light power	Function
LTA205-1		5W	T-Steady burn
LTA205-2	DC12V	10W	
LTA205-3	DC24V	15W	W-Flash
LTA205-4	AC110V	20W	J-With buzzer
LTA205-5	AC220V	25W	

117 Multi-Level Rotator(Signal Tower)

 Bulb/Revolving



Outer Size

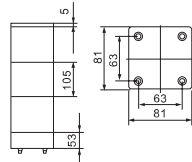

Color
Red
Yellow
Green

Model	Voltage	Lightpower	Function
LTA117-1	DC12V	5W	J-With buzzer
LTA117-2	DC24V	10W	
LTA117-3	AC110V	15W	

505 Signal Tower ø52

 Bulb Steady Burn
Flashing



Outer Size

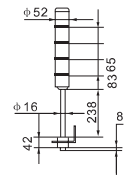

Color
Red
Yellow
Green
Blue
White

Model	Voltage	Lightpower	Function
LTA505-1		2W	T-Steady burn
LTA505-2	DC12V	4W	
LTA505-3	DC24V	6W	W-Flash
LTA505-4	AC110V	8W	J-With buzzer
LTA505-5	AC220V	10W	

203 Signal Tower ø40

 Bulb Steady Burn
Flashing



Outer Size

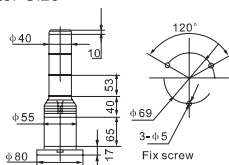

Color
Red
Yellow
Green
Blue

Model	Voltage	Light power	Function
LTA203-1	DC12V	3W	T-Steady burn
LTA203-2	DC24V	6W	
LTA203-3	AC110V	9W	W-Flash
LTA203-4	AC220V	12W	J-With buzzer

506 Signal Tower ø55

 Bulb Steady Burn
Flashing



Outer Size

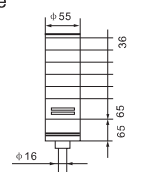

Color
Red
Yellow
Green
Blue
White

Model	Voltage	Light power	Function
LTA506-1		2W	T-Steady burn
LTA506-2	DC12V	4W	
LTA506-3	DC24V	6W	W-Flash
LTA506-4	AC110V	8W	J-With buzzer
LTA506-5	AC220V	10W	

5001 Signal Tower ø55

LED Steady Burn/
Flashing(Three Colors)

Note:2-3 kinds of colors
can be transformed in
a lamp's lens



Outer Size

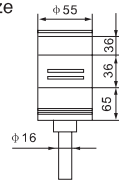

Color



Model	Voltage	Light power	Function
LTA5001	DC12V DC24V AC110V AC220V	6W	T-Steady burn W-Flash J-With buzzer

520 Signal Tower ø98

LED Steady Burn
Flashing

Outer Size

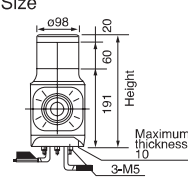

Color



Model	Voltage	Light power	Function
LTA520-1J	DC12V	23W	T-Steady burn
LTA520-2J	DC24V	26W	W-Flash
LTA520-3J	AC110V AC220V	29W	J-With buzzer

207 Signal Tower ø55

Bulb Steady Burn
Flashing



Outer Size

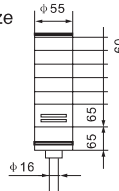

Color



Model	Voltage	Light power	Function
LTA207-1	DC12V	5W	T-Steady burn
LTA207-2	DC24V	10W	W-Flash
LTA207-3	AC110V	15W	J-With buzzer
LTA207-4	AC220V	20W	
LTA207-5		25W	

Stack Light's Mounting Base

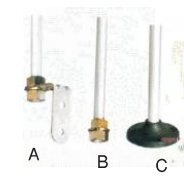

Outer Size

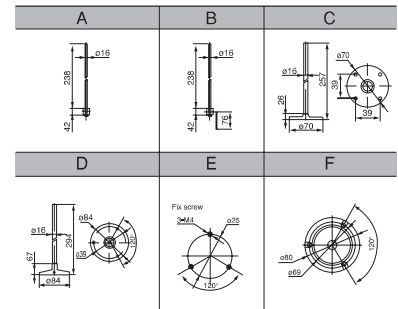

507 Signal Tower ø55

LED Steady Burn
Flashing



Outer Size

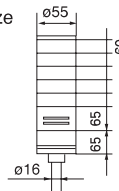

Color



Model	Voltage	Light power	Function
LTA507-1	DC12V	2W	T-Steady burn
LTA507-2	DC24V	4W	W-Flash
LTA507-3	AC110V	6W	J-With buzzer
LTA507-4	AC220V	8W	
LTA507-5		10W	

131 Road Block Traffic Light

Xenon Strobe
LED/Flashing
Bulb/Flashing



Outer Size

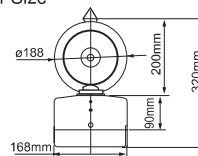

Color



Model	Voltage	Light power
LTB2131	DC6V	Halogen Bulb
LTB5131		LED
LTB3131		Xenon Tube

508 Signal Tower ø98

LED Steady Burn
Flashing



Outer Size

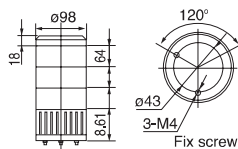

Color



Model	Voltage	Light power	Function
LTA508-1	DC12V	3W	T-Steady burn
LTA508-2	DC24V	6W	W-Flash
LTA508-3	AC110V AC220V	9W	J-With buzzer

5132 Road Block Traffic Light

LED/Flashing



Outer Size

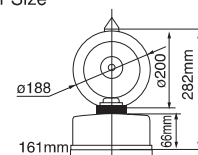

Color



Model	Voltage	Light power
LTB5132	DC6V	LED

5133 Road Block Traffic Light

LED/Flashing



Outer Size

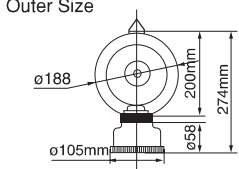

Color
Red
Yellow

Model	Voltage	Light power
LTB5133	DC3V	LED

5064 Road Block Traffic Light

LED/Flashing



Outer Size

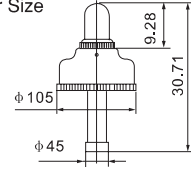

Color
Red
Yellow

Model	Voltage	Light power
LTB5064	DC3V	LED

5184 Road Block Traffic Light

LED/Flashing



Outer Size

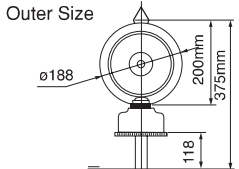

Color
Red
Yellow

Model	Voltage	Light power
LTB5184	DC3V	LED

5088 Road Block Traffic Light ø86

LED/Flashing



Outer Size

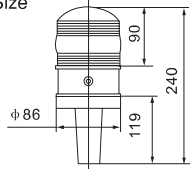

Color
Red
Yellow

Model	Voltage	Light power
LTB5088	DC6V	LED

5185 Road Block Traffic Light

LED/Flashing



Outer Size

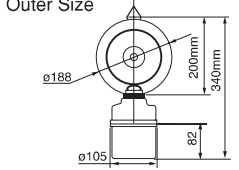

Color
Red
Yellow

Model	Voltage	Light power
LTB5185	DC6V	LED

MS-190 Mini Motor Siren

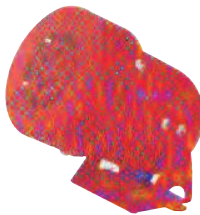
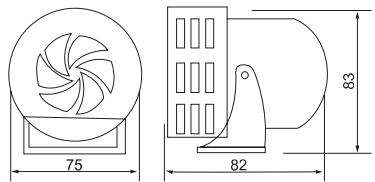
Voltage: DC12V, 24V, AC110V, 220V

5063 Road Block Traffic Light

LED/Flashing



Outer Size

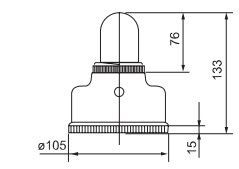

Color
Red
Yellow

Model	Voltage	Light power
LTB5063	DC3V	LED

MS-290 Motor Siren

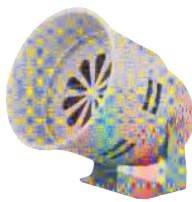
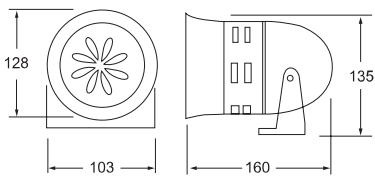
Voltage: DC12V, 24V, AC110V, 220V

MS-390 Motor Siren

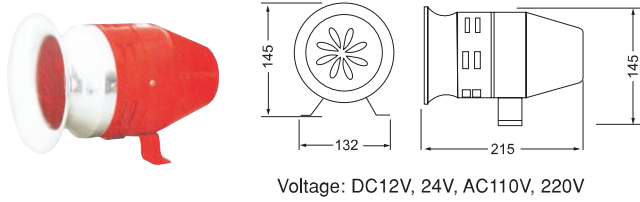

Voltage: DC12V, 24V, AC110V, 220V

KRB-P80 Buzzer

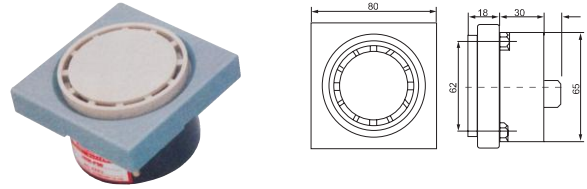

Voltage: DC12V, 24V, AC110V, 220V

MS-490 Double Motor Siren

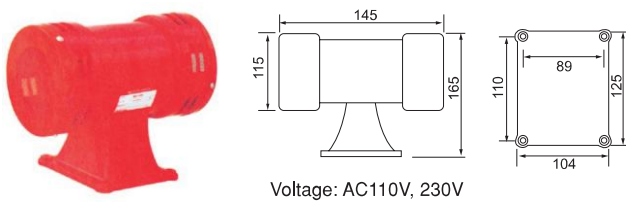

Voltage: AC110V, 230V

KRB-N80 Buzzer

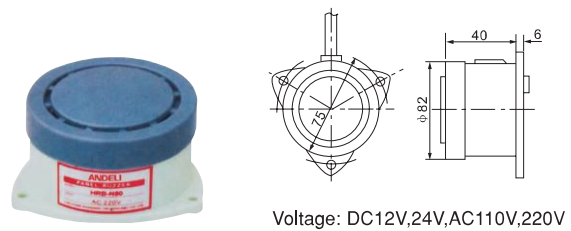

Voltage: DC12V,24V,AC110V,220V

MS-590 Double Motor Siren

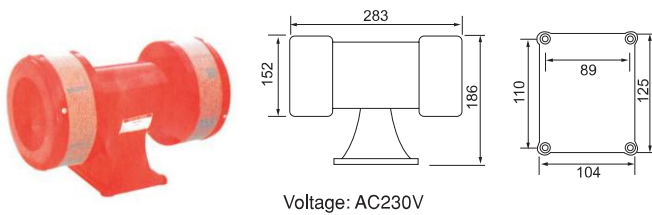

Voltage: AC230V

BJ-1 Buzzer

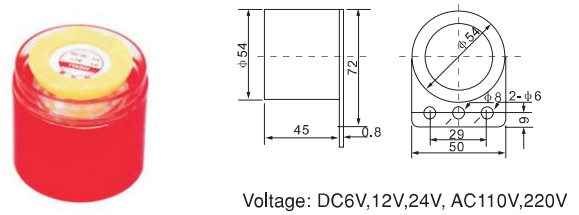

Voltage: DC6V,12V,24V, AC110V,220V

HPB-KM Buzzer

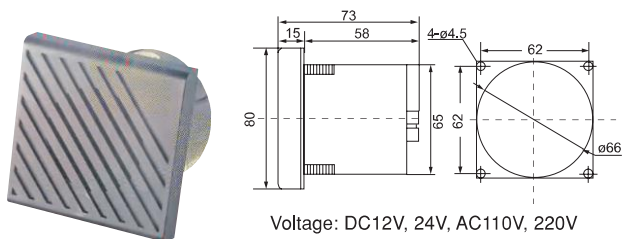

Voltage: DC12V, 24V, AC110V, 220V

FMQ-3025 Buzzer

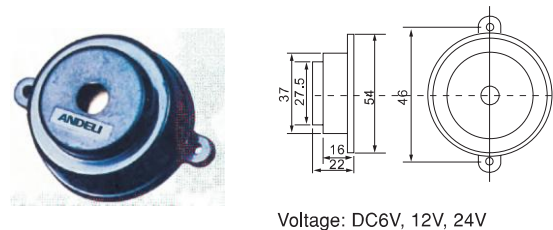

Voltage: DC6V, 12V, 24V

HPB-PS30 Buzzer

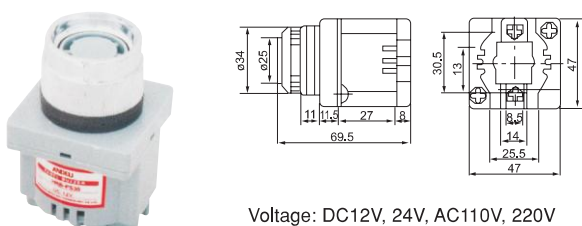

Voltage: DC12V, 24V, AC110V, 220V

FMQ-5123 Buzzer

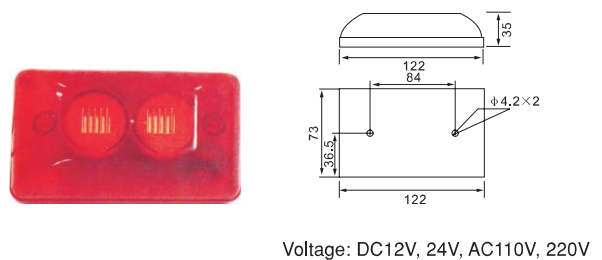

Voltage: DC12V, 24V, AC110V, 220V

Bell

1.Specification



YW01-9V

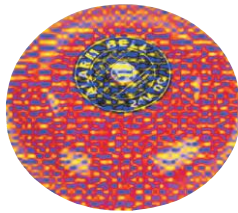

F2-8"



UC4



SCF-100MM

Model	Voltage	Size	Diz(mm)
YW01-9V	9V	6	150
YW04-9V	9V	4	100
F2-4"	DC6V DC12V DC24V AC110V AC120V AC130V AC220V AC230V AC240V	4	100
F2-6"		6	150
F2-8"		8	200
F2-10"		10	250
SB1-55MM	AC110V AC120V AC130V AC220V AC230V AC240V	2	ø55
SB1-75MM		3	ø75
SB1-100MM		4	ø100
SB1-150MM		6	ø150
SB1-200MM		8	ø200
SB1-250MM		10	ø250
SB1-300MM		12	ø300
UC4-55MM	DC6V DC12V DC24V AC110V AC120V AC130V AC220V AC230V AC240V	2	ø55
UC4-75MM		3	ø75
UC4-100MM		4	ø100
UC4-150MM		6	ø150
UC4-200MM		8	ø200
UC4-250MM		10	ø250
UC4-300MM		12	ø300
UC5-75MM	AC110V AC120V AC130V AC220V AC230V AC240V	3	ø75
SCF-75MM	AC110V AC120V AC130V AC220V AC230V AC240V	3	ø75
SCF-100MM		4	ø100
SCF-125MM		5	ø125
SCF-150MM		6	ø150
SCF-200MM		8	ø200
SCF-250MM		10	ø250
SCF-300MM		12	ø300