

Catalogue

Wenzhou Xucky Electric Co.,Ltd

www.xucky.com



Terminal Cable Tie Clips Cable Gland
Cabinet Lock Axial Fan

SC Copper Cable Lug

1. Application

SC copper cable lugs are suitable for the connection of copper conductors (section 1.5-1000mm²) in power cable with electronic equipment. They are made of 99.9% pure tin coated copper tube T2. Working temperature is from -55°C to +150°C.

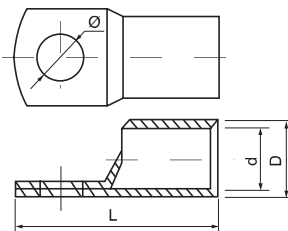

2. Specification

Type	Ø	D	d	L
SC-1.5	f4, f5	3.5	1.8	18
SC-2.5	f4, f5, f6	4	2.5	19
SC-4	f5, f6	4.8	3.1	21
SC-6	f5, f6, f8	5.5	3.8	24
SC-10	f6, f8	6.8	4.8	25.5
SC-16	f6, f8, f10	7.5	5.5	30.5
SC-25	f6, f8, f10, f12	9	7	34
SC-35	f8, f10, f12	10.5	8.2	38
SC-50	f8, f10, f12	12.5	9.8	45
SC-70	f8, f10, f12	14.5	11.5	50
SC-95	f10, f12	17.5	13.8	55.5
SC-120	f12, f16	19.5	15.5	63
SC-150	f12, f16	20.5	16.5	70
SC-185	f16	23.5	18.8	78
SC-240	f16	26	21	92
SC-300	f16, f20	30	24	102
SC-400	f16, f20	34	27	113
SC-500	f16, f20	38	30	123
SC-630	f20	45	35	135
SC-800	f22	50	40	170
SC-1000	f22	56	44	200

A Wintersweet Shaped Red Copper Jointing Clamp

1. Application

It is suitable for transition connection of the electric appliances of indoors distributing device and kinds of wire cables. It adopts T2 red copper, the surface nickle plating.

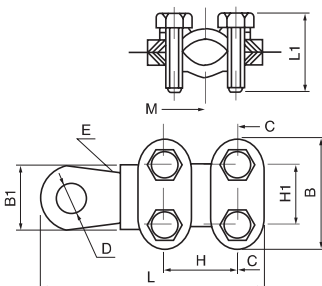

2. Specification

Type	L	L1	B	B1	H	H1	D	M
A16-25-1	39.5	15	25	16.5	13	13	8.5	5
A16-25-2	45	15	22	18	13	13	8.5	5
A25-35	52.5	15	24.5	21.2	13.5	13.5	10.5	5
A50-70	61	21	31	23	18.5	18.5	10.5	6
A70-95	69	24	35	23.5	20	20	10.5	6
A95-120	74	20.5	42	28.5	22.5	22.5	13.5	7
A120-150	73.5	30	41	27	24	24	13.5	8
A150-185	76	30	42	28	24.5	24.5	13.5	8
A185-240	80	32	44	30	25	25	13.5	8

B Wintersweet Shaped Copper Jointing Clamp

1. Application

It is suitable for transition connection of electronic apparatus with wire and cable in indoor distribution equipment, made of brass by die cast and coated nickle.

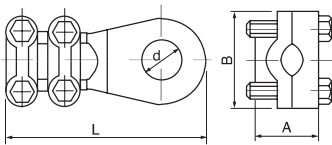

2. Specification

Type	L	A	B	d
B16-25	37	10	21	7.5
B25-35	48	13	22	11
B50-70	60	17	31	11
B120-150	70	23	35	15
B210-250	90	30	46	17

GTY Copper Cable Connector

1. Application

GTY series copper cable connectors are applicable for the connection of the circular wire with power supply cable in distribution equipment. They are made of tin coated 99.9% pure copper tube.

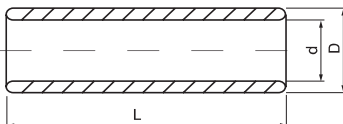

2. Specification

Type	D (mm)	d (mm)	L (mm)
GTY-1.5	3.7	1.8	20
GTY-2.5	4	2.5	20
GTY-4	4.8	3.1	20
GTY-5.5	5.5	3.8	25
GTY-10	6.8	4.8	30
GTY-16	7.5	5.5	35
GTY-25	9	7	40
GTY-35	10.5	8.2	45
GTY-50	12.5	9.8	50
GTY-70	14.5	11.5	55
GTY-95	17.5	13.5	60
GTY-120	19.5	15	65
GTY-150	21	16.5	70
GTY-185	23.5	18.5	75
GTY-240	26.5	21	80
GTY-300	30	24	85
GTY-400	34	27	90
GTY-500	38	30	100
GTY-630	45	35	110
GTY-800	50	39	150
GTY-1000	56	44	170

DTL Copper-aluminium Cable Lug

1. Application

DTL series of copper-aluminum cable lug are suitable for transition connection of the circular aluminium wires, hemicyce-sector aluminium wires, power supply cables in the distribution equipment and copper terminals of the electrical equipment. The material of aluminium and copper is that of L3 and T2 respectively. The technology of friction welding is wonderfully adopted. Therefore they have distinguishing features of strong weld intensity, good nature in electrification, resistant galvanic corrosion and long service life.

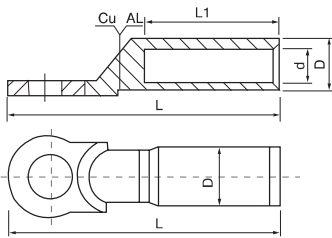

2. Specification

Type	ø (mm)	D (mm)	d (mm)	L (mm)	L1 (mm)
DTL-2-16	13	16	5.5	87	42
DTL-2-25	13	16	6.5	87	42
DTL-2-35	13	16	8	87	42
DTL-2-50	13	20	9	87	43
DTL-2-70	13	20	11	87	43
DTL-2-95	13	20	12.5	87	43
DTL-2-120	13	25	13.5	111	60
DTL-2-150	13	25	15.5	111	60
DTL-2-185	13	32	17.5	116	60
DTL-2-240	13	32	19.5	116	60
DTL-2-300	13	34	22.5	120	62

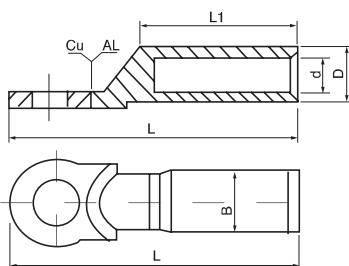

Type	ø (mm)	D (mm)	d (mm)	L (mm)	L1 (mm)	B (mm)
DTL-1-10	8.5	10	6	68	28	16
DTL-1-16	8.5	11	6	70	30	16
DTL-1-25	8.5	12	7	75	34	18
DTL-1-35	10.5	14	8.5	85	38	20.5
DTL-1-50	10.5	16	9.8	90	40	23
DTL-1-70	12.5	18	11.5	102	48	26
DTL-1-95	12.5	21	13.5	112	50	28
DTL-1-120	14.5	23	15	120	53	30
DTL-1-150	14.5	25	16.5	126	56	34
DTL-1-185	16.5	27	18.5	133	58	37
DTL-1-240	16.5	30	21	140	60	40
DTL-1-300	21	34	23.5	160	65	50
DTL-1-400	21	38	27	170	70	50
DTL-1-500	21	47	29	225	75	60
DTL-1-630	—	54	35	245	80	80
DTL-1-800	—	60	38	270	90	100

Spade Shaped Insulated Terminal

1. Specification



Lead section: 0.5~1.5mm²(22~16) Max current: =19A

Item.No.	Number of ANSI bolt	Diameter of bolt mouth d2	B (mm)	L (mm)	F (mm)	H (mm)	DØ (mm)	Color
SV1.25-3	#4	3.2mm	5.7	21.2	6.5	10.0	4.3	Red
SV1.25-4	#8	4.3mm	6.4	21.2	6.5			
SV1.25-5	#10	5.3mm	8.1	21.2	6.5			
SV1.25-6	1/4	6.5mm	9.5	21.2	6.5			
SV1.25-6	1/4	6.5mm	12.0	21.2	11.0			

Lead section: 1.5~2.5mm²(16~14) Max current: =27A

Item.No.	Number of ANSI bolt	Diameter of bolt mouth d2	B (mm)	L (mm)	F (mm)	H (mm)	DØ (mm)	Color
SV2-3	#4	3.2mm	5.7	21.2	6.5	10.0	4.9	Blue
SV2-4	#8	4.3mm	6.4	21.2	6.5			
SV2-5	#10	5.3mm	8.1	21.2	6.5			
SV2-6	1/4	6.5mm	9.5	21.2	6.5			

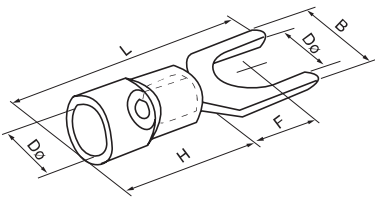

Lead section: 2.5~4mm²(14~12) Max current: =37A

Item.No.	Number of ANSI bolt	Diameter of bolt mouth d2	B (mm)	L (mm)	F (mm)	H (mm)	DØ (mm)	Color
SV3.5-4	#8	4.3mm	8.0	24.8	7.0	12.5	6.2	Black
SV3.5-5	#10	5.3mm	8.0	24.8	7.0			
SV3.5-6	1/4	6.5mm	12.0	28.0	12.1			

Lead section: 4~6mm²(12~10) Max current: =48A

Item.No.	Number of ANSI bolt	Diameter of bolt mouth d2	B (mm)	L (mm)	F (mm)	H (mm)	DØ (mm)	Color
SV5.5-4	#8	4.3mm	8.3	25.2	7.5	12.5	6.7	Yellow
SV5.5-5	#10	5.3mm	9.0	23.9	7.5			
SV5.5-6	1/4	6.5mm	9.0	23.9	7.5			
SV5.5-8	5/16	8.4mm	14.0	30.0	11.5			

Ring Shaped Insulated Terminal

1. Specification

Lead section: 0.5~1.5mm²(22~16) Max current: =19A

Item.No.	Number of ANSI bolt	Diameter of bolt mouth d2	B (mm)	L (mm)	F (mm)	H (mm)	DØ (mm)	Color
RV1.25-3	#4	3.2mm	5.7	17.8	4.95	10.0	4.3	Red
RV1.25-3.5	#6	3.7mm	5.7	17.8	4.95			
RV1.25-3.5	#6	3.7mm	6.6	20.1	6.3			
RV1.25-3.5	#6	3.7mm	8.0	21.5	7.0			
RV1.25-4	#8	4.3mm	6.6	20.1	6.3			
RV1.25-4	#8	4.3mm	8.0	21.5	7.0			
RV1.25-5	#10	5.3mm	8.0	21.5	7.0			
RV1.25-6	1/4	6.5mm	11.6	27.5	11.1			
RV1.25-8	5/16	8.4mm	11.6	27.5	11.1			
RV1.25-10	3/8	10.5mm	13.6	31.6	13.9			

Lead section: 1.5~2.5mm²(16~14) Max current: =27A

Item.No.	Number of ANSI bolt	Diameter of bolt mouth d2	B (mm)	L (mm)	F (mm)	H (mm)	DØ (mm)	Color
RV2-3	#4	3.2mm	6.6	17.8	4.3	10.0	4.9	Blue
RV2-3.5	#6	3.7mm	6.6	17.8	4.3			
RV2-3.5	#6	3.7mm	6.6	21.0	7.0			
RV2-3.5	#6	3.7mm	8.5	22.5	7.75			
RV2-4	#8	4.3mm	6.6	21.0	7.0			
RV2-4	#8	4.3mm	8.5	22.5	7.75			
RV2-5	#10	5.3mm	8.5	22.5	7.75			
RV2-5	#10	5.3mm	9.5	22.5	7.25			
RV2-6	1/4	6.5mm	12.0	27.6	11.0			
RV2-8	5/16	8.4mm	12.0	27.6	11.0			
RV2-10	3/8	10.5mm	13.6	30.2	13.9			

Lead section: 2.5~4mm²(14~12) Max current: =37A

Item.No.	Number of ANSI bolt	Diameter of bolt mouth d2	B (mm)	L (mm)	F (mm)	H (mm)	DØ (mm)	Color
RV3.5-4	#8	4.3mm	8.0	24.5	7.7	12.5	6.2	Black
RVS3.5-5	#10	5.3mm	8.0	24.6	7.7			
RVL3.5-5	#10	5.3mm	12.0	27.9	7.7			
RV3.5-6	1/4	6.5mm	12.0	27.9	7.7			

Lead section: 4~6mm²(12~10) Max current: =48A

Item.No.	Number of ANSI bolt	Diameter of bolt mouth d2	B (mm)	L (mm)	F (mm)	H (mm)	DØ (mm)	Color
RV5.5-3.5	#6	3.7mm	7.2	21.4	5.9	12.5	6.7	Yellow
RV5.5-4	#8	4.3mm	7.2	21.5	5.9			
RV5.5-4	#8	4.3mm	9.5	25.5	8.3			
RV5.5-5	#10	5.3mm	9.5	25.5	8.3			
RV5.5-6	1/4	6.5mm	12.0	31.5	13.0			
RV5.5-8	5/16	8.4mm	15.0	33.7	13.7			
RV5.5-10	3/8	10.5mm	15.0	33.7	13.7			
RV5.5-12	1/2	13.0mm	19.2	38.1	16.0			



Pin Shaped Insulated Terminal

1. Specification

Lead section: 0.5~1.5mm²(22~16) Max current: =19A

Item.No.	FØ (mm)	Dimension (mm)			Color
		L	H	DØ	
PTV1.25-9	1.9	19.0	10.0	4.3	Red
PTV1.25-10	1.9	20.0			
PTV1.25-12	1.9	22.0			
PTV1.25-13	1.9	23.0			

Lead section: 1.5~2.5mm²(16~14) Max current: =27A

Item.No.	FØ (mm)	Dimension (mm)			Color
		L	H	DØ	
PTV2-9	1.9	19.0	10.0	4.9	Blue
PTV2-10	1.9	20.0			
PTV2-12	1.9	22.0			
PTV2-13	1.9	23.0			

Lead section: 4~6mm²(12~10) Max current: =48A

Item.No.	FØ (mm)	Dimension (mm)			Color
		L	H	DØ	
PTV5.5-13	2.8	25.5	12.5	6.7	Yellow

Lead section: 0.5~1.5mm²(22~16) Max current: =19A

Item.No.	Dimension (mm)			C
	W	L	F	
DBV1.25-10	2.3	20.0	10.0	4.3
DBV1.25-11	3.0	21.0	11.0	
DBV1.25-14	3.0	24.0	14.0	
DBV1.25-18	2.3	28.0	18.0	

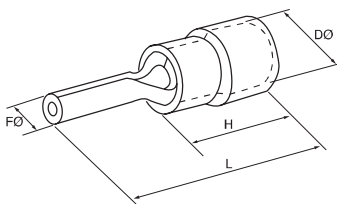

Lead section: 1.5~2.5mm²(16~14) Max current: =27A

Item.No.	Dimension (mm)			C
	W	L	F	
DBV2-9	2.8	19.0	9.0	4.9
DBV2-18	2.3	28.0	18.0	

Lead section: 4~6mm²(12~10) Max current: =48A

Item.No.	Dimension (mm)			C
	W	L	F	
DBV5.5-10	2.8	22.5	10.0	5.6

Butt Shaped Insulated Terminal

1. Specification



Item.No.	AWG	mm ²	Dimension (mm)			Max	Color
			I	DØ	L		
BV1.25	22~16	0.5~1.5	15.0	1.7	26.0	19A	Red
BV2	16~14	1.5~2.5	15.0	2.3	26.0	27A	Blue
BV5.5	12~10	4~6	15.0	3.4	26.0	48A	Yellow
BV8	#8	6~10	21.0	4.5	32.0	62A	Red
BV14	#6	10~16	26.0	5.8	42.0	88A	Blue
BV22	#4	16~25	29.0	7.7	50.0	115A	Yellow
BV38	#2	35~50	32.0	9.4	55.0	160A	Red

Item.No.	AWG	mm ²	Dimension (mm)			Max	Color
			I	DØ	L		
PVT1.25	22~16	0.5~1.5	8.0	1.7	16.0	19A	Red
PVT2	16~14	1.5~2.5	8.0	2.3	16.0	27A	Blue
PVT5.5	12~10	4~6	8.5	3.4	20.5	48A	Yellow

Item.No.	Dimension (mm)			Wire Range		
	I	DØ	dØ	Single (mm)	Twin (mm ²)	A.W.G
B-1.25	16.5	3.3	1.9	0.57~1.44	0.25~1.65	22~16
B-2	16.5	4.0	2.6	1.44~1.82	1.04~2.63	16~14
B-5.5	16.5	5.5	3.7	1.82~2.89	2.63~6.64	12~10
B-8	22.5	7.1	5.1	2.89~3.56	6.64~10.52	8
B-14	27.5	9.0	6.4	3.56~4.62	10.52~16.78	6
B-22	30.5	11.4	8.2	4.62~5.81	16.78~26.66	4
B-38	33.5	13.3	10.1	5.81~7.34	26.66~42.42	2
B-60	36.0	15.4	12.0	7.34~8.26	42.42~60.57	1/0
B-70	37.8	17.4	14.0	8.26~9.27	60.57~76.28	2/0
B-80	39.5	19.4	15.4	9.27~10.41	76.28~96.3	3/2
B-100	39.5	22.0	17.6	10.41~11.68	96.6~117.2	4/0
B-125	43.4	24.1	19.2	10.01~12.7	107.2~130.4	4/0
B-150	55.5	26.0	20.9	11.68~13.8	117~152.05	250~300MCM
B-180	58.5	28.6	22.0	13.8~15.6	152.05~192.6	300~350MCM
B-200	64.5	32.5	25.7	15.6~17.5	192.6~242.2	400MCM
B-250	64.5	32.5	25.7	15.6~17.5	192.6~242.2	400MCM
B-325	73.5	37.0	29.0	17.5~20.3	242.2~325	500~600MCM

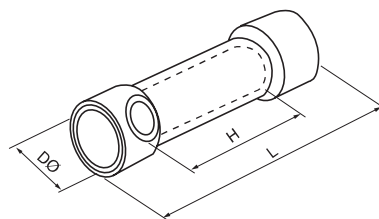

Butt Insulated Terminal

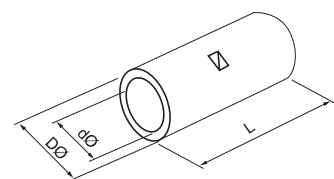

Butt Terminal

Male Insulated Disconnecter

1. Specification

Lead section: 0.5~1.5mm²(22~16) Max current: =10A



Item.No.	Meme Tab (mm)	Thickness (mm)	Dimension (mm)				
			B	dØ	DØ	L	H
MDD1.25-11(8)	0.8 x 2.8	0.8	2.8	1.70	4.3	17.7	10
MDD1.25-187(5)	0.5 x 4.75	0.5	4.75	1.70	4.3	20.0	10
MDD1.25-187(8)	0.8 x 4.75	0.8	4.75	1.70	4.3	18.5	10
MDD1.25-250	0.8 x 6.35	0.4	6.35	1.70	4.3	21.0	10

Lead section: 1.5~2.5mm²(16~14) Max current: =15A

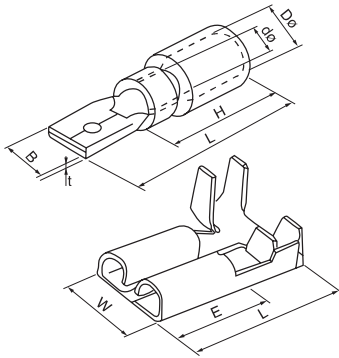

Item.No.	Meme Tab (mm)	Thickness (mm)	Dimension (mm)				
			B	dØ	DØ	L	H
MDD2-187(5)	0.5 x 4.75	0.5	4.75	2.3	4.3	20.0	10
MDD2-187(8)	0.8 x 4.75	0.8	4.75	2.3	4.3	18.5	10
MDD2-250	0.8 x 6.35	0.4	6.35	2.3	4.3	21.0	10

Lead section: 4~6mm²(12~10) Max current: =24A

Item.No.	Meme Tab (mm)	Thickness (mm)	Dimension (mm)				
			B	dØ	DØ	L	H
MDD5.5-250	0.8 x 6.35	0.4	6.35	3.4	5.7	25.0	14.0

Male and Female Full-Insulated Terminal

• Max. Current: 10A • Metal: Brass • Insulated Material: Nylon



Item.No.	Specifica- tion	Dimension(mm)							Fig	A.W.G mm ²	Color
		W	F	L	B	DØ	CØ	T			
FDFN 1.25-250	0.8 x 6.35	6.6	7.3	22.0	11.0	4.0	1.7	0.4	1	22-16A.W.G	Red
MDFN 1.25-250		6.35	7.7	23.0					2	0.5-1.5mm ²	

• Max. Current: 15A • Metal: Brass • Insulated Material: Nylon

Item.No.	Specifica- tion	Dimension(mm)							Fig	A.W.G mm ²	Color
		W	F	L	B	DØ	CØ	T			
FDFN 2-250	0.8 x 6.35	6.6	7.3	22.0	11.0	4.0	2.3	0.4	1	16-14A.W.G	Blue
MDFN 2-250		6.35	7.7	24.0					2	1.5-2.5mm ²	

• Max. Current: 24A • Metal: Brass • Insulated Material: Nylon

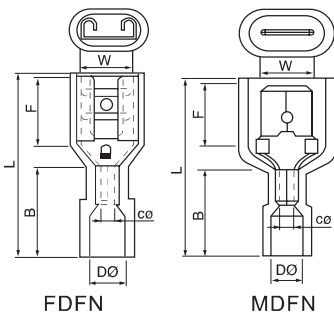

Item.No.	Specifica- tion	Dimension(mm)							Fig	A.W.G mm ²	Color
		W	F	L	B	DØ	CØ	T			
FDFN 5.5-250	0.8 x 6.35	6.6	7.3	22.0	13.0	6.3	3.4	0.4	1	12-10A.W.G	Yellow
MDFN 5.5-250		6.35	7.7	25.0					2	4-6mm ²	

Female Insulated Disconnecter

1. Specification

Lead section: 0.5~1.5mm²(22~16) Max current: =10A



Item.No.	Meme Tab (mm)	Thickness (mm)	Dimension (mm)				
			B	dØ	DØ	L	H
FDD1.25-110(5)	0.5 x 2.8	0.3	3.8	1.70	3.80	19.0	19.0
FDD1.25-110(8)	0.8 x 2.8	0.3	3.8	1.70	3.80	19.0	19.0
FDD1.25-187(5)	0.5 x 4.75	0.35	5.6	1.70	3.80	19.0	19.0
FDD1.25-187(8)	0.8 x 4.75	0.35	5.6	1.70	3.80	19.0	19.0
FDD1.25-250	0.8 x 6.35	0.4	7.4	1.70	3.80	21.0	21.0

Lead section: 1.5~2.5mm²(16~14) Max current: =15A

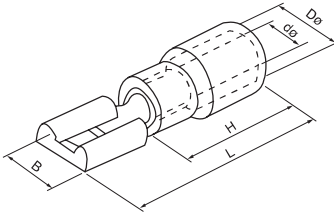

Item.No.	Meme Tab (mm)	Thickness (mm)	Dimension (mm)				
			B	dØ	DØ	L	H
FDD2-110(5)	0.5 x 0.8	0.3	3.8	2.3	4.3	19.0	10
FDD2-110(8)	0.8 x 2.8	0.3	3.8	2.3	4.3	19.0	10
FDD2-187(5)	0.5 x 4.75	0.35	5.6	2.3	4.3	19.0	10
FDD2-187(8)	0.8 x 4.75	0.35	5.6	2.3	4.3	19.0	10
FDD2-250	0.8 x 6.35	0.4	7.4	2.3	4.3	21.0	10
FDD2-312	0.8 x 0.8	0.4	9.0	2.3	4.3	23.0	10

Lead section: 4-6mm²(12-10) Max current: 24A

Item.No.	Meme Tab (mm)	Thickness (mm)	Dimension (mm)				
			B	dØ	DØ	L	H
FDD5.5-250	0.5 x 3.65	0.4	7.4	3.4	5.7	25.0	14.0
FDD5.5-375	1.2 x 9.4	0.5	10.9	3.4	5.7	25.0	14.0

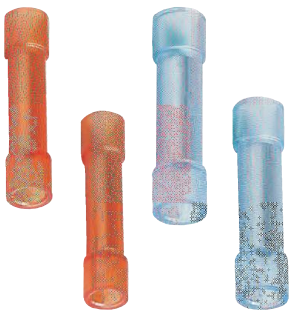

Long Full Insulated Middle Terminal

- Max. Current: 26-22A.W.G: 9A 22-16A.W.G: 19A
16-14A.W.G: 27A 12-10A.W.G: 48A
- Max. Endure Voltage: 105°C U_i=600V
- Insulated Material: Nylon

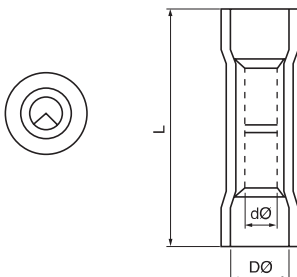

Item.No.	Dimension(mm)			A.W.G mm ²	Color
	L	DØ	CØ		
BNY-1.25	27.3	3.2	1.7	22-16 A.W.G 0.5-1.5mm ²	Red
BNY-2	27.3	3.8	2.3	16-14 A.W.G 1.5-2.5mm ²	Blue
BNY-5.5	27.3	5.3	3.4	12-10 A.W.G 4-6mm ²	Yellow

Bullet & Receptacle Insulated Disconnecter

1. Specification

Lead section: 0.5~1.5mm²(22~16) Max current: =10A

Item.No.	Thickness (mm)	Dimension (mm)						Color
		bØ	F	DØ	dØ	H	L	
MPD1.25-156	0.4	4.0	11.0	2.7	1.7	10.0	21.0	Red

Lead section: 1.5~2.5mm²(16~14) Max current: =15A

Item.No.	Thickness (mm)	Dimension (mm)						Color
		bØ	F	DØ	dØ	H	L	
MPD2-156	0.4	4.0	16.0	2.7	1.7	10.0	21.0	Blue
MPD2-195	0.4	5.0	16.0	2.7	1.7	10.0	21.0	

Lead section: 4~6mm²(12~10) Max current: =24A

Item.No.	Thickness (mm)	Dimension (mm)						Color
		bØ	F	DØ	dØ	H	L	
MPD5.5-195	0.4	4.0	11.0	4.5	3.4	14.0	25.0	Yellow

Lead section: 0.5~1.5mm²(22~16) Max current: =10A

Item.No.	Thickness (mm)	Dimension (mm)						Color
		bØ	F	DØ	dØ	H	L	
FRD1.25-156	0.4	4.0	16.0	2.7	1.7	13.0	24.5	Red

Lead section: 1.5~2.5mm²(16~14) Max current: =15A

Item.No.	Thickness (mm)	Dimension (mm)						Color
		bØ	F	DØ	dØ	H	L	
FRD2-156	0.4	4.0	6.3	3.3	2.3	14.0	24.5	Blue
FRD2-195	0.4	5.0	7.0	3.3	2.3	14.0	24.5	

Lead section: 4~6mm²(12~10) Max current: =24A

Item.No.	Thickness (mm)	Dimension (mm)						Color
		bØ	F	DØ	dØ	H	L	
FRD5.5-195	0.4	5.0	7.0	4.5	3.4	14.0	29.5	Yellow

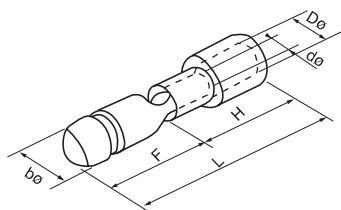

MALE

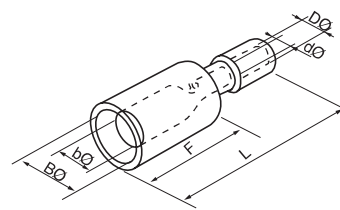

FEMALE

Fully Vinyl Insulated Disconnecter

1. Specification

Lead section: 0.5~1.5mm²(22~16) Max current: =10A

Item.No.	Meme Tab (mm)	Dimension (mm)				
		W	B	DØ	dØ	L
FDFD1.25-187(5)	0.5 x 4.75	5.6	3.28	4.0	1.7	20.0
FDFD1.25-187(8)	0.8 x 4.75	5.6	3.28	4.0	1.7	20.0
FDFD1.25-250	0.8 x 6.35	7.4	3.28	4.0	1.7	21.5

Lead section: 1.5~2.5mm²(16~14) Max current: =15A

Item.No.	Meme Tab (mm)	Dimension (mm)				
		W	B	DØ	dØ	L
FDFD2-187(5)	0.5 x 4.75	5.6	5.0	4.5	2.3	20.0
FDFD2-187(8)	0.8 x 4.75	5.6	5.0	4.5	2.3	20.0
FDFD2-250	0.8 x 6.35	7.4	5.0	4.5	2.3	21.5

Lead section: 4~6mm²(12~10) Max current: =24A

Item.No.	Meme Tab (mm)	Dimension (mm)				
		W	B	DØ	dØ	L
FDFD5.5-250	0.8 x 6.35	7.4	6.6	5.7	3.4	25.5

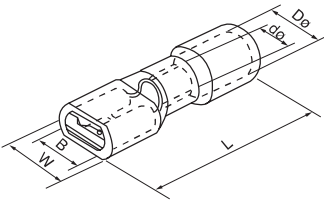

Piggy Back Disconnecter

1. Specification

Lead section: 0.5~1.5mm²(22~16) Max current: =10A

Item.No.	Meme Tab (mm)	Dimension (mm)					
		B	B1	B	DØ	dØ	L
PBDD1.25-250	0.8 x 6.35	7.4	6.3	10.0	3.8	1.7	21.5

Lead section: 1.5~2.5mm²(16~14) Max current: =15A

Item.No.	Meme Tab (mm)	Dimension (mm)					
		B	B1	B	DØ	dØ	L
PBDD2-250	0.8 x 6.35	7.4	6.3	10.0	4.3	2.3	21.5

Lead section: 4~6mm²(12~10) Max current: =24A

Item.No.	Meme Tab (mm)	Dimension (mm)					
		B	B1	B	DØ	dØ	L
PBDD5.5-250	0.8 x 6.35	7.4	6.3	14.0	5.7	3.4	25.0

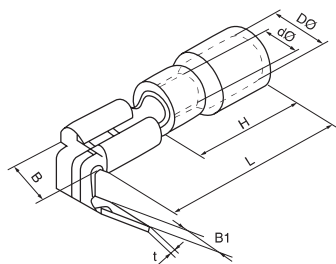

Insulated Ring Shaped Terminal

1. Specification

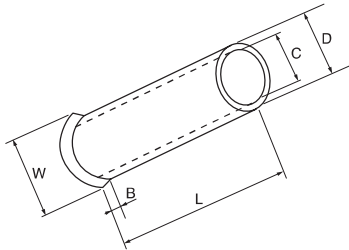

Item.No.	Dimension (mm)					A.W.G	mm ²
	L	D	C	B	W		
EN0506	6.0	1.3	1.0	0.7	2.1	#22	0.5
EN75.6	6.0	1.5	1.2	0.7	2.5	#20	0.75
EN1006	6.0	1.7	1.4	0.7	2.7	#18	1.0
EN1010	10.0						
EN1507	7.0	2.0	1.7	1.0	3.5	#16	1.5
EN1510	10.0						
EN2507	7.0	2.5	2.2	1.0	2.5	#14	2.5
EN2512	12.0						
EN4009	9.0	3.2	2.8	1.0	4.0	#12	4.0
EN4012	12.0						
EN6010	10.0	3.9	3.5	1.0	4.8	#10	6.0
EN6012	12.0						
EN6015	15.0						
EN10-12	12.0	4.9	4.5	1.2	5.8	#7	10.0
EN10-15	15.0						
EN10-18	18.0						
EN16-12	12.0	6.2	5.8	1.5	7.5	#5	16.0
EN16-15	15.0						
EN16-18	18.0						
EN25-16	16.0	7.9	7.5	1.8	9.2	4	25
EN25-22	22.0						
EN35-16	16.0	8.7	8.3	2.0	10	2	35
EN35-25	25.0						
EN50-20	20.0	10.9	1.3	2.0	12.4	1	50
EN50-25	25.0						

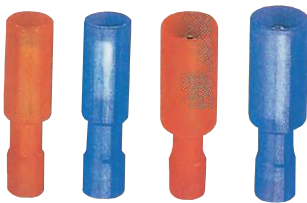

Bullet Shaped Male and Female Full-Insulated Terminal

• Max. Current: 22-16A.W.G: 19A 16-14A.W.G: 27A

• Metal: Brass • Insulated Material: Nylon

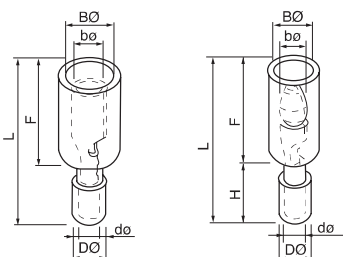

Item.No.	Dimension(mm)							Fig	A.W.G mm ²	Color
	BØ	bØ	DØ	dØ	L	F	H			
DFDNY 1.25-156	6.9	6.9	3.2	1.8	26.0	15.0	11.0	1	22-16A.W.G 0.5-1.5mm ²	Red
MPFDNY 1.25-156	7.4	3.9	3.2	1.8	27.5	16.5	11.0	2	22-16A.W.G 0.5-1.5mm ²	Red
DFDNY 2-156	6.9	4.0	3.9	2.4	26.0	15.5	11.0	1	16-14A.W.G 1.5-2.5mm ²	Blue
MPFDNY 2-156	7.4	4.0	3.9	2.4	27.5	16.5	11.0	2	16-14A.W.G 1.5-2.5mm ²	Blue

Cord Insulated End Terminal

1. Specification



Item.No.	Dimension (mm)						A.W.G	mm ²	Insulation Color
	F	L	W	B	D	C			
E0506	6.0	12.0	2.6	6.0	1.3	1.0	#22	0.5	Orange White
E0508	8.0	14.0							
E0510	10.0	16.0							
E7506	6.0	12.4	2.8	6.4	1.5	1.2	#20	0.75	White Blue
E7508	8.0	14.6							
E7510	10.0	16.4							
E7512	12.0	18.4							
E1008	8.0	14.6	3.0	6.4	1.7	1.4	#18	1.0	Yellow Red
E1010	10.0	16.4							
E1012	12.0	18.4							
E1508	8.0	14.6	3.5	6.4	2.0	1.7	#16	1.5	Red Black
E1510	10.0	16.4							
E1518	18.0	24.4							
E2508	8.0	15.2	4.0	7.5	2.6	2.3	#14	2.5	Blue Grey
E2512	12.0	19.0							
E2518	18.0	25.0							
E4009	9.0	16.5	4.4	7.5	3.2	2.8	#12	4.0	Grey Orange
E4012	12.0	19.5							
E4018	18.0	25.5							
E6012	12.0	20.0	6.3	8.0	3.9	3.5	#10	6.3	Black Green
E6018	18.0	26.0							
E10-12	12.0	24.5	7.6	9.5	4.9	4.5	#7	10.0	Milky White Brown Green
E10-18	18.0	27.5							
E16-12	12.0	22.0	8.8	10.2	6.2	5.8	#5	16.0	Green Milky White
E16-18	18.0	28.2							
E25-16	18.0	29.0	11.2	13.0	7.9	7.5	#4	25.0	Brown Green Black
E25-22	22.0	35.0							
E35-16	16.0	30.0	12.7	14.0	8.7	8.3	#2	35.0	Greyish Brown
E35-25	25.0	39.0							
E50-20	20.0	36.0	15.3	16.0	10.9	10.3	#1	50.0	Olive
E50-25	25.0	41.0							

Cable Clamp

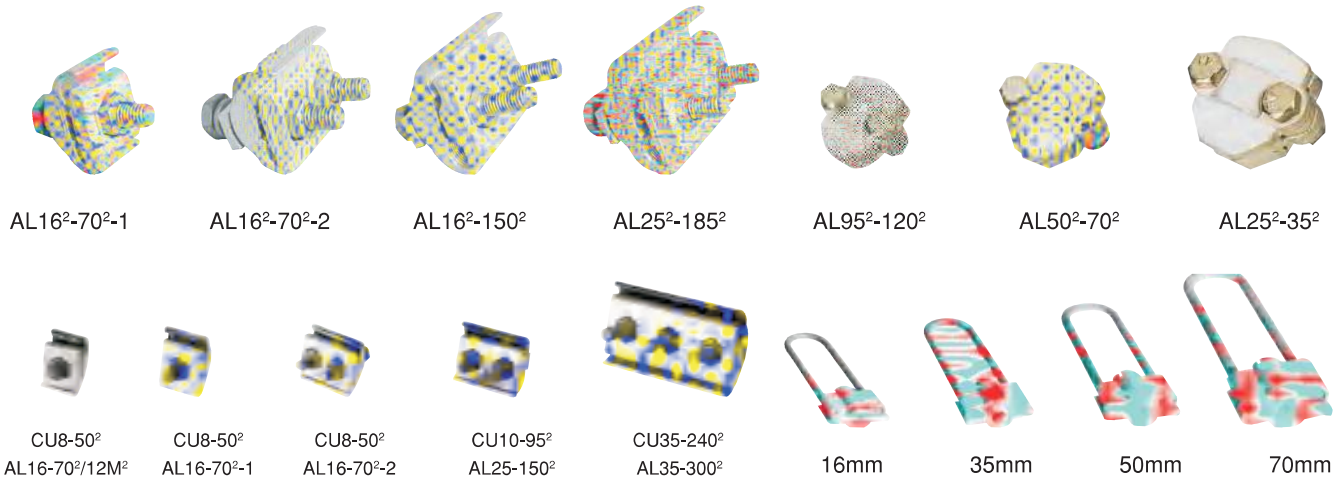

TB TC Terminal Connector

1. Specification

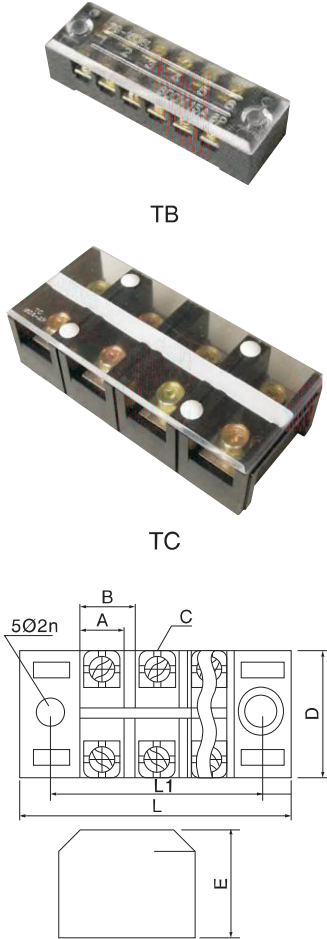

Type	Current	No. of poles	Dimension (mm)								
			L	L1	A	B	C	D	E	F	G
TB-1503	15A	3	46	36.5	7.5	9	M3	22	17		
TB-1504		4	55	45.5	7.5	9	M3	22	17		
TB-1506		6	73	63.5	7.5	9	M3	22	17		
TB-1512		12	127	118	7.5	9	M3	22	17		
TB-2503	25A	3	50	40	10.5	12	M4	30	20		
TB-2504		4	62.5	57	10.5	12	M4	30	320		
TB-2506		6	91	81.5	10.5	12	M4	30	20		
TB-2512		12	163	153	10.5	12	M4	30	20		
TB-3503	35A	3	50	40	10.5	12	M4	30	20		
TB-3504		4	62.5	57	10.5	12	M4	30	20		
TB-3506		6	91	81.5	10.5	12	M4	30	20		
TB-3512		12	163	153	10.5	12	M4	30	20		
TB-4503	45A	3	70	60.5	15	17	M5	38	23.5		
TB-4504		4	86	75.5	15	17	M5	38	23.5		
TB-4506		6	120.5	110	15	17	M5	38	23.5		
TB-4512		12	224	212	15	17	M5	38	23.5		
TB-603	60A	3	70.5	65.5	15.5	18	M6	38	31		
TB-604		4	93.5	82.5	15.5	18	M6	38	31		
TB-606		6	129	118	15.5	18	M6	38	31		
TB-1003	100A	3	86.5	75.5	22	20	M6	43.5	35		
TB-1004		4	108	96	22	20	M6	43.5	35		
TB-1006		6	153	140	22	20	M6	43.5	35		
TC-603	60A	3	28.5	86.5	38	42.7	25.5	31	15	17	M6
TC-604		4	28.5	115	38	42.7	25.5	31	15	17	M6
TC-1003	100A	3	34.5	113.5	46.5	55.2	28	36.3	17.3	22.5	M6
TC-1004		4	34.5	137.5	46.5	55.2	28	36	17.3	22.5	M6
TC-1503	150A	3	38.5	115	57.2	67	30.5	340	19.8	25.3	M8
TC-1504		4	38.5	153	57.2	67	30.5	40	19.8	25.3	M8
TC-2003	200A	3	44.5	133	63	72.1	34	44.4	23	28.3	M8
TC-2004		4	44.5	177	63	72.1	34	44.4	23	28.3	M8
TC-3003	300A	3	55	164	78	89.4	47.5	50.6	27	30	M10
TC-3004		4	55	218	78	89.4	47.5	50.6	27	30	M10
TC-4003	400A	3	55	164	78	89.4	47.5	50.6	27	36	M10
TC-4004		4	55	218	78	89.4	47.5	50.6	27	36	M10

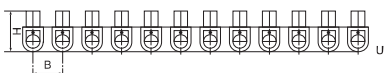
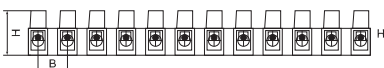
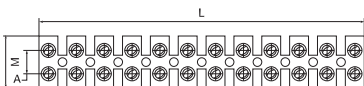

Terminal Blocks

TERMINAL BLOCKS H, U(W), V(F) TYPE

Material: made of PA, PE or PP.

Item.No.	mm ²	L	W	H	A	B	VOLT	Packing
TBS-3A	4	93	16	12	6	8	400V	10PCS
TBS-6A	6	115	15.7	13	6.5	9.5	400V	
TBS-10A	10	126	20.2	15.5	8.4	10.5	400V	
TBS-16A	12	139	23	17.7	10.3	12	400V	
TBS-20A	14	155	25	19.2	11.5	13.5	400V	
TBS-30A	16	171	26	20.5	12	14.5	400V	
TBS-60A	25	192	30	26	13.5	16.5	400V	
TBS-80A	35	205	33	27	15	17	400V	
TBS-100A	40	250	46	31	22	21	400V	

SM Insulating Connector



Values	Style					
	SM-25	SM-30	SM-35	SM-40	SM-51	SM-76
Tensile strength (lbs)	500	550	600	650	1000	1500
Tongue strength (ft lbs)	6	8	10	10	20	40
Voltage withstand (kV)	6	8	10	12	15	25
Screw (mm)	6	8	8	8	8	10
Weight (g)	28	44	50	86	83	233

SM

UK Terminal Block

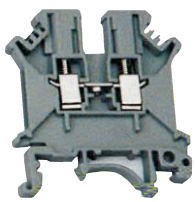

UK 2.5N



UK 3N

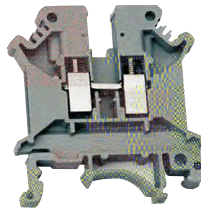

UK 5N

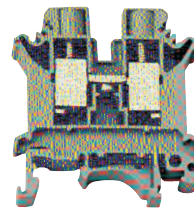

UK 10N

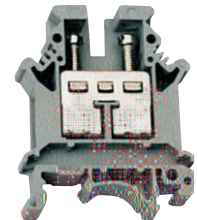

UK 16N



USLKG 2.5/35

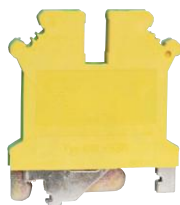

USLKG 3/35



USLKG 10/35



USLKG 16/35



USLKG 35/35

Model	Hard Wire (mm ²)	Soft Wire (mm ²)	Rated Current (A)	Rated Voltage (V)	Dimension (mm)
UK2.5B	0.2-4	0.2-2.5	32	690	6.2 x 42.5 x 42
UK3N	0.2-4	0.2-2.5	32	800	6.2 x 42.5 x 42
UK5N	0.2-6	0.2-4	41	800	6.2 x 42.5 x 47
UK6N	0.2-10	0.2-2.5	57	800	6.2 x 42.5 x 47
UK10N	0.5-16	0.5-10	76	800	10.2 x 42.5 x 47
UK16N	2.5-25	4-16	101	800	12.2 x 42.5 x 54
UK35N	0.75-50	0.75-35	150	1000	15.2 x 50.0 x 62
UKH50	16-50	25-50	150	1000	20 x 70.5 x 83.5
UKH95	25-95	35-95	232	1000	25 x 83 x 97.5
UKH150	35-150	50-150	309	1000	31 x 100 x 118.5

Model	Hard Wire (mm ²)	Soft Wire (mm ²)	Rated Current (A)	Dimensions (mm)
USLKG2.5	0.2-4	0.2-2.5	32	6.2 x 42.5 x 42
USLKG3	0.2-4	0.2-2.5	32	6.2 x 42.5 x 47
USLKG5	0.2-6	0.2-4	41	6.2 x 42.5 x 47
USLKG6N	0.2-10	0.2-6	57	8.2 x 42.5 x 47
USLKG10N	0.5-16	0.5-10	76	10.2 x 42.5 x 47
USLKG16N	2.525	4-16	101	12.2 x 42.5 x 54
USLKG35N	0.75-50	0.75-35	150	15.2 x 50.0 x 62
USLKG50	16-50	25-50	150	20 x 70.5 x 81.5

Terminal Block

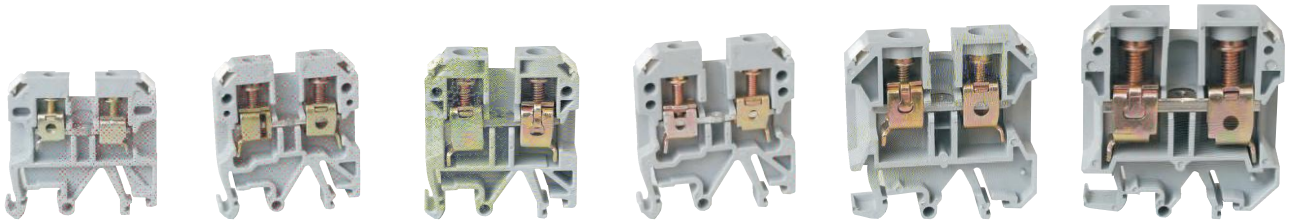

JXB 2.5/35

JXB 4/35

JXB 6/35

JXB 10/35

JXB 16/35

JXB 35/35

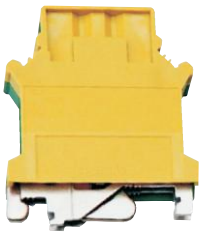

JB 2.5/35



JB 4/35

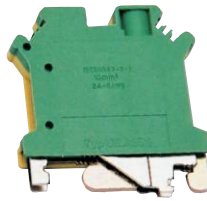

JB 6/35

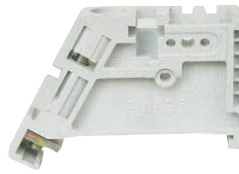

End Stopper



Separator

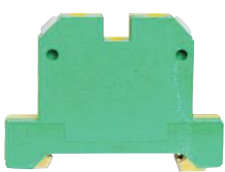

EK 4/35

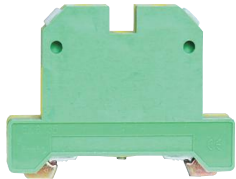

EK 6/35

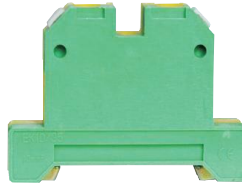

EK 10/35



EK 16/35

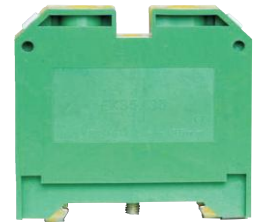

EK 35/35

1. Specification

Terminal Connector	JXB-2.5/35	JXB-4/35	JXB-6/35	JXB-10/35	JXB-16/35	JXB-35/35	JXB-50/35	JXB-70/35	JXB-95/35	JXB-150/35
Earth Connector	EK-2.5/35	EK-4/35	EK-6/35	EK-10/35	EK-16/35	EK-35/35				



URTK

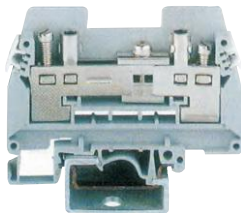

URTKSS



E/UK



End Stopper

Nylon Cable Tie

1. Application

Material: Nylon 66, 94V-2

Heat-resisting, erosion control & insulate.

Operating temperature: -40°C to 85°C.

Color: Natural (or white, standard color), UV black and other colors are available as requested.

2. Specification

Item NO.	L (mm)	W (mm)	Bundle diameter (mm)	Min.loop tensile strength	
		Model A		LBS	KGS
3 x 60	60	2.5	2-11	18	8
3 x 80	80	2.5	2-16	18	8
3 x 90	90	2.5	2-18	18	8
3 x 100	100	2.5	2-22	18	8
3 x 120	120	2.5	2-0	18	8
3 x 140	140	2.5	2-33	18	8
3 x 150	150	2.5	2-35	18	8
3 x 160	160	2.5	2-40	18	8
3 x 200	200	2.5	3-50	18	8
4 x 140	140	3.6	3-33	40	18
4 x 150	150	3.6	3-35	40	18
4 x 180	180	3.6	3-42	40	18
4 x 200	200	3.6	3-50	40	18
4 x 250	250	3.6	3-65	40	18
4 x 280	280	3.6	3-70	40	18
4 x 300	300	3.6	3-80	40	18
4 x 370	370	3.6	3-102	40	18
5 x 120	120	4.8	3-24	50	22
5 x 180	180	4.8	3-42	50	22
5 x 190	190	4.8	3-46	50	22
5 x 200	200	4.8	3-50	50	22
5 x 250	250	4.8	3-65	50	22
5 x 280	280	4.8	3-70	50	22
5 x 300	300	4.8	3-82	50	22
5 x 350	350	4.8	3-90	50	22
5 x 380	380	4.8	3-102	50	22
5 x 400	400	4.8	3-105	50	22
5 x 430	430	4.8	3-110	50	22
5 x 450	450	4.8	3-130	50	22
8 x 150	150	7.6	3-33	120	55
8 x 180	180	7.6	3-42	120	55
8 x 200	200	7.6	3-50	120	55
8 x 250	250	7.6	4-63	120	55
8 x 300	300	7.6	4-82	120	55
8 x 350	350	7.6	4-90	120	55
8 x 400	400	7.6	4-105	120	55
8 x 450	450	7.6	4-118	120	55
8 x 500	500	7.6	4-150	120	55
9 x 550	550	9.0	8-160	175	80
9 x 650	650	9.0	8-190	175	80
9 x 760	760	9.0	10-225	175	80
9 x 920	920	9.0	10-265	175	80
9 x 1020	1020	9.0	10-295	175	80
10 x 450	450	10.0	10-125	200	91
10 x 500	500	10.0	12-150	200	91
10 x 600	600	10.0	12-175	200	91
10 x 700	700	10.0	12-205	200	91
12 x 650	650	12.0	14-190	250	114
12 x 750	750	12.0	10-220	250	114

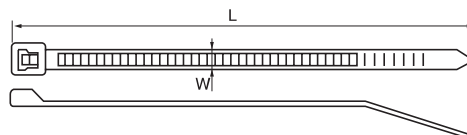

Cable Clips

- PE(white, grey), elasticity and shock resisting.
- Inserting type, nail attached in clips.
- Save time and cost.

1. Specification

Round nail clips

Item.No.	H (mm)	D (mm)	Nail
R-3.5MM	4.5	3.5	1.7 x 14
R-4MM	5.3	4.0	1.7 x 14
R-5MM	6.3	5.0	1.7 x 14
R-6MM	7.4	6.0	1.85 x 16
R-7MM	8.4	7.0	1.85 x 18
R-8MM	9.4	8.0	1.95 x 19
R-9MM	10.4	9.0	2.05 x 22
R-10MM	11.4	10.0	2.20 x 23
R-12MM	13.4	12.0	2.35 x 25
R-14MM	16.4	14.0	2.35 x 30
R-16MM	17.7	16.0	2.35 x 32
R-18MM	19.7	18.0	2.6 x 38
R-20MM	22.2	20.0	2.7 x 40
R-22MM	25.0	22.0	2.9 x 43
R-25MM	27.7	25.0	3.2 x 50
R-30MM	33.1	30.0	3.5 x 55
R-32MM	35.6	32.0	3.5 x 55
R-35MM	36.6	35.0	3.5 x 60
R-40MM	45.2	40.0	3.5 x 65

Flat nail clips

Item.No.	H (mm)	A (mm)	B (mm)	Nail
F-4MM	6.0	3.8	4	1.7 x 14
F-5MM	6.0	3.8	5	1.7 x 14
F-6MM	6.5	4.1	6	1.7 x 16
F-7MM	7.0	4.7	7	1.9 x 16
F-8MM	7.5	5.0	8	2.1 x 19
F-9MM	8.2	5.4	9	2.1 x 20
F-10MM	8.6	5.7	10	2.3 x 21
F-12MM	9.0	6.1	12	2.3 x 23
F-14MM	11.0	8.0	14	2.3 x 25

Coaxial cable nail clips

Item.No.	Width (mm)	Nail
C-0305	3-5	1.2 x 20.0
C-0406	4-6	1.4 x 20.5
C-0508	5-8	2.0 x 25.5
C-0607	6-7	2.0 x 20.0
C-0610	6-10	2.0 x 25.5
C-0812	8-12	2.0 x 30.0
C-1014	10-14	2.0 x 30.5

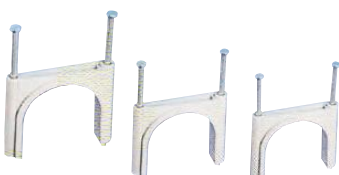
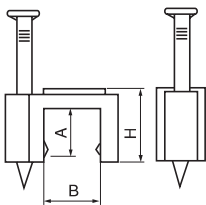
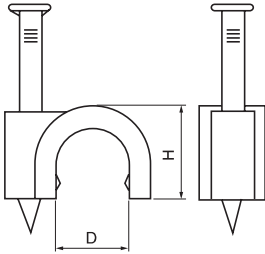

P6 End Wire Connector

- Material: Nylon 66, 94V-2
- Usage: Peel the coat of wire, then insert to tube, use pincers to fix them.
- Feature: Nylon shell, long copper tube, easy to conduct electricity and hold wire tightly.



Item.No.	A (mm)	W		D (mm)	Suitable Wires	
		B (mm)	C (mm)		mm ²	AWG
P6-Ø3	17.8	7.2	3.6	2.5	1.25	22-16
P6-Ø4	21.0	8.2	4.0	2.9	2	16-14
P6-Ø5	22.5	9.0	4.8	3.9	5.5	12-10
P6-Ø6	25.0	10.0	5.6	4.5	8	8
P6-Ø8	25.6	11.8	7.5	6.0	13	6
P6-Ø10	29.5	13.5	9.3	7.5	16	4

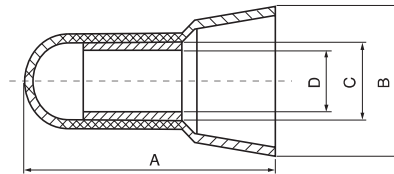

P7 Self-screw Shell End Wire Connector

- Material: Nylon 66, with spring inside.
- Usage: peel wire coat, insert the wire in, then tighten.



Item.No.	H (mm)	W (mm)	D (mm)	Suitable Wire (mm)
P7-1	15	8.7	6.5	MIN#20 x 1+#22 x 1, MAX#16 x 2
P7-2	18	10.0	7.5	MIN#20 x 3, MAX#16 x 3
P7-3	23	11.2	9.5	MIN#20 x 3, MAX#16 x 3+#18 x 1
P7-4	24.2	13.6	10.8	MIN#14 x 1+#18 x 1, MAX#14 x 4+#18 x 1
P7-5	27.8	16.1	12.7	MIN#14 x 2, MAX#10 x 2+#12 x 2

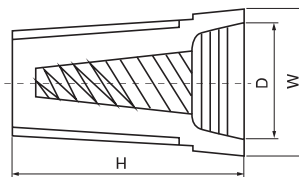

P8 Double Wings End Wire Connector

- Material: Nylon 66, with spring inside.
- Usage: peel wire coat, insert the wire in, then tighten.



Item.No.	H (mm)	W (mm)	D (mm)	Wrapping Range (mm)	Color
P8-1	22.0	19.0	9.8	MIN#18 x 2, MAX#12 x 3	Yellow
P8-2	29.0	22.0	12.5	MIN#14 x 2, MAX#10 x 4	Red

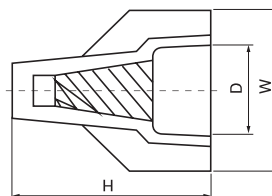

Self-Adhesive Cable Tie Base

- Material: Nylon 66, 94V-2, the back attached foam type double coated tape
- Application: for bundling wires and other things. Used for the places where you don't drill hole

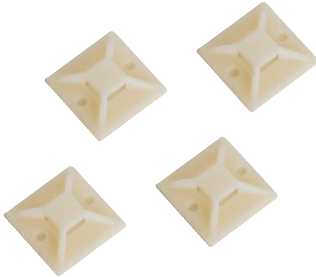

1. Specification

Item.No.	L x W	H (mm)	T (mm)	Screw Hole (mm)
TM-20	20 x 20	6.1	5.0	2.9
TM-25	25 x 25	7.5	6.2	3.5
TM-30	30 x 30	8.7	6.4	4.5
TM-40	40 x 40	6.4	10.8	/

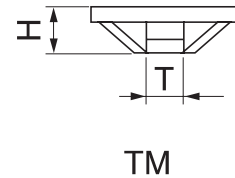
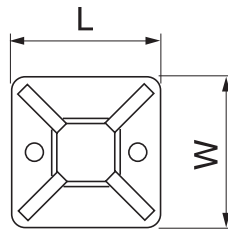

Spiral Wrapping Band

- Material: Made of PE
- Usage: Fix one end with safety belt first, then circle the wires clockwise to make them tighten.
- Application: a protection wear for electric wires, and make them insulation and look nice.

1. Specification

Item.No.	D (mm)	d (mm)	W (mm)	Wrapping Range (mm)	Packing
SWB-03	1.5	3.0	4.0	1.5-10	10M/Roll
SWB-06	4	6	7.0	4-50	
SWB-08	6	8	10.8	6-60	
SWB-10	7.5	10	11.4	7.5-60	
SWB-12	9	12	13.9	9-65	
SWB-15	12	15	15.0	12-75	
SWB-19	15	19	18.2	15-100	
SWB-24	20	24	19.6	20-130	
SWB-30	26	30	43	26-150	

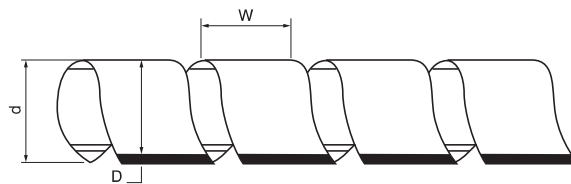

Expand Nail



- Material: made of PE.
- Color: White, Grey.

Item.No.	L (mm)	D (mm)	d (mm)
EN-06	29.8	6.0	4.9
EN-08	38.6	7.9	5.3
EN-10	42.7	9.9	5.8
EN-12	47.9	11.6	6.3

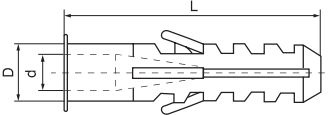

Cable Marker

- Material: made of PVC, oil and erosion control, heat resisting up to 85°C,
- Struction: the inside is hollow, but elastic. The diameter can change with the needed wire.

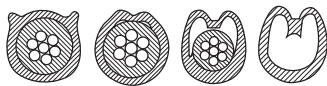

Item.No.	Approx Wire		Packing	Length (m)	markers
	SQ (mm ²)	mm			
EC-0	0.75	0.75	1000PCS/Roll	4.5	0~9 A~Z + - / \ black
	0.75-3.0	1.0	1000PCS/Roll	4.5	
	1.5-3.0	1.5	1000PCS/Roll	4.5	
EC-1	2.6-4.2	2.5	1000PCS/Roll	4.5	
EC-2	3.6-7.4	4	500PCS/Roll	2.75	
EC-3	5-10	6	350PCS/Roll	1.95	
	8-11.9	8	250PCS/Roll	1.37	
	10	10	180PCS/Roll	0.99	
	16	16	80PCS/Roll	0.80	
EC-J	3.6-7.2	4	500PCS/Roll	2.5	

Cable Marker Strip



- Material: Nylon66 94V-2
- Usage: Nylon Plate with cable tie fastening hole to accommodate marker pieces for easy identification of cable runs.

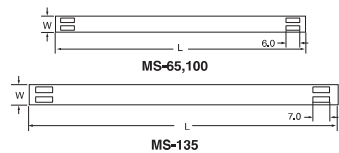

Item.No.	Length (mm)	Width (mm)	Cable tie hole (mm)	Available loaded quantity of FM-1 Cable Marker	Packing
MS-65	65	9	6.7	9pcs	100
MS-90	90	9	6.7	14pcs	100
MS-100	100	9	7.0	16pcs	100
MS-130	130	9	7.0	23pcs	100
MS-135	135	9	13.0	21pcs	100
MS-180	180	9	13.0	30pcs	100

Din Rails

1. Application

Suitable for mounting various modular units.

2. Technical Data

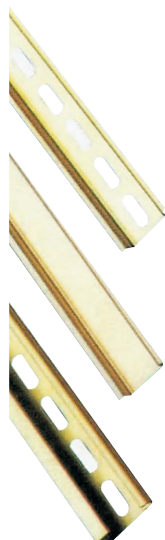

DR101

- Material: steel, zinc electroplated with yellow achromate passivation. aluminium alloy optional.
- Color: yellow or silver gray.
- Length: 2m, 1m and other lengths upon request.
- Standards: DIN 46277, CENELEC EN 50.0222, EN50.023, EN50.035.

Cat.No.: DR101

DR102

Dimensions (mm): 35 × 7.5 × 1(W × H × T)

Length Meters(m): 1, 2

Cat.No.: DR102

DR201

Dimensions (mm): 35 × 7.5 × 1(W × H × T)

Length Meters(m): 1, 2

Cat.No.: DR201

Dimensions (mm): 35 × 15 × 1.5(W × H × T)

Length Meters(m): 1, 2

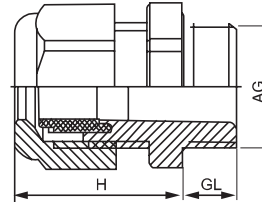
PG Cable Gland**1. Specification**

Model	\varnothing (mm)	GL (mm)	H (mm)	 (mm)
PG7	3-6.5	8	22	16
PG9	4-8	8	26	19
PG11	5-10	8	27	22
PG13.5	6-12	9	28	24
PG16	10-14	10	30	27
PG21	13-18	10	35	33
PG29	18-25	12	40	41/42
PG36	20-32	14	48	52/53
PG42	32-38	14	49	60/61
PG48	37-44	14	50	64/65
PG63	42-50	27	60	81

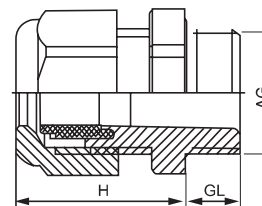
PGL Cable Gland**1. Specification**

Model	\varnothing (mm)	GL (mm)	H (mm)	 (mm)
PGL-7	3-6.5	15	22	16
PGL-9	4-8	15	26	19
PGL-11	5-10	15	27	22
PGL-13.5	6-12	15	28	24
PGL-16	10-14	15	30	27
PGL-21	13-18	15	35	33
PGL-29	25-28	18	40	41
PGL-36	22-32	18	48	52/53
PGL-42	32-38	18	49	60/61
PGL-48	37-44	18	50	64

JG Insulating Closeover

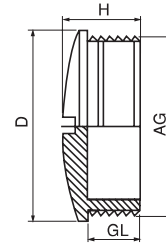
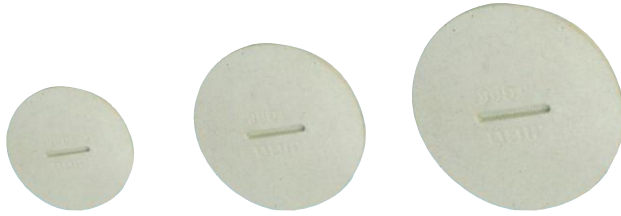

1. Specification

Model	GL (mm)	H (mm)	D (mm)
JG7	6	8	15
JG9	6	9	19
JG11	6	9	22
JG13.5	6	9.5	25
JG16	6	9.5	27
JG21	8	11	33
JG29	8	12	44
JG36	10	15	55
JG42	10	16	62
JG48	12	16	69

Color: light grey or black

PG-N Cable Gland

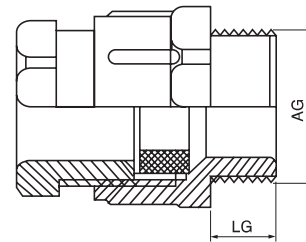

1. Specification



Model	\varnothing (mm)	GL (mm)
PG-7N	5-7	8
PG-9N	6-8	8
PG-11N	8-10	8
PG-13.5N	10-12	9
PG-16N	12-14	10
PG-21N	15-17	11
PG-29N	24-26	11
PG-36N	31-33	13
PG-42N	39-41	13
PG-48N	45-47	14

Color: light grey or black

MG Cable Gland



1. Specification

Model	 (mm)	C1 (mm)	C2 (mm)	 (mm)
MG12	3-5.3	12	9	17/19
MG16	4-7	16	15	22
MG20	6-11	20	15	26/27
MG25	10-16	25	15	32/33
MG32	15-22	32	15	41
MG40	20-25	40	20	50
MG50	26-32	50	23	60/62
MG63	38-46	63	24	73/75

PG-T Metal Cable Gland



1. Specification

Model	 (mm)	GL (mm)	GL(Long) (mm)	H (mm)	 (mm)
PG-T7	3-6.5	5	10	19	14
PG-T9	4-8	6	10	20	17
PG-T11	5-10	6	10	21	20
PG-T13.5	6-12	6.5	10	22	22
PG-T16	10-14	6.5	10	23	24
PG-T21	13-18	7	12	25	30
PG-T29	18-25	8	12	29	40
PG-T36	22-32	8	15	35	50
PG-T42	32-38	9	15	37	57
PG-T48	37-44	10	15	38	64

Wiring Duct(Slotted)

- Material: made of PVC(grey), good insulation and heat-resisting up to 85°C.
- Struction: made up to duct bottom and lid, with two out-holes designed at the bottom.

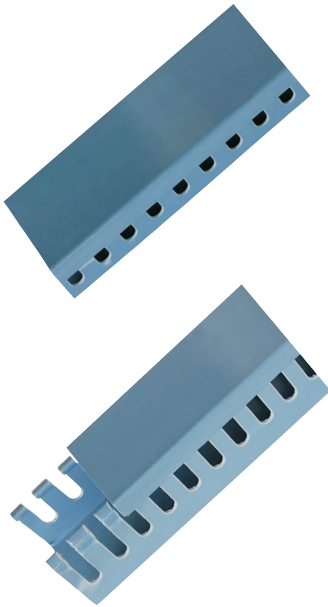

Item.No.	H x W	Contained Wire (1.5mm ²)	Length
PXC-2015	20 x 15	5-10PCS	2M
PXC-2020	20 x 20	10-15PCS	
PXC-2025	20 x 25	10-20PCS	
PXC-2525	25 x 25	10-25PCS	
PXC-2545	25 x 45	25-40PCS	
PXC-3015	30 x 15	5-15PCS	
PXC-3020	30 x 20	10-20PCS	
PXC-3025	30 x 25	15-25PCS	
PXC-3030	30 x 30	20-30PCS	
PXC-3035	30 x 35	30-45PCS	
PXC-3040	30 x 40	35-50PCS	
PXC-3050	30 x 50	45-60PCS	
PXC-3525	35 x 25	25-35PCS	
PXC-3535	35 x 35	40-55PCS	
PXC-4025	40 x 25	20-40PCS	
PXC-4030	40 x 30	35-50PCS	
PXC-4035	40 x 35	40-50PCS	
PXC-4040	40 x 40	45-55PCS	
PXC-4060	40 x 60	60-80PCS	
PXC-4525	45 x 25	25-40PCS	
PXC-4535	45 x 35	40-55PCS	
PXC-4545	45 x 35	60-70PCS	
PXC-5015	50 x 15	25-35PCS	
PXC-5025	50 x 25	25-45PCS	
PXC-5030	50 x 30	30-55PCS	
PXC-5035	50 x 35	50-60PCS	
PXC-5040	50 x 40	60-70PCS	
PXC-5045	50 x 45	70-85PCS	
PXC-5050	50 x 50	90-100PCS	
PXC-5055	50 x 55	100-110PCS	
PXC-5060	50 x 60	95-105PCS	
PXC-5080	50 x 80	180-200PCS	
PXC-50100	50 x 80	220-250PCS	
PXC-6040	60 x 40	90-100PCS	
PXC-6060	60 x 60	140-160PCS	
PXC-6525	65 x 25	100-110PCS	
PXC-6545	65 x 45	180-200PCS	
PXC-6565	65 x 65	140-160PCS	
PXC-8035	80 x 35	160-180PCS	
PXC-8045	80 x 45	180-200PCS	
PXC-8050	80 x 50	200-220PCS	
PXC-8055	80 x 55	240-290PCS	
PXC-8080	80 x 80	280-350PCS	
PXC-80100	80 x 100	300-400PCS	
PXC-100100	100 x 100	300-400PCS	

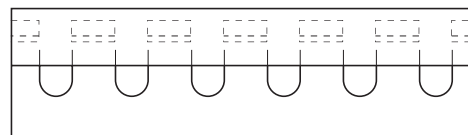
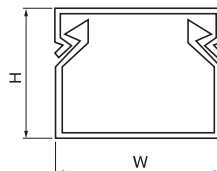

PZC Wiring Duct

- Material: made of PVC(White), good insulation and heatresisting up to 85°C.
- Struction: made up of duct bottom and lid.
- Application: used in stage, electric, air conditioning or indoors.
- Feature: solid design, especially for anti-dust and mouse.

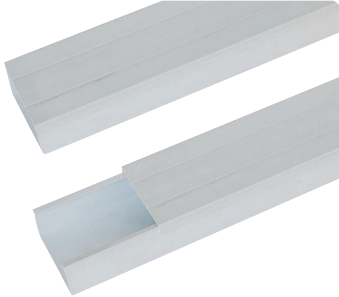

Item.No.	H x W (mm)	Contained Wire (1.5mm ²)	len9th
PZC-1015	10 x 15	3-5PCS	2M
PZC-1020	10 x 20	3-6PCS	
PZC-1025	10 x 25	5-10PCS	
PZC-1525	15 x 25	5-10PCS	
PZC-2030	20 x 30	10-20PCS	
PZC-2035	20 x 35	15-25PCS	
PZC-2540	25 x 40	20-40PCS	
PZC-3050	30 x 50	30-50PCS	
PZC-3060	30 x 60	55-65PCS	
PZC-5080	50 x 80	180-200PCS	
PZC-50100	50 x 100	220-250PCS	
PZC-80100	80 x 100	260-350PCS	
PZC-100100	100 x 100	300-400PCS	

Telephone Wiring Duct

- Material: made from PVC(White), good insulation and heatresisting up to 85°C.
- Feature: spacious designed, and the strong adhesive tape in the duct button.

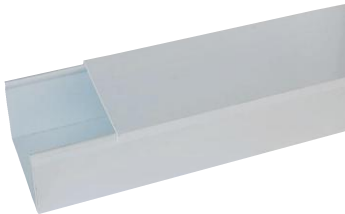

Item.No.	W1(mm)	W2(mm)	H(mm)	L (mm)
JTD-1	10.40	7.30	8.0	1M
JTD-2	14.50	11.80	8.0	
JTD-3	17.50	15.60	11.0	
JTD-4	23.50	19.50	12.0	

Round Type Wiring Duct

- Material: High impact, rigid, self-extinguishing P.V.C
- Service temperature: 85°C
- Backed with high quality double sided tape for permanent stick.

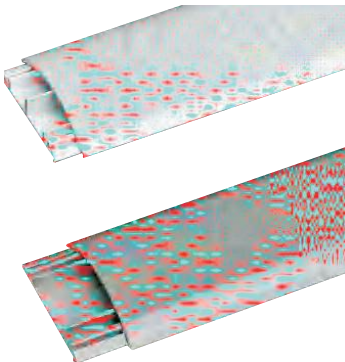

Item.No.	W1(mm)	W2(mm)	Length	color
RTD-1	24	8	1M	White Grey Green
RTD-2	31.7	8.5		
RTD-3	39.2	11		
RTD-4	52	11.3		
RTD-5	63	12.5		
RTD-6	70	13.2		

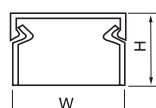

PZC Wiring duct

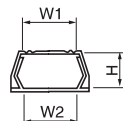

Telephone wiring duct

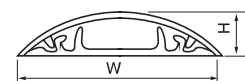











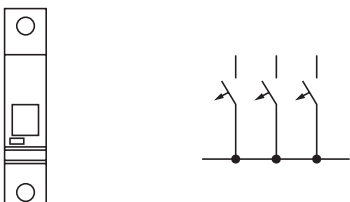

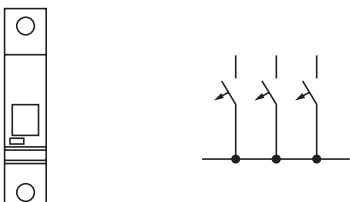

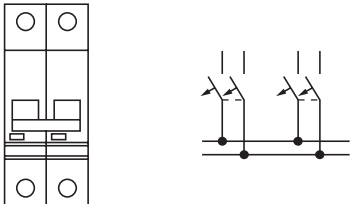
Round type wiring duct

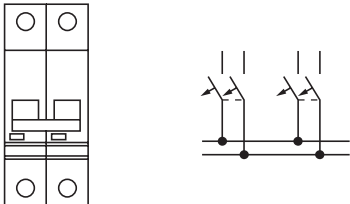
Comb Busbar

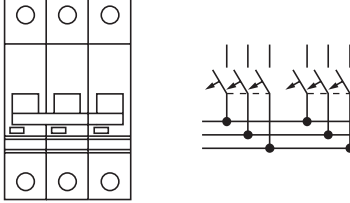
1. Application

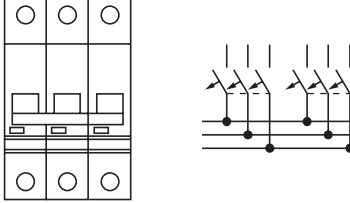
- The busbars ease wiring of electrical item, enlarge connection area, decrease temperature rise and thus increase the electrical reliability of electrical items.
- Material is fire-resistant PVC and red copper
- Current rating is up to 100A
- Rated voltage is up to 415V
- Applicable ambient temperature -25°C~+50°C
- Standard length 1m, other length to be made as requested.

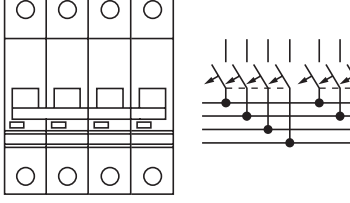
2. Specification

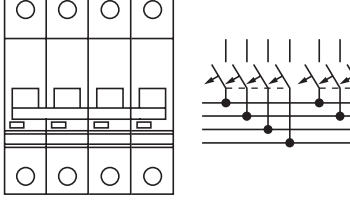
Busbar connection		Rated Current (A)	Number of Poles	Cross Section (mm)	Length (mm)
 Pin type	For single pole MCBs 	63	54 x 1	20	100
		100	54 x 1	20	100
 Fork type		63-100	54 x 1	20	100
 Pin type	For 2 pole MCBs & single pole MCBs with disconnecting neutral NA 	63	27 x 2	20	100
		100	27 x 2	20	100
 Fork type		63-100	27 x 2	20	100
 Pin type	For 3 pole MCBs 	63	18 x 3	20	100
		100	18 x 3	20	100
 Fork type		63-100	18 x 3	20	100
 Pin type	For 4 pole MCBs & 3 pole MCBs with disconnecting neutral NA 	63	14 x 4	20	100
		100	14 x 4	20	100
 Fork type		63-100	14 x 4	20	100

Heat Shrinkable Kits

Heat Shrinkable Anti-tracking Tube

Anti-tracking tube is applied for the power cable terminations accessories with insulation, resistance to weather and UN-ray, even in severest outdoor conditions.

Size: Ø30/12, Ø35/15, Ø40/18, Ø50/20, Ø50/75, Ø60/25, Ø70/25.

Heat Shrinkable Stress Control Tube

Stress control tube control the electrical stress at the end of the copper screen.

Size: Ø30/12, Ø35/15, Ø40/18, Ø50/20, Ø50/25, Ø60/25.

Heat Shrinkable Oil-resisi Ant Tube

Heat shrinkable oil-resistant is applied to PILC cable for preventing the cable oil from dripping out and increasing the insulation.

Size: Ø25/10, Ø30/14, Ø60/20.

Heat Shrinkable Semi-conductive Tube

Semi-conductive tube is mainly applied for the XLPE or PILC power cables in order to improve the cable surface screen.

Size: Ø30/12, Ø35/12, Ø40/14, Ø45/14, Ø50/18, Ø55/18, Ø60/20, Ø65/20, Ø70/20.

Heat Shrinkable Anti-breakout

Heat shrinkable anti-breakout is applied to branch of power cable. Its action is airproof.

Heat Shrinkable Accessories

11kV Heat Shrinkable Kits

Type		Out Door		In Door		Joint Kits	
No.	Diameter mm ²	Single Pole	Three Pole	Single Pole	Three Pole	Single Pole	Three Pole
1	25-50	WSY-10/1.1	WSY-10/3.1	NSY-10/1.1	NSY-10/3.1	JSY-10/1.1	JSY-10/3.1
2	70-120	WSY-10/1.2	WSY-10/3.2	NSY-10/1.2	NSY-10/3.2	JSY-10/1.2	JSY-10/3.2
3	150-240	WSY-10/1.3	WSY-10/3.3	NSY-10/1.3	NSY-10/3.3	JSY-10/1.3	JSY-10/3.3
4	300-630	WSY-10/1.4	WSY-10/3.4	NSY-10/1.4	NSY-10/3.4	JSY-10/1.4	JSY-10/3.4

11kV Oiled XLPE Heat-Shrinkable Kits

Type		Out Door Type		In Door Type		Joint Kits	
No.	Diameter mm ²	Single Pole	Three Pole	Single Pole	Three Pole	Single Pole	Three Pole
1	25-50	WSZ-10/1.1	WSZ-10/3.1	NSZ-10/1.1	NSZ-10/3.1	JSY-10/1.1	JSY-10/3.1
2	70-120	WSZ-10/1.2	WSZ-10/3.2	NSZ-10/1.2	NSZ-10/3.2	JSY-10/1.2	JSY-10/3.2
3	150-240	WSZ-10/1.3	WSZ-10/3.3	NSZ-10/1.3	NSZ-10/3.3	JSY-10/1.3	JSY-10/3.3

35kV XLPE Heat-Shrinkable Kits

Type		Out Door		Out Door	
No.	Diameter mm ²	Single Pole	Three Pole	Single Pole	Three Pole
1	50-120	WSY-35/1.1	WSY-35/3.1	NSY-35/1.1	NSY-35/3.1
2	150-300	WSY-35/1.2	WSY-35/3.2	NSY-35/1.2	NSY-35/3.2
3	400-630	WSY-35/1.3	WSY-35/3.3	NSY-35/1.3	NSY-35/3.3



Lock



240-3/A

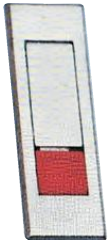

240-3/B



480-3-2



601



603



501-2



301-1



480-1



480-2

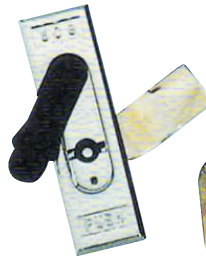

508



402 (18 x 16)



403 (18 x 20)



405 (18 x 30)



401



407



GCS



240



250



88-1



88-2



MS-3



KY-2

Lock



GGD-1



GGD-2



99-B2



99-B1

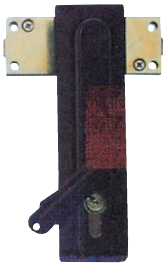

100-5



100-1



100-3



970



308-2



305A



308-3



305B



306



307



30211



3021

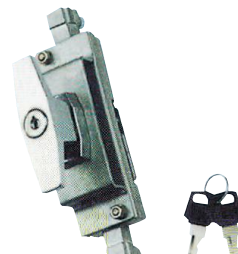

100-2

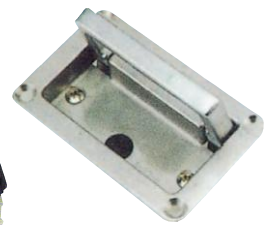

HJ-010



B



107-B



708



708-2

AC-Axial Fan



AD0822A



AD0922A



AD1222A

Type	Air flow (m ³ /h)	Nominal voltage (V)	Frequency (Hz)	Power input (Watt)	Sintec~ball bearings		Dimension (mm)
					■ Sleeve bearings	■ bearings	
AD0822ASN	29	230	50	10		■	80 x 80 x 25
AD0822ABN	29	230	50	10	■		
AD0822ASH	35	230	50	11.5		■	
AD0822ABH	35	230	50	11.5	■		
AD0821ASN	30	115	60	11		■	
AD0821ABN	30	115	60	11	■		
AD0821ASH	36	115	60	12		■	92 x 92 x 25
AD0821ABH	36	115	60	12	■		
AD0922ASN	35	230	50	9		■	
AD0922ABN	35	230	50	9	■		
AD0922ASH	49	230	50	12		■	
AD0922ABH	49	230	50	12	■		
AD0921ASN	43	115	60	11		■	108 x 108 x 25
AD0921ABN	43	115	60	11	■		
AD0921ASH	60	115	60	12		■	
AD0921ABH	60	115	60	12	■		
AD1122ASN	61	230	50	13		■	
AD1122ABN	61	230	50	13	■		
AD1122ASH	75	230	50	15		■	120 x 120 x 25
AD1122ABH	75	230	50	15	■		
AD1121ASN	64	115	60	14		■	
AD1121ABN	64	115	60	14	■		
AD1121ASH	82	115	60	15.5		■	
AD1121ABH	82	115	60	15.5	■		
AD1223ASH	120	380	50	15.5	■		120 x 120 x 25
AD1223ABH	120	380	50	15.5			
AD1222ASN	108	230	50	14		■	
AD1222ABN	108	230	50	14	■		
AD1222ASH	125	230	50	16		■	
AD1222ABH	125	230	50	16	■		
AD1221ASN	115	115	60	15		■	120x 120 x 38
AD1221ABN	115	115	60	15	■		
AD1221ASH	130	115	60	16.5		■	
AD1221ABH	130	115	60	16.5	■		
AD1233ASN	135	380	43	21		■	
AD1233ABN	135	380	43	21	■		
AD1233ASH	160	380	48	22		■	120x 120 x 38
AD1233ABH	160	380	48	22	■		
AD1232ASN	140	230	44	21		■	
AD1232ABN	140	230	44	21	■		
AD1232ASH	155	230	49	22		■	
AD1232ABH	155	230	49	22	■		

AC-Axial Fan



AD1232A



AD125FzY



AD1550A

Type	Air flow (m³/h)	Nominal voltage (V)	Frequency (Hz)	Power input (Watt)	Sintec-ball bearings		Dimension (mm)
					■ Sleeve bearings	■ bearings	
AD1231ASN	140	115	44	22		■	120 x 120 x 38
AD1231ABN	140	115	44	22	■		
AD1231ASH	165	115	49	23		■	
AD1231ABH	165	115	49	23	■		
AD125FZY3-S	230	380	50	26	■		135 x 135 x 32
AD125FZY3-B	230	380	50	26			
AD125FZY2-S	180	230	50	24.5		■	
AD125FZY2-B	180	230	50	24.5	■		
AD125FZY2-S	210	230	50	25		■	
AD125FZY2-B	210	230	50	25	■		
AD125FZY1-S	190	115	60	24.5		■	
AD125FZY1-B	190	115	60	24.5	■		
AD125FZY1-S	240	115	60	26		■	120 x 120 x 38
AD125FZY1-B	240	115	60	26	■		
AD1231MABH	94/2.70	115	50	19	■		
AD1231MABH	112/3.20	115	60	18	■		
AD1232MABH	94/2.70	230	50	20	■		120 x 120 x 38
AD1232MABH	112/3.20	230	60	17	■		
AD1233MABH	94/2.70	380	50	32	■		172 x 150 x 51
AD1553ABN	280	380	50	26	■		
AD1553ABH	340	380	50	29	■		
AD1552ASN	280	230	50	24		■	
AD1552ABN	280	230	50	24	■		172 x 150 x 51
AD1552ABH	340	230	50	26.5	■		
AD1551ABN	320	115	60	26	■		150 x 150 x 50
AD1551ABH	370	115	60	28	■		
AD15503ABN	280	380	50	26	■		
AD15503ABH	340	380	50	29	■		
AD15502ASN	280	230	50	24		■	150 x 150 x 50
AD15502ABN	280	230	50	24	■		
AD15502ABH	340	230	50	26.5	■		172 x 172 x 51
AD15501ABN	320	115	60	26	■		
AD15501ABH	370	115	60	28	■		
AD1753ABN	280	380	50	26	■		
AD1753ABH	340	380	50	28	■		
AD1752ASN	280	230	50	24.5		■	172 x 172 x 51
AD1752ABN	280	230	50	24.5	■		
AD1752ABH	340	230	50	28	■		
AD1751ABN	320	115	60	26	■		
AD1751ABH	370	115	60	28	■		
AD145FZy3-S	300	380	50	29	■	■	172 x 145 x 38
AD145FZy3-S	350	380	50	29	■		

AC-Axial Fan



AD1552AB



AD1752AB



AD20060AB

Type	Air flow (m ³ /h)	Nominal voltage (V)	Frequency (Hz)	Power input (Watt)	Sinter-ball bearings		Dimension (mm)
					■ Sleeve bearings	■ Sinter bearings	
AD145FZY2-S	300	230	50	26		■	172 x 145 x 38
AD145FZY2-S	300	230	50	27	■		
AD145FZY2-S	350	230	50	29	■		
AD145FZY1-S	330	115	60	27		■	
AD145FZY1-S	390	115	60	29	■		
AD150FZY1-D	216	115	50	25	■		150 x 160 x 60
AD150FZY2-D	216	220	50	30	■		
AD150FZY7-D/(1)	216	380	50	35	■		
AD150FZY4-D/(3)	216	380	50	40	■		200 x 210 x 71
AD200FZY2-D	459	220	50	65	■		
AD200FZY7-D/(1)	459	380	50	65	■		
AD200FZY4-D/(3)	459	380	50	65	■		180 x 180 x 60
AD1863ABM	420	380	50	48	■	■	
AD1863ABH	420	380	50	49	■		
AD1862ABN	470	230	50	45		■	
AD1862ABM	420	230	50	48	■		
AD1863ABH	450	230	50	49	■		200 x 200 x 60
AD20060MBL-1	245	115	50	65	■		
AD20060MBL-2	285	230	50	70		■	
AD20060MBL-3	285	380	50	70	■		230 x 200 x 65
AD2363ABN	700	380	50	68	■		
AD2363ABM	630	380	50	65	■		
AD2363ABH	850	380	50	65	■		
AD2362ABN	700	230	50	68	■		
AD2362ABM	630	230	50	58	■		225 x 225 x 80
AD2362ABH	850	230	50	65	■		
AD2283ABN	455	380	50	30	■		
AD2283ABH	1030	380	50	80	■		
AD2282ABN	520	230	50	30	■		
AD2282ABM	820	230	50	64	■		Ø 300
AD2281ABN	520	115	60	28	■		
AD2281ABM	1030	115	60	80	■		
ADF4A2-300	1800	230	50	73			Ø 300
ADF4B2-300	2100	230	60	100			
ADF4A3-300	1800	230	50	65			
ADF4B3-300	2100	230	60	80			Ø 350
ADF4A2-350	3100	230	50	130			
ADF4B2-350	3500	230	60	190			
ADF4A3-350	3100	380	50	115			Ø 350
ADF4B3-350	3600	380	60	160			

AC-Axial Fan



AD2362AB

Type	Air flow (m ³ /h)	Nominal voltage (V)	Frequency (Hz)	Power input (Watt)	Sintec-ball bearings		Dimension (mm)
					■ Sleeve bearings	■ bearings	
AD300A2LBL (300FZY2-D)	1320	220	50	80	■		300 x 300 x 100
AD300A3LBL (300FZY3-D)	1320	380	50	80	■		
AD300A3LBL (300FZY4-D)	1320	380	50	80			
AD300A2HBL (300FZY6-D)	2040	220	50	200	■		
AD300A3HBL (300FZY7-D)	2040	380	50	180	■		
AD300A3HBL (300FZY8-D)	2040	380	50	200	■		
AD250A2LBL (250FZY2-D)	720	220	50	40	■		250 x 250 x 90
AD250A3LBL (250FZY3-D)	720	380	50	40	■		
AD250A3LBL (250FZY4-D)	720	380	50	40	■		
AD250A3HBL (250FZY6-D)	1200	220	50	100	■		
AD250A3HBL (250FZY7-D)	1200	380	50	100	■		
AD250A3HBL (250FZY8-D)	1200	380	60	100	■		
AD2260A1HSL-1	335	110	50/60	77/55	■		200 x 200 x 60
AD2260A1HBL-1	335	110	50/60	77/55	■		
AD2260A2HSL-1	335	220	50/60	72/50	■		
AD2260A2HBL-1	335	220	50/60	72/50	■		

Filter

