

# FURUNO®

The new benchmark in autopilots!  
Perfect for a wide range of boats from  
small outboards through power boats.  
Sailboats can take advantage of the  
new wind mode.

## NAVpilot™



NAVpilot-500



NAVpilot-520



NAVpilot-511



The future today with FURUNO's electronics technology.

**FURUNO ELECTRIC CO., LTD.**

9-52 Ashihara-cho, Nishinomiya City, Japan Phone: +81 (0)798 65-2111  
Fax: +81 (0)798 65-4200, 66-4622 URL: www.furuno.co.jp

Catalogue No. M-1532F

TRADE MARK REGISTERED  
MARCA REGISTRADA

# **NAVpilot Steers Your Vessel Straight the First Time and Every Time!**

- Unparalleled “Adaptive” technology allows NAVpilot to continue improving your vessel’s steering on every voyage
- Auto set-up and Self-learning for vessel speed and course
- Versatile, high-resolution LCDs allow for a variety of user-defined display configurations
- One-touch operation for Standby, Auto and Nav modes
- Exclusive FishHunter™ feature guides your vessel in orbit, figure eight or spiral maneuvers around fish targets
- Network up to six full-size NAVpilot-500, compact NAVpilot-511 and/or handheld NAVpilot-520 control units
- The NAVpilot-520 (handheld type) can work as a full-functioned remote control unit within a NAVpilot system
- Multi language: English, French, German, Italian, Portuguese and Spanish
- Optional junction box for NAVpilot 520 is available for remote operation





### **Steering your boat straight the first time and every time.**

Here's the scenario. You're setting out for your favorite destination, the sun is shining and the sky is as blue as the sea. This is the perfect time to let the NAVpilot steer you straight to your waypoint and let you enjoy the sun and the scenery. No matter if it is a stormy day or a beautiful day, the NAVpilot series is what you need to help you arrive at your destination safely.

### **Self-learning and adaptive software.**

Here is the key to how FURUNO has revolutionized the autopilot marketplace with the NAVpilot series. From the first dock-side setup through the last voyage you made, the NAVpilot continues to learn your vessel's

steering characteristics.

This allows for dynamically adjusting the boat's steering for vessel

speed, trim, draft, tide and wind effects, weather, etc. These characteristics are

stored on the processor's memory where they are

continuously optimized to make the NAVpilot more versatile.

### **Perfect for power, sail or work boats.**

With a standard set of features unrivaled by any other autopilot on the market,

the NAVpilot series is perfect for any vessel from sailboats through powerboats and everything in between. Features include Auto Mode - one press of a button turns the steering over to the NAVpilot to free you to monitor your radar, chart plotter, etc.; Advanced Auto Mode - utilizing automatic ground tracking control to steer the vessel; Nav Mode - track control system referenced on a precision cross track error when integrated with GPS navigator; and Wind Mode - allows you to control your sailboat while compensating for the effects of wind and tide.

### **Fishing just got easier with the exclusive FishHunter™** (For power boat only).

FishHunter is a unique feature of FURUNO's NAVpilot series. Find a fish target with your FURUNO sonar/sounder or bird target with your Furuno radar and feed it to the NAVpilot. The NAVpilot will activate the FishHunter mode to perform orbit, spiral or figure eight maneuvers around the specified target. This feature can also be used for Man Overboard (MOB).

#### **Safety notice:**

Autopilot should not be used in congested areas or around obstacles. Switch the autopilot to manual mode whenever potential danger is present. An autopilot is an aid to, not a replacement for, an experienced helmsman.



### **FAP-5001 for NAVpilot-500**

Extra large monochrome LCD  
85 mm (W) x 85 mm (H)  
3.4" (W) x 3.4" (H)

The extra large monochrome LCD displays a variety of information with large easy-to-read characters and graphics. The large control knob allows for precise course changing and straightforward menu selecting.



### **FAP-5021 for NAVpilot-520**

Handheld control unit  
85 mm (W) x 43 mm (H)  
3.4" (W) x 1.7" (H)

A handheld control unit allows for full operation of autopilot from anywhere onboard. Its clear LCD displays various navigation information to assist you in steering your boat.



### **FAP-5011 for NAVpilot-511**

High-resolution monochrome LCD  
85 mm (W) x 43 mm (H)  
3.4" (W) x 1.7" (H)

The compact and waterproof unit can be installed anywhere on any type of boat. Its clear LCD indicates important navigational information, including rudder information.

### **Junction Box (Wall Socket)**



The Junction Box is available for full operation at remote locations. Simply plug a NAVpilot-520 into a Junction Box, located in remote locations onboard, to allow for autopilot operation on the spot.



## Display Modes for NAVpilot-500



Compass Rose

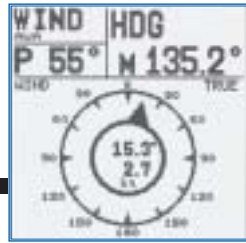

Wind Data

### User Customizable Displays



Two-way split

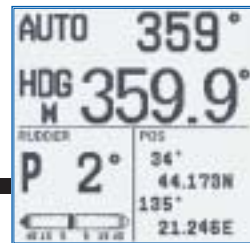

Three-way split

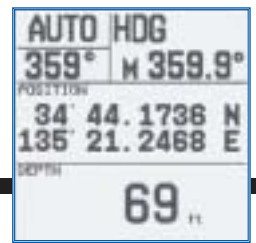

## Display Modes for NAVpilot-511/520

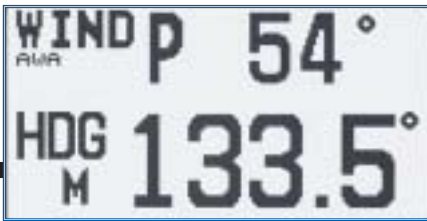

Wind Mode

### User Customizable Displays

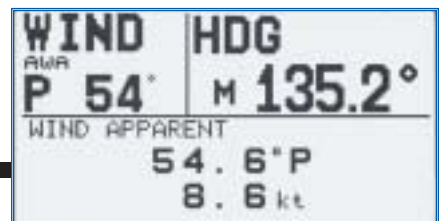
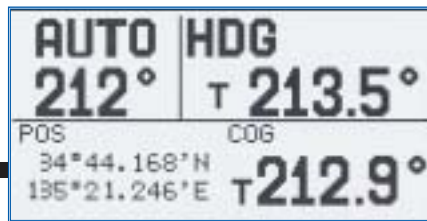

## Remote Control Units

A variety of remote control units are available for the NAVpilot series.

[FAP-5551/5552](#)

[FAP-6211/6212](#)

[FAP-6231/6232](#)



[FAP-6221/6222](#)

## Display Modes

Simple one-touch mode selection provides reliable steering and course control. Multiple customizable display modes include Rudder angle, Heading, Highway, Compass rose, Wind Data, Nav Info, etc.

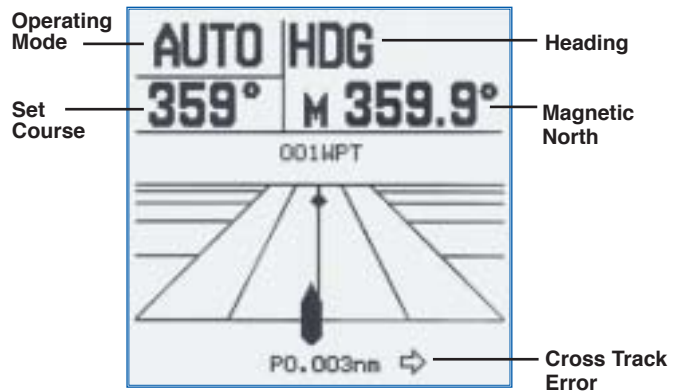

Highway



## Auto mode

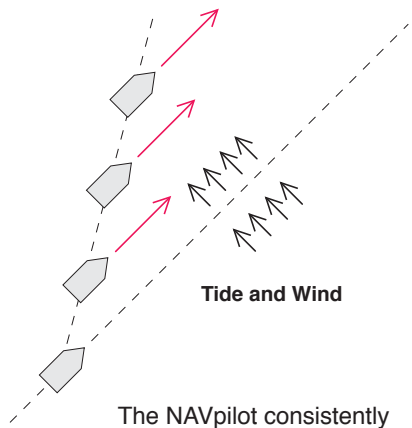

The NAVpilot consistently maintains the pre-set heading, but the vessel may drift away from the intended course due to tide and wind.

## Advanced auto mode

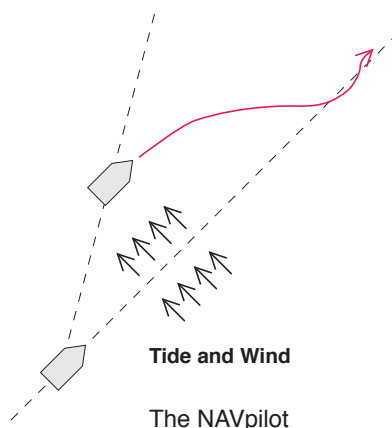

The NAVpilot consistently maintains the pre-set heading, while compensating for the effects of tide and wind.

## Wind mode

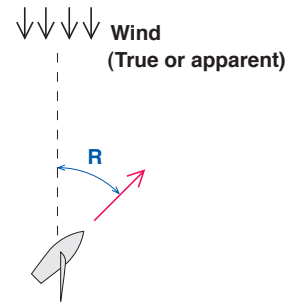

The NAVpilot consistently maintains the pre-set heading at the constant direction toward the true or apparent wind direction, while compensating for the effects of tide and wind.

## Nav mode

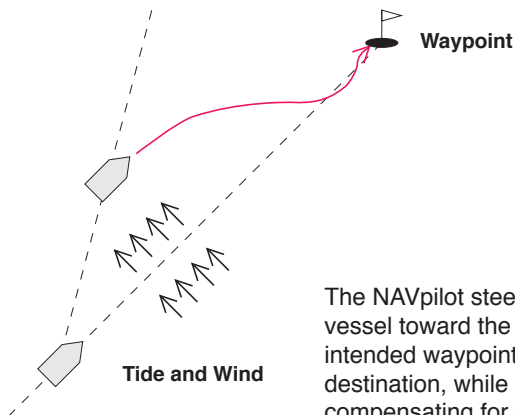

The NAVpilot steers the vessel toward the intended waypoint/destination, while compensating for the effects of tide and wind.

## Route tracking

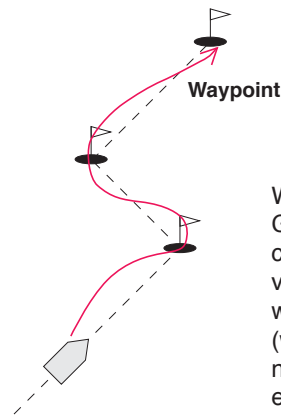

When interconnected with a GPS navigator, the NAVpilot can automatically steer the vessel to follow a series of waypoints in succession (waypoints set by the navigator). On arriving at each waypoint or destination, audio-visual alerts will be activated.

## FishHunter™

The FishHunter™ mode can be activated to automatically set up your boat's steering behavior after it reaches the last waypoint in a route. The radius(L) of each maneuver can be set in the menu.

### Orbit

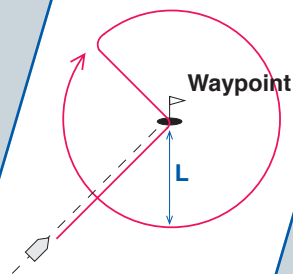

With the Orbit maneuver, the vessel will be steered in a circular pattern around the final waypoint (fishing spot).

### Figure eight



With the Figure eight maneuver, the vessel will continually return to the final waypoint in a figure eight pattern.

### Spiral

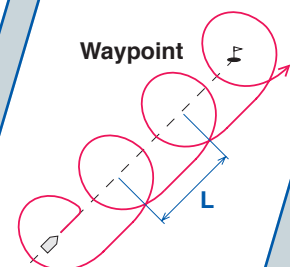

With the Spiral maneuver, the vessel will be steered toward the waypoint spirally.

# System configurations

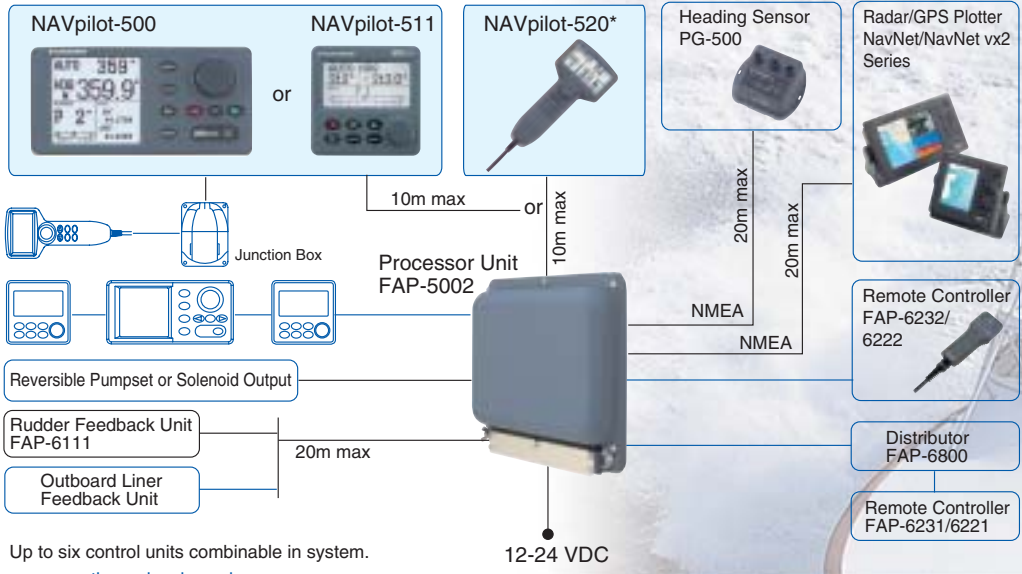

Up to six control units combinable in system.

— option or local supply

\*Any additional control unit cannot be connected from NAVpilot-520.

## for Powerboat

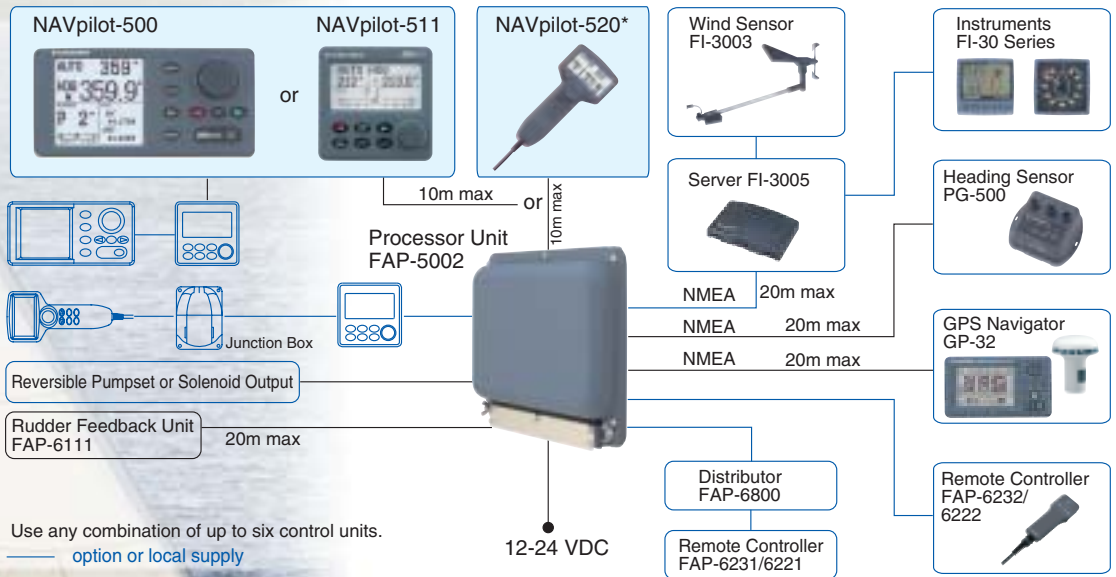

Use any combination of up to six control units.

— option or local supply

\*Any additional control unit cannot be connected from NAVpilot-520.

## for Sailboat

# SPECIFICATIONS OF NAVpilot™

**Operational Mode** Auto, Navigation\*, Wind (Sail boat only), Dodge, Remote\*\*, Fish Hunter™  
 \*Required to connect with external GPS receiver  
 \*\*Optional remote controller required

**Drive System** Reversible Hydraulic (Up to 25 Amp Continuous) or Solenoid Drive Output

**Display Type**  
 FAP-5001: Silver bright LCD, 160 (H) x 160 (V) pixels  
 FAP-5011/5021: Silver bright LCD, 160 (H) x 80 (V) pixels

**Display Modes**  
 FAP-5001: Customizable Heading, Course, Rudder Angle, Highway, Compass, Wind and Navigation Information  
 FAP-5011/5021: Customizable Rudder Angle

**Languages** English, French, German, Italian, Portuguese, Spanish

**External Devices via NMEA0183 Interface;**  
 Heading Sensor: FURUNO PG-500 Fluxgate or Satellite Compass SC-50/110 by NMEA0183 HDG or HDM (5 Hz or higher)  
 Positioning Equipment FURUNO GP-30 Series, GP-7000/7000F, NavNet/NavNet vx2 series, other non-FURUNO GPS receiver (NMEA0183 data required)  
 Wind Sensor FURUNO FI-3003 with server FI-3005 or other non-FURUNO wind sensor (2 Hz or higher)

**Parameters Settings** Auto Setup, Adaptive (Self-learning) with manual setting override: Weather, Rudder ratio, Counter rudder, Course changing rate, Rudder angle limits

**Alarms** Power failure, XTE, Nav signal error, Speed, Arrival, Watch, Temp and Depth

**POWER SUPPLY**  
 12-24 VDC, 3.0 A (excluding pump)  
 10 W with 1 control unit (excluding pump)  
 25 W with 6 control units (excluding pump)

**ENVIRONMENT**  
 Temperature: -15°C to +55° (IEC 60945 test method)  
 Waterproofing: IPX6 (FAP-5021 Control Unit)  
 IPX5 (Control Unit, Rudder Feedback Unit)  
 IPX2 (Processor Unit)

## EQUIPMENT LIST

- Standard**
- Control Unit FAP-5001 for NAVpilot-500, FAP-5011 for NAVpilot-511 or FAP-5021 for NAVpilot-520 (specify when ordering) 1 unit
  - Processor Unit FAP-5002 1 unit
  - Rudder Reference Unit FAP-6111 1 unit
  - Installation Materials and Spare Parts 1 set
- Option**
- Lever Type Remote Controller FAP-6221/6222
  - Dodge Type Remote Controller FAP-6231/6232
  - Mounting Bracket  
 FAP-5001: FP64-01011, FAP-5011: FP64-01101
  - Cable for Control Unit MJ-A7SPF00012-100
  - Interface cable MJ-A7SPF00010-100/150/200
  - Distributor FAP-6800
  - Junction Box FAP-6821

### Control Unit

#### FAP-5001

0.7 kg 1.5 lb

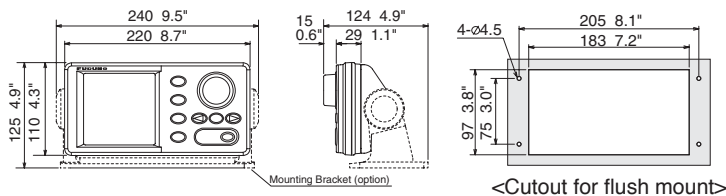

#### FAP-5011

0.3 kg 0.8 lb

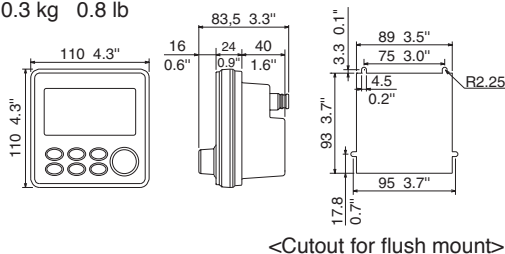

#### FAP-5021

0.4 kg 0.8 lb

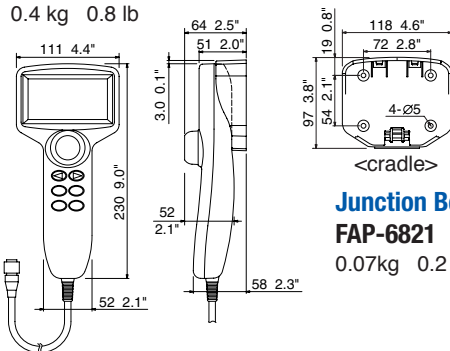

### Junction Box

#### FAP-6821

0.07kg 0.2 lb

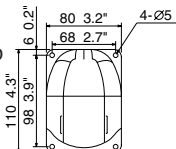

### Remote Controller

#### FAP-5551/5552

(Dial type)  
 0.5 kg 1.1 lb

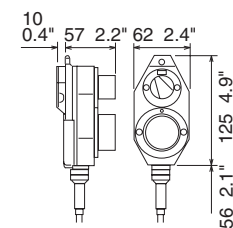

#### FAP-6211/6222

(Button type)  
 0.5 kg 1.1 lb

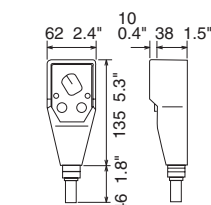

### Processor Unit

#### FAP-5002

1.9 kg 4.2 lb

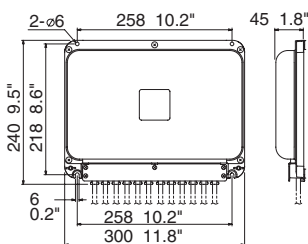

#### FAP-6221/6222

(Lever type)  
 1.8 kg 4.0 lb

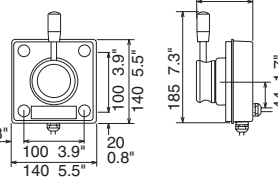

#### FAP-6231/6232

(Dodge type)  
 0.5 kg 1.1 lb

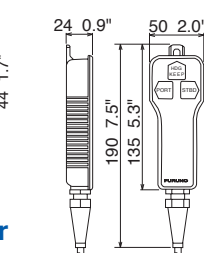

### Rudder Reference Unit

#### FAP-6111

0.5 kg 1.1 lb

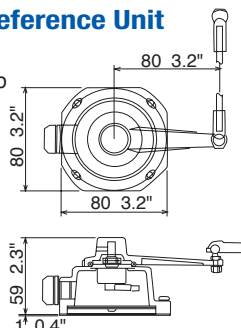

### Heading Sensor

#### PG-500

0.3 kg 0.7 lb

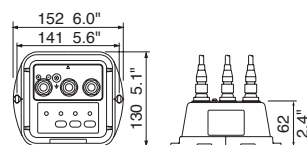

A part of the steering algorithm of the NAVpilot series is developed thanks to the collaboration with FLSI.

SPECIFICATIONS SUBJECT TO CHANGE WITHOUT NOTICE

#### FURUNO U.S.A., INC.

Camas, Washington, U.S.A.  
 Phone: +1 360-834-9300  
 Fax: +1 360-834-9400

#### FURUNO (UK) LIMITED

Denmead, Hampshire, U.K.  
 Phone: +44 2392-230303  
 Fax: +44 2392-230101

#### FURUNO FRANCE S.A.

Bordeaux-Mérignac, France  
 Phone: +33 5 56 13 48 00  
 Fax: +33 5 56 13 48 01

#### FURUNO ESPAÑA S.A.

Madrid, Spain  
 Phone: +34 91-725-90-88  
 Fax: +34 91-725-98-97

#### FURUNO DANMARK AS

Hvidovre, Denmark  
 Phone: +45 36 77 45 00  
 Fax: +45 36 77 45 01

#### FURUNO NORGE A/S

Ålesund, Norway  
 Phone: +47 70 102950  
 Fax: +47 70 127021

#### FURUNO SVERIGE AB

Västra Frölunda, Sweden  
 Phone: +46 31-7098940  
 Fax: +46 31-497093

#### FURUNO FINLAND OY

Espoo, Finland  
 Phone: +358 9 4355 670  
 Fax: +358 9 4355 6710

#### FURUNO POLSKA Sp. z o.o.

Gdynia, Poland  
 Phone: +48 58 669 02 20  
 Fax: +48 58 669 02 21

#### FURUNO DEUTSCHLAND GmbH

Rellingen, Germany  
 Phone: +49 4101 838 0  
 Fax: +49 4101 838 111

#### FURUNO EURUS LLC

Petersburg, Russia  
 Phone: +7 812 767 15 92  
 Fax: +7 812 766 55 52



PRINTED WITH SOYINK 05085SS Printed in Japan

