

FURUNO

RADAR

Model: FAR-28x7 (with 23.1" LCD)



with an optional pedestal



Approved

www.furuno.com

**FURUNO has integrated leading-edge technology
with a user-friendly interface,
providing reliable performance and
simplified installation**

***R*ADAR**



The FAR-28x7 series of X- and S-band, TR-up and-down radars are designed to meet the exacting standards of the International Maritime Organization (IMO) for all ships.

The display unit employs a 23.1" LCD which provides an effective picture diameter of larger than 340 mm. The high-resolution UXGA, digital flat-panel display unit provides crisp and clear radar images through a DVI interface. The DVI interface provides a pure digital video signal by using a digital signal for the entire path which maintains the image quality at the highest level, because the signal is not degraded as a result of a digital-to-analog conversion. The display has selectable color with a day and night background colors for clear presentation in all lighting conditions. Different colors are assigned for marks, symbols and text for easy observation.

Target detection is improved by sophisticated signal processing techniques featuring superb short-range detection. Two guard

zones are provided as automatic acquisition zones for ARPA (TT function). One of two can be set at required ranges and any sector in any form. The FAR-28x7 series can display data about AIS-equipped ships, when connected with an AIS transponder. AIS enhances detection of other ships and AtoN (Aid to Navigation) on radar by displaying their movement and status with easy to read symbols and text.

The radar antenna is available with 4, 6.5, or 8 feet radiator. For the X-band, the rotation speed is selectable from 24 rpm for standard radar or 42 rpm for HSC. The S-band radar is also available with the antenna radiator of 12 feet, and the rotation speed is selectable from 21/26 rpm for standard radar or 45 rpm for HSC application. The S-band radar assures target detection in adverse weather where an X-band is heavily affected by sea or rain clutter.

**X-band antenna
for FAR-2817/2827/2827W**



8 ft antenna
(4 or 6.5 ft also available)



**S-band antenna
for FAR-2837S/2837SW**



12 ft antenna



FAR-2817:	X-band, 12 kW, TR up
FAR-2827:	X-band, 25 kW, TR up
FAR-2827W:	X-band, 25 kW, TR down
FAR-2837S:	S-band, 30 kW, TR up
FAR-2837SW:	S-band, 30 kW, TR down

- ▶ **Advanced signal processing for improved target detection**
- ▶ **High resolution UXGA LCD provides crisp radar images**
- ▶ **Complies with the existing IMO standards for all ships**
- ▶ **Low spurious magnetrons meeting ITU-R unwanted emission standards**
- ▶ **Up to four radars can be interswitched in the network without an extra device**
- ▶ **Automatic plotting/tracking of 100 targets manually or automatically acquired**
- ▶ **Displays 1000 AIS-equipped targets**
- ▶ **Easy operation by customizable function keys, trackball/wheel palm module and rotary controls**
- ▶ **Stylish streamlined design**

This series of radar complies with the latest IMO and IEC regulations:

- IEC 60945
- IEC 61162
- IEC 61993
- IEC 62388
- IMO MSC.191(79)
- IMO MSC.192(79)
- IMO A.694(17)
- IMO A.813(19)
- IMO SN/Circ.217

Utilizing a high speed Ethernet network, the FAR-28x7 series brings flexible system expansion and consolidation to onboard navigation systems

FEATURES of **RADAR** FAR-28x7 series

► 100 Base-TX Ethernet Network System

The radars can be connected to an Ethernet network for a variety of user requirements. Each of the X- and S-band radars can be interswitched without using an extra option. Up to four radars can be interchanged in the network. In addition, the essential navigational information including the electronic chart, L/L, COG, SOG, STW, etc. can be shared in the network.

Independent

Interswitch

Repeater

Other Radar Images, Chart data, Navigational information, etc.

The 100 Base-TX Ethernet is utilized to link up to four sets of radar FAR-21x7/28x7 with the FMD-3100/3200/3300. This link gives high-speed navigational data sharing within the system and allows operators to choose either a single station system or a total bridge system.

Ethernet 100 Base-TX

ECDIS, SDME, GPS Navigator, RADAR

► Stress-free operation with versatile control units

EBL controls

VRM controls

User Customizable Function Keys

Trackball

Menu Item Selector (wheel and enter keys)

Full-keyboard type

The control head has logically arranged controls in a combination of push keys and trackball. Well organized menus ensure that all operations can be done by trackball.

Trackball type

Alternative to the Full-keyboard type or additional as a remote operation.



FUNCTIONS of FAR-28 x 7 series

► TT (ARPA)/AIS

Targets automatically acquired

AIS-equipped target selected for data reading.

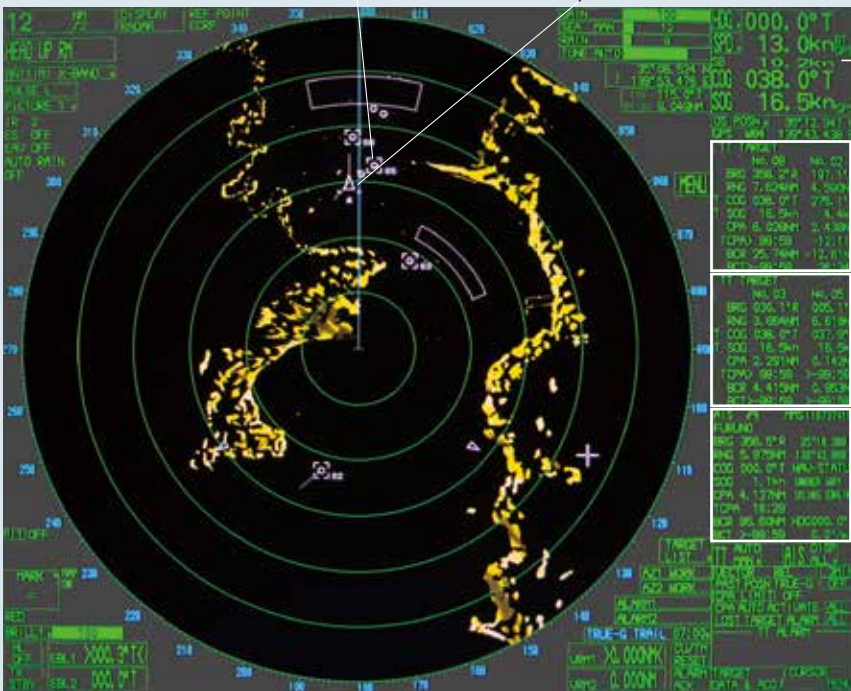

Own ship data cell

DATA Cell 1

Tracking data

Water temp,
Depth,
Wind

DATA Cell 2

Tracking data

Zoom

DATA Cell 3

Tracking data

AIS
Information



Data Display

A variety of navigational information, own ship status, radar plotting data, wind, water temperature and information from other shipborne sensors are displayed on the cells. The FAR-28x7 series has a unique zoom function, which enlarges a part of the radar image twice or three times in size.

Target Association (Fusion)

An AIS-equipped ship may be displayed by both AIS and TT (ARPA) symbols. This is because the AIS position is measured by a GPS navigator in L/L while the TT (ARPA) target blip and data are measured by range and bearing from own ship. When the symbols are within an operator-set criteria, the TT (ARPA) symbol is merged with the AIS symbol. The criteria is determined by the differences in range, bearing, course, speed, etc.

Symbols for AIS

AIS COG/SOG vector changes its length with speed. ROT mark is viewable at the COG/SOG vector tip when a target ship is equipped with a FURUNO satellite compass SC-70/130 or gyrocompass which can talk ROT serial sentence.

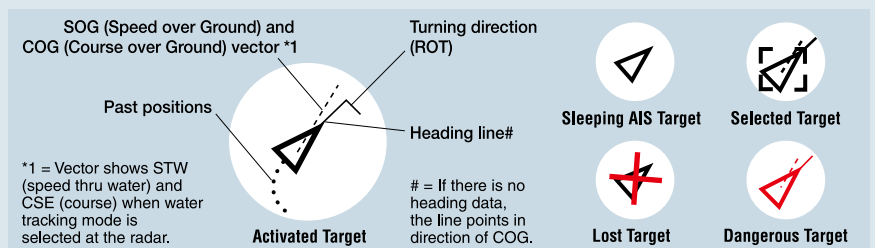

► **Guard Zones**

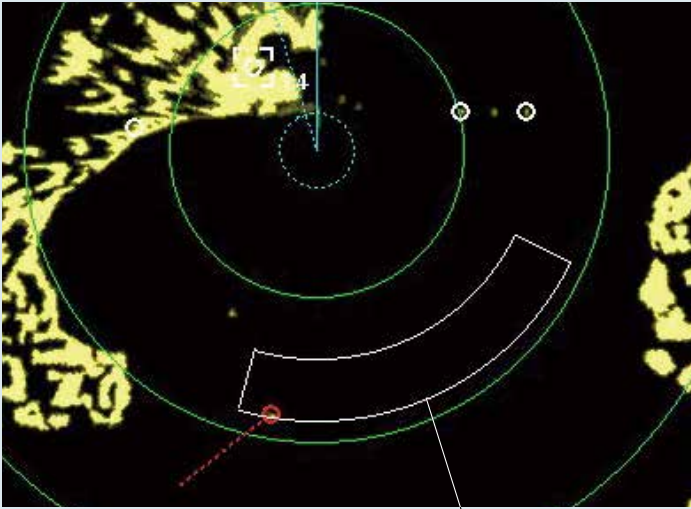

Guard Zones

Automatic Acquisition Zone

Two automatic acquisition zones may be set in a sector or any form. They also act as suppression zones, avoiding unnecessary overloading to the processor and clutter by disabling automatic acquisition and tracking outside them. Targets in an automatic acquisition zone are shown with an inverse triangle. The operator can manually acquire important targets without restriction.

Guard Zones and Anchor Watch Zone

Guard Zones generate visual and audible alarms when targets enter the operator set zones. One of the Guard Zones may be used as an anchor watch to alert the operator when own ship or targets drift away from the set zone.

CPA Alarm

The target tracking symbol changes to a triangle when its predicted course (vector) violates the operator set CPA/TCPA. The operator can readily change the vector lengths to evaluate the target movement trend.

Symbols for TT (ARPA)

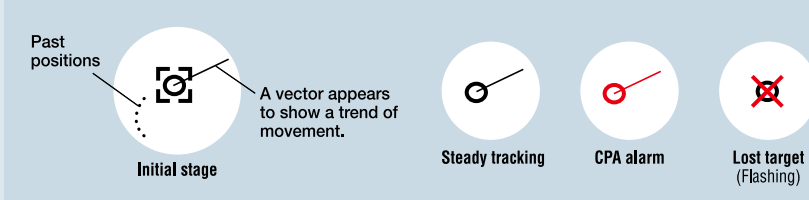

Past Position Display

The ARPA (TT) displays equally time-spaced dots marking the past positions of any targets being tracked. A new dot is added during preset time intervals until the preset number is reached. AIS also displays past position dots.

► **Target Trails**

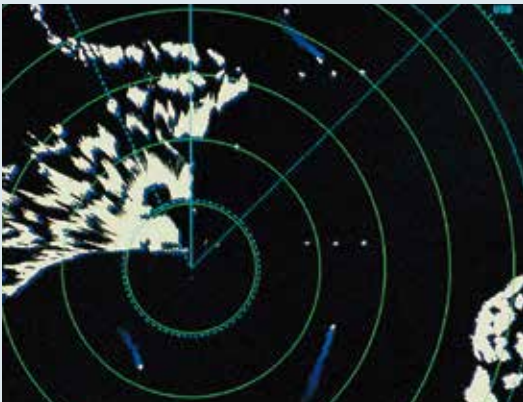

The target trails feature generates a monotone or gradual shading afterglow on all objects on the display. The trails are useful in showing own ship movement and other ship tracks in a specific fishing operation. The unique feature in this radar is a choice of True or Relative mode in Relative Motion (only True in TM). When changing modes, trails remain on the screen.

► **Radar Map**

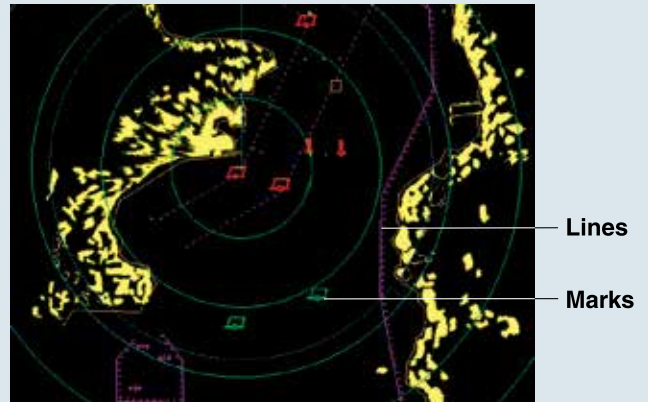

Lines
Marks

A radar map is a combination of lines and marks whereby the user can define and input the navigation area, route planning and monitoring data. The radar map can include up to 20,000 points for lines and marks. The map data can be saved to facilitate repeated use on a routine navigation area. Planned routes created on ECDIS can be transferred onto a radar display when interfaced with ECDIS.

► **Chart Overlay**



This radar incorporates a VideoPlotter that displays electronic charts, plots own and other ship's track, enables entry of waypoints/routes, and makes a radar map. The Radar targets are overlaid on the chart. (For non-SOLAS ships only)

► **Presentation Colors**

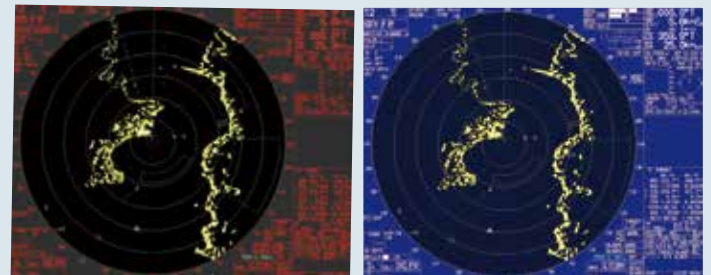

Product Name MARINE RADAR/ARPA**Antenna Radiators****1. Type** Slotted waveguide array**2. Beamwidth and sidelobe attenuation**

Radiator Type	X-Band			S-Band
	XN-12AF	XN-20AF	XN-24AF	SN-36AF
Length	4 ft	6.5 ft	8 ft	12 ft
Beamwidth(H)	1.9	1.23	0.95	1.8
Beamwidth(W)	20	20	20	25
Sidelobe (within 10)	-24 dB	-28 dB	-28 dB	-24 dB
Sidelobe (outside 10)	-30 dB	-32 dB	-32 dB	-30 dB

3. Rotation

X-Band	
Rotation	24 rpm
Gear Box	RSB-096/103
S-Band	
Rotation	21/26 rpm
Gear Box	RSB-098/099/104/105

RF Transceiver**1. Frequency**

X-band: 9410 MHz 30 MHz

S-band: 3050 MHz 30 MHz

2. Output power

	FAR-2817	FAR-2827	FAR-2827W	FAR-2837S	FAR-2837SW
Output Power	12 kW	25 kW	25 kW	30 kW	30 kW
Transceiver	RTR-078	RTR-079	RTR-081	RTR-080	RTR-082

3. Pulselength/PRR

Range scale (nm)	Pulselength (s)	PRR (Hz)
0.125, 0.25	0.07	3000
0.5	0.07, 0.15	3000
0.75, 1.5	0.07, 0.15, 0.3	3000, 1500
3	0.15, 0.3, 0.5, 0.7	3000, 1500, 1000
6	0.3, 0.5, 0.7, 1.2	1500, 1000, 600
12, 24	0.5, 0.7, 1.2	1000, 600
48, 96	1.2	600

4. I.F. 60 MHz, Logarithmic**5. Bandwidth**
Short pulse: 40 MHz
Middle pulse: 10 MHz
Long pulse: 3 MHz**RADAR DISPLAY****1. Display**

23.1" color LCD (UXGA 1600 x 1200 pixels),

470 (H) x 353 (V) mm,

Effective display diameter: 341 mm

Echo Color: Yellow, green or white in 32 levels

2. Range scales and ring intervals (nm)

Range | .125, .25, .5, .75, 1.5, 3, 6, 12, 24, 48, 96

Ring | .025, .05, .1, .25, .25, .5, 1, 2, 4, 8, 16

3. Minimum range

22 m

4. Range discrimination

26 m

5. Range ring accuracyWithin ± 1 % of the current range scale or 10 m, whichever the greater**6. Presentation modes**

Head-up, STAB head-up, North-up, Course-up, True Motion (sea or ground stabilization)

7. Heading information

GPS compass SC-70/130 is recommended heading sensor as a backup for a gyrocompass. Confirm if your Administrations permit its use.

8. Parallel index lines

1, 2, 3 or 6 lines (menu selectable)

9. Radar map

20,000 points to create coastlines, own ship safety contour, isolated underwater dangers, buoys, traffic routing systems, prohibited areas and fairways as required by IMO.

Target Tracking**1. Acquisition**

Auto or manual acquisition: 100 targets in 0.2-24 (32) nm

2. Tracking

Auto tracking on all acquired targets

3. Acquisition zone

0.5 nm width sector, within 3-6 nm, desired bearing

1 nm width sector or polygon, desired range and bearing

4. Past positions

5 or 10 past positions on all targets

5. Collision warning

CPA Limit: 0.1-20 nm, TCPA Limit: 1-60 minutes

6. Trial maneuver

Dynamic or static, with selected delay time.

AIS FUNCTIONS (Data input from AIS is required)**1. Number of Targets**

1,000 targets max.

2. Past Position Plot Intervals

OFF, 30 s, 1-60 minutes

POWER SUPPLY (specify when ordering)**1. Processor Unit**

FAR-2817

100-115 VAC: 2.6 A (3.0 A for HSC), 220-230 VAC: 1.6 A (1.7 A for HSC), 1 ϕ , 50/60 Hz

FAR-2827

100-115 VAC: 3.0 A (3.4 A for HSC), 220-230 VAC: 1.8 A (1.9 A for HSC), 1 ϕ , 50/60 Hz

FAR-2827W

100-115 VAC: 3.2 A, 220-230 VAC: 1.6 A, 1 ϕ , 50/60 Hz

FAR-2837S/2837SW

100-115 VAC: 3.0 A, 220-230 VAC: 1.5 A, 1 ϕ , 50/60 Hz**2. Display Unit**100-230 VAC, 0.9 A, 1 ϕ , 50/60 Hz440 VAC, 1 ϕ , 50/60 Hz with optional transformer RU-1803**3. Antenna Unit**

FAR-2837S/2837SW:

200 VAC, 3.0 A, 3 ϕ , 50 Hz; 220 VAC, 3.0 A (3.5 A for HSC*), 3 ϕ , 60 Hz; 380 VAC, 1.5 A, 3 ϕ , 50 Hz; 440 VAC, 1.5 A (1.7 A for HSC*), 3 ϕ , 60 Hz

* for FAR-2837S only

110 VAC, 3 ϕ , 60 Hz with RU-5693; 220 VAC, 3 ϕ , 50 Hz withRU-6522; 440 VAC, 3 ϕ , 50 Hz with RU-5466-1**EQUIPMENT LIST****Standard**

- Display Unit MU-231
- Processor Unit RPU-013
- Full-keyboard Control Unit RCU-014
Trackball Control Unit RCU-015
(Specify when ordering)
- Antenna Unit with cable (15/30/40/50 m)
- Power Supply Unit PSU-007 for FAR-2837S
- Standard Spare Parts and Installation Materials

Option

- Performance Monitor PM-31 for X-band, PM-51 for S-band
- Remote Control Unit RCU-016
- Gyro Interface GC-10
- DVI-Analog RGB Conversion Kit OP03-180 (SXGA output)
- RGB Connector DSUB-BNC-1 (for VDR)
- Memory Card Interface Unit CU-200
- Transformer RU-1803/5466-1/5693/6522
- Rectifier RU-3424/1746B
- Junction Box RJB-001
- Antenna Cable RW-9600
- Hand Grip FP03-09840
- Bracket FP03-09820
- Switching Hub HUB-100

INTERCONNECTION DIAGRAM

— Option or Shipyard Supply
 - - - - - Power
 Specify power supply when ordering
 *Optional transformer required

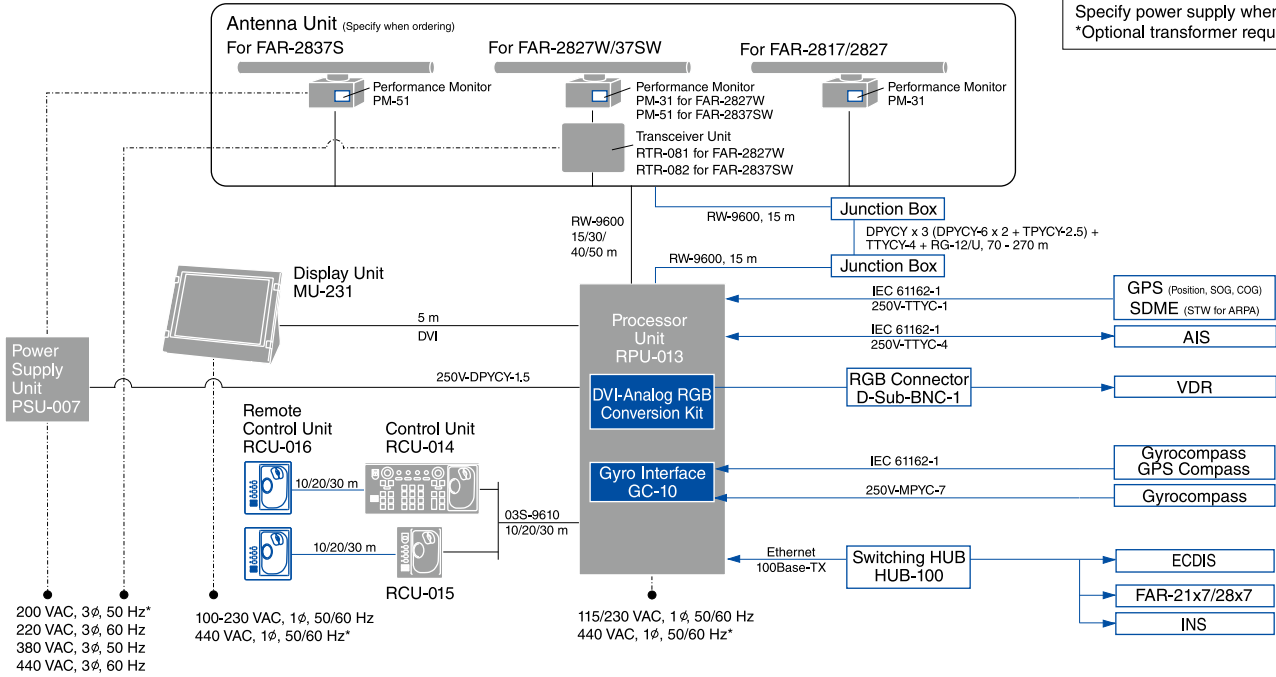

Antenna Unit for FAR-2817/2827/2827W XN-12AF 33 kg 73 lb

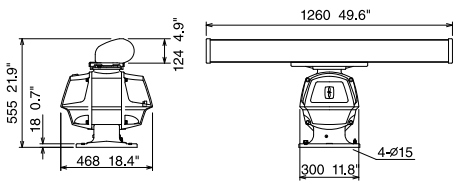

XN-20AF 39 kg 86 lb XN-24AF 42 kg 93 lb

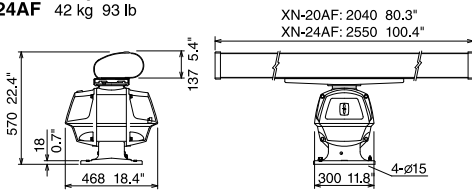

Display Unit MU-231 12.8 kg 28.22 lb

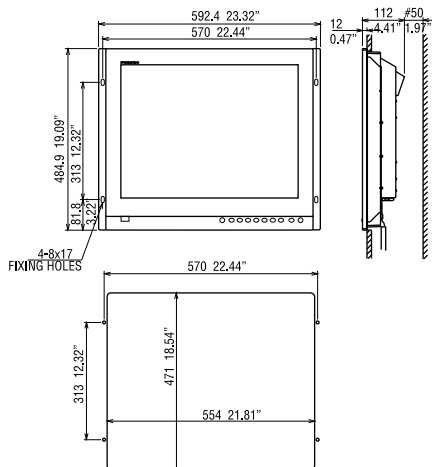

Antenna Unit for FAR-2837S/2837SW SN-36AF 133 kg 293.2 lb

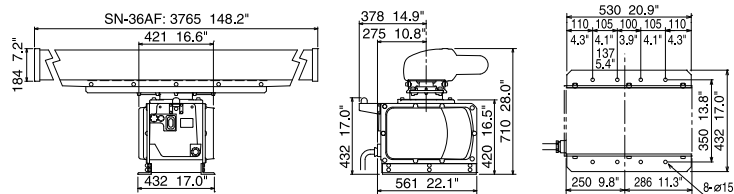

Transceiver Unit for FAR-2827W RTR-081 8.0 kg 17.6 lb

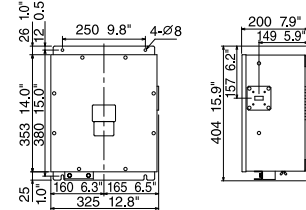

Transceiver Unit for FAR-2837SW RTR-082 17.0 kg 37.5 lb

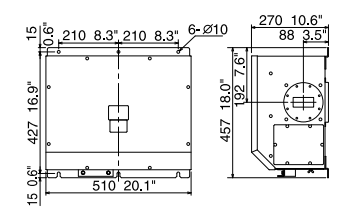

Processor Unit RPU-013 10 kg 22 lb

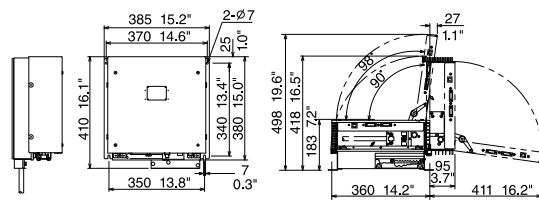

Control Unit Full-keyboard type RCU-014 3.7 kg 8.2 lb

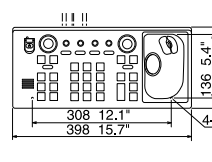

Trackball type RCU-015 2.4 kg 5.3 lb

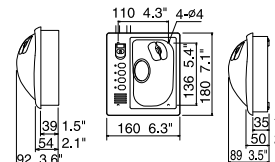

Remote Control Unit RCU-016 2.4 kg 5.3 lb

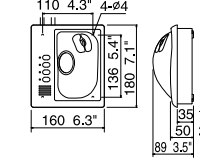

Beware of similar products

All brand and product names are registered trademarks, trademarks or service marks of their respective holders.

SPECIFICATIONS SUBJECT TO CHANGE WITHOUT NOTICE

FURUNO ELECTRIC CO., LTD.
 Japan | www.furuno.com
FURUNO U.S.A., INC.
 U.S.A. | www.furunousa.com
FURUNO PANAMA S.A.
 Republic of Panama | www.furuno.com.pa
FURUNO (UK) LIMITED
 U.K. | www.furuno.co.uk
FURUNO NORGE A/S
 Norway | www.furuno.no

FURUNO DANMARK A/S
 Denmark | www.furuno.dk
FURUNO SVERIGE AB
 Sweden | www.furuno.se
FURUNO FINLAND OY
 Finland | www.furuno.fi
FURUNO POLSKA Sp. Z o.o.
 Poland | www.furuno.pl
FURUNO DEUTSCHLAND GmbH
 Germany | www.furuno.de

FURUNO FRANCE S.A.S.
 France | www.furuno.fr
FURUNO ESPAÑA S.A.
 Spain | www.furuno.es
FURUNO ITALIA S.R.L.
 Italy | www.furuno.it
FURUNO HELLAS S.A.
 Greece | www.furuno.gr
FURUNO (CYPRUS) LTD
 Cyprus | www.furuno.com.cy

FURUNO EURUS LLC
 Russian Federation | www.furuno.ru
FURUNO SHANGHAI CO., LTD.
 China | www.furuno.com/cn
FURUNO CHINA CO., LTD.
 Hong Kong | www.furuno.com/cn
FURUNO KOREA CO., LTD
 Korea
FURUNO SINGAPORE
 Singapore | www.furuno.sg

PT FURUNO ELECTRIC INDONESIA
 Indonesia | www.furuno.id