

SPECIFICATIONS

DISPLAY UNIT	MR-1210RII	MR-1210TII (4 ft model) (6.5 ft model)	MR-1210TIII (4 ft model) (6.5 ft model)
Display type	12.1-inch TFT color LCD		
Resolution	600×800 dots		
Minimum range	25 m (at 1/8 NM range)		
Maximum range	36 NM	48 NM	72 NM
Range scales (NM)	1/8, 1/4, 1/2, 3/4, 1, 1.5, 2, 3, 4, 6, 8, 12, 16, 24, 32, 36, 48*, 64*, 72* (* MR-1210TII/TIII only ** MR-1210TIII only)		
Preheat time	90 seconds		
Power supply	10.2-42 V DC		
Power consumption (at zero wind velocity)	60 W (approx.)	70 W (approx.)	80 W (approx.)
Usable Temp. range	-15°C to +55°C		
Input data format	NMEA 0183, N+1, AUX, IEC61162-2		
Output data format	NMEA 0183		
SCANNER UNIT	MR-1210RII	MR-1210TII	MR-1210TIII
Scanner type	2 ft (60 cm) radome scanner	4 ft (120 cm) open array scanner	6.5 ft (200 cm) open array scanner
Rotation speed	24, 36 rpm typ.	24, 36 rpm typ.	22, 24, 36 rpm typ.
Horizontal beamwidth	4° typ.	2° typ.	1.2° typ.
Vertical beamwidth	22° typ.	23° typ.	23° typ.
Side lobe	-22 dB typ.	-24 dB typ.	-27 dB typ.
Usable Temp. range	-25°C to +70°C		
Usable humidity range	Less than 95% (at 40°C)		
Frequency	9410 MHz ±30 MHz		
Modulation	P0N		
Peak output power	4 kW	4 kW	6 kW
Pulse-width/repetition rate	80 nS/2160 Hz, 80 nS/1440 Hz, 250 nS/1440 Hz, 350 nS/1440 Hz, 900 nS/720 Hz, 900 nS/660 Hz* (* MR-1210TIII only)		
Modulator	FET switching		
Intermediate frequency	60 MHz		
IF bandwidth	10 MHz, 3 MHz		
Tuning	Auto/manual selectable		
Supplied system cable	15 m; 49.2 ft; OPC-2341	20 m; 65.6 ft; OPC-2342	

All stated specifications are subject to change without notice or obligation.

Applicable IP Rating

Ingress Protection Standard

DISPLAY UNIT	IPX4	SCANNER UNIT	IPX6

OPTIONS

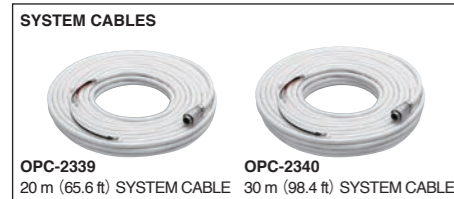

Icom, Icom Inc. and the Icom logo are registered trademarks of Icom Incorporated (Japan) in Japan, the United States, the United Kingdom, Germany, France, Spain, Russia, Australia, New Zealand, and/or other countries.
Credits: This product includes "zlib", "libevent", "libusb" and "freetype" open source software, and is licensed according to the open source software license.

Icom Inc. 1-1-32, Kamiminami, Hirano-Ku, Osaka 547-0003, Japan Phone: +81 (06) 6793 5302 Fax: +81 (06) 6793 0013 www.icom.co.jp/world **Count on us!**

Icom America Inc.
12421 Willows Road NE,
Kirkland, WA 98034, U.S.A.
Phone: +1 (425) 454-8155
Fax: +1 (425) 454-1509
E-mail: sales@icomamerica.com
URL: <http://www.icomamerica.com>

Icom (Europe) GmbH
Communication Equipment
Auf der Krautweide 24
65812 Bad Soden am Taunus, Germany
Phone: +49 (6196) 76685-0
Fax: +49 (6196) 76685-50
E-mail: info@icomeurope.com
URL: <http://www.icomeurope.com>

Icom France s.a.s.
Zac de la Plaine
1 Rue Brindejonc des Moulinais, BP 45804,
31505 Toulouse Cedex 5, France
Phone: +33 (5) 61 36 03 03
Fax: +33 (5) 61 36 03 00
E-mail: icom@icom-france.com
URL: <http://www.icom-france.com>

Icom Canada
Glenwood Centre #150-6165
Highway 17A, Delta, B.C.,
V4K 5B8, Canada
Phone: +1 (604) 952-4266
Fax: +1 (604) 952-0090
E-mail: info@icomcanada.com
URL: <http://www.icomcanada.com>

Icom Spain S.L.
Ctra. Rubi, No. 88 "Edificio Can Castanyer"
Bajos A 08174, Sant Cugat del Valles,
Barcelona, Spain
Phone: +34 (93) 590 26 70
Fax: +34 (93) 589 04 46
E-mail: icom@icomspain.com
URL: <http://www.icomspain.com>

Icom (Australia) Pty. Ltd.
Unit 1 / 103 Garden Road,
Clayton, VIC 3168 Australia
Phone: +61 (03) 9549 7500
Fax: +61 (03) 9549 7505
E-mail: sales@icom.net.au
URL: <http://www.icom.net.au>

Icom Brazil
Rua Itororó, 444 Padre Eustáquio
Belo Horizonte MG,
CEP: 30720-450, Brazil
Phone: +55 (31) 3582 8847
Fax: +55 (31) 3582 8987
E-mail: sales@icombrasil.com

Icom (UK) Ltd.
Blacksole House, Altira Park,
Herne Bay, Kent, CT6 6GZ, U.K.
Phone: +44 (0) 1227 741741
Fax: +44 (0) 1227 741742
E-mail: info@icomuk.co.uk
URL: <http://www.icomuk.co.uk>

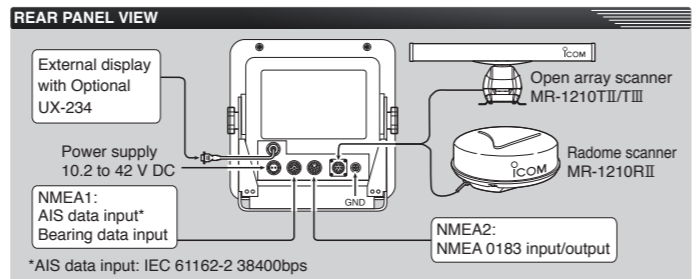
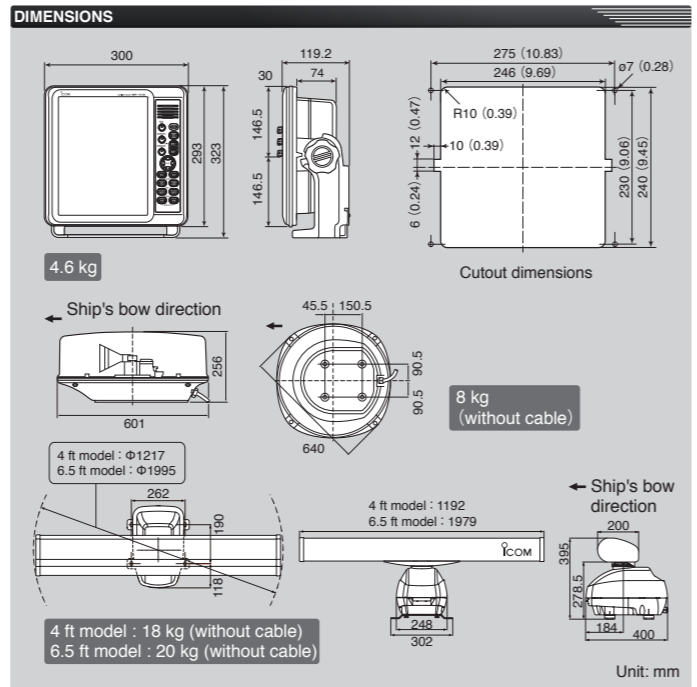

Optional Video Output Unit

With an optional video output unit, UX-234, the MR-1210 can be connected to an external display. Same radar echoes can be observed on the main and secondary displays at the same time.



MR-1210RII

12.1-inch Color TFT, 4 kW Radome Scanner

MR-1210TII

12.1-inch Color TFT, 4 kW Open Array Scanner(4 ft/6.5 ft models)

MR-1210TIII

12.1-inch Color TFT, 6 kW Open Array Scanner(4 ft/6.5 ft models)

- 12.1-inch Large Color TFT Display (600×800 dots)
- 4 kW Radome Radar (MR-1210RII), 4 kW Open Array Scanner (MR-1210TII, 4 ft/6.5 ft models), 6 kW Open Array Scanner (MR-1210TIII, 4 ft/6.5 ft models)
- True Trail Function *1
- AIS Overlay Function*2
- Simplified ATA Function
- New User Interface
- Optional Video Output Unit (*1 External NMEA 0183 data and heading sensor required *2 External AIS data required)



Color Marine Radar with AIS Overlay Functions



MR-1210R II
(2 ft radome model) **4kW Output**
36NM Range



MR-1210T II
(4 ft model / 6.5 ft model) **4kW Output**
48NM Range



MR-1210T III
(4 ft model / 6.5 ft model) **6kW Output**
72NM Range



Stabilized Head Up Mode*

When turning your own boat, the radar echo smoothly follows the boat movement without delay.
*External heading sensor (NMEA 0183, N+1 or other formats) required.

TLL (Target Latitude Longitude) Function*

The MR-1210 can mark points with icons and transfer the position data with NMEA TLL sentences to other NMEA 0183 devices such as an external plotter.
*External NMEA 0183 data and heading sensor required.

True Trail Function*

The true trail function cancels own ship movement and shows true moving objects with trails, while static objects are not trailed. The fine trail function allows you to select trail lines from normal, fine or extra fine trail.
*External NMEA 0183 data and heading sensor required.

Simplified ATA (Automatic Tracking Aid)*

The simplified ATA function allows you to track up to 10 vessels with symbol icons. The CPA (Closest Point of Approach) and TCPA (Time to Closest Point of Approach) limits can be calculated and give an audible warning when any of the target vessels comes within the set range or time.
*External NMEA 0183 data and heading sensor required.

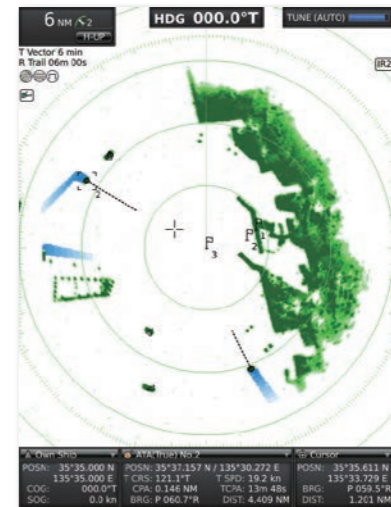

Simplified ATA

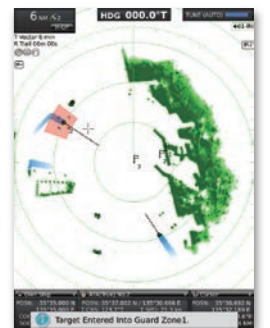

Guard zone alert example

MARINE RADARS MR-1210R II · MR-1210T II / T III

12.1-inch Color TFT Display (600×800 dots)

The 600 cd/m² color TFT offers bright, vivid echoes with 32 steps gradient intensity. The display intensity and display color (day, night and user settings) can be instantly adjusted with the "BRILL" button. The full screen mode enlarges radar echoes to full size with transparent menus and operating information.

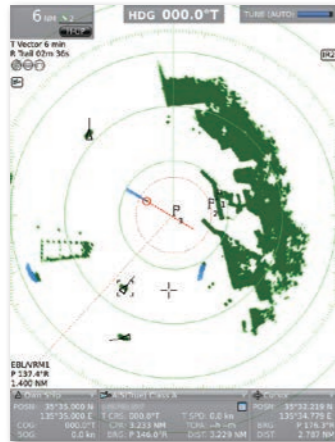

Day setting

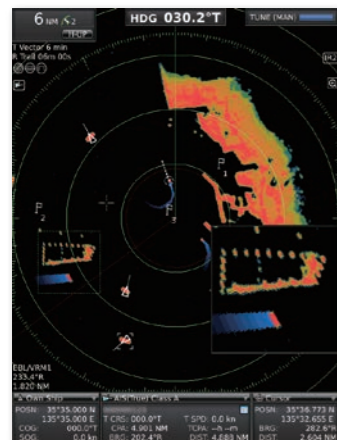

Night setting

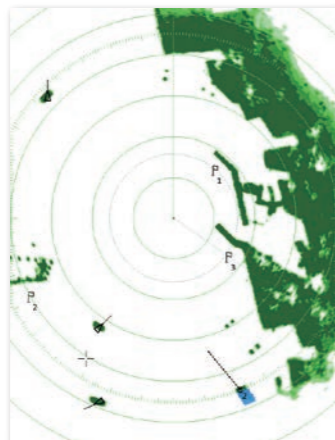

Full screen mode

New User Interface

The MR-1210 provides consistent menu structure and the operator can configure various settings via visually intuitive operation. The language setting is selectable from English, Spanish, Vietnamese, Indonesian, Thai and Korean.

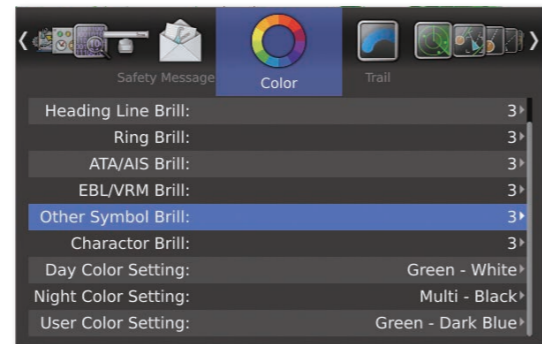

Color setting menu

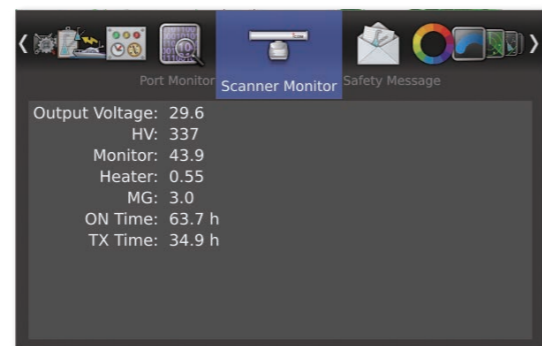

Scanner monitor menu

AIS (Automatic Identification System) overlay function*

When connected to an external AIS receiver or AIS transponder, the MR-1210 overlays the received AIS information on the radar echo. You can see up to 100 AIS targets and check detailed information of the individual vessel such as speed, course, heading, vessel type and size.



Other vessel AIS information



Own vessel information

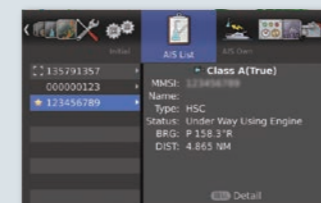

AIS list

Favorite AIS*

The favorite AIS function notifies you when a "friend boat" comes into a preset range. You can easily follow the movement of the boat position on the radar display. Up to three "friends boats" are programmable.
*External AIS data required.

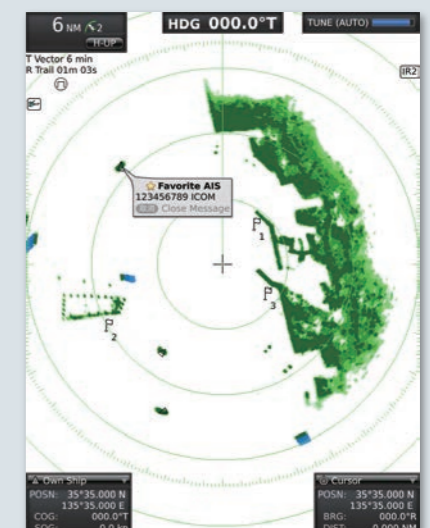

Favorite AIS