

## Nanjing Spare Composite Product Information List

| 工字钢 I-beam   | No. | A     | B/B2      | t     | Serial Number |
|--|-----|-------|-----------|-------|---------------|
|  <p>The diagram shows a cross-section of an I-beam. The total height is labeled 'A'. The top flange width is labeled 'B'. The bottom flange width is labeled 'B2'. The web thickness is labeled 't'. The flanges are shaded with diagonal lines.</p> | 1   | 200   | 200       | 10    | I-0441        |
|  | 2   | 200   | 100/100   | 9.5   | I-0012        |
|  | 3   | 175   | 125/100   | 8     | I-0847        |
|  | 4   | 152.4 | 76.2/76.2 | 9.53  | I-0633        |
|  | 5   | 152.4 | 76.2/76.2 | 6.35  | I-0725        |
|  | 6   | 152   | 80/80     | 10    | I-0016        |
|  | 7   | 139.7 | 63.5      | 6.35  | I-0722        |
|  | 8   | 126   | 90        | 6.5/7 | I-0853        |
|  | 9   | 120   | 120/120   | 8     | I-0329        |
|  | 10  | 120   | 70/70     | 8     | I-0011        |
|  | 11  | 116.5 | 80/80     | 5     | I-0567        |
|  | 12  | 110   | 15        | 5/7   | I-0729        |
|  | 13  | 103   | 100/60    | 6.35  | I-0009        |
|  | 14  | 102   | 51/51     | 6.4   | I-0015        |
|  | 15  | 65    | 30/30     | 3     | I-0017        |
|  | 16  | 58    | 30/30     | 3     | I-0014        |
|  | 17  | 51    | 18/18     | 5     | I-0005        |
|  | 18  | 43    | 86        | 6/4   | I-0521        |
|  | 19  | 40    | 30/30     | 2     | I-0013        |
|  | 20  | 40    | 30/30     | 3     | I-0007        |
|  | 21  | 38    | 15/15     | 4     | I-0001        |
|  | 22  | 25.4  | 15/15     | 4     | I-0002        |
|  | 23  | 25    | 30/30     | 3     | I-0006        |
|  | 24  | 80    | 60/60     | 3.3/4 | I-0617        |
|  |     |       |           |       |               |

| 甲板 deck  | No. | A     | B     | t1/t2     | Serial Number |
|--|-----|-------|-------|-----------|---------------|
|   | 1   | 609.6 | 28.58 | 4.5/4.5   | JB-0634       |
|  | 2   | 540   | 28    | 4         | JB-0830       |
|  | 3   | 500   | 40    | 4/5       | JB-0295       |
|  | 4   | 500   | 40    | 4         | JB-0775       |
|  | 5   | 309   | 26    | 3.5/3.5   | JB-0349       |
|  | 6   | 304.8 | 54.15 | 6.3/6.3   | JB-0296       |
|  | 7   | 304.8 | 54.15 | 5/4.5     | JB-0297       |
|  | 8   | 750   | 3     |           | PB-0308       |
| 整体卫浴甲板   | No. | A     | B     | t1/t2     | Serial Number |
|   | 1   | 500   | 40    | 2.8/4     | JB-0492       |
|  | 2   | 462   | 40    | 3/3       | JB-0486       |
|  | 3   | 450   | 40    | 2.8/4     | JB-0485       |
|  | 4   | 450   | 40    | 2.8/4     | JB-0487       |
|  | 5   | 450   | 40    | 2.8/4     | JB-0488       |
|  | 6   | 148   | 81    | 3/3       | JB-0489       |
| 双孔甲板   | No. | A     | B     | t/t2      | Serial Number |
|  | 1   | 301   | 160   | 8/5 (5.5) | JB-0294-A     |
|  | 2   | 400   | 220   | 11/6.5    | JB-0416       |
|  | 3   | 301   | 160   | 6/4       | JB-0294-B     |
|  |     |       |       |           |               |
|  |     |       |       |           |               |
|  |     |       |       |           |               |
| 角钢 angle   | No. | A     | B     | t         | Serial Number |
|  | 1   | 170   | 80    | 5         | L-0330        |
|  | 2   | 152.4 | 152.4 | 9.52      | L-0803        |

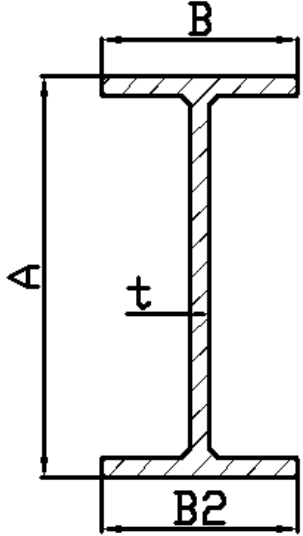
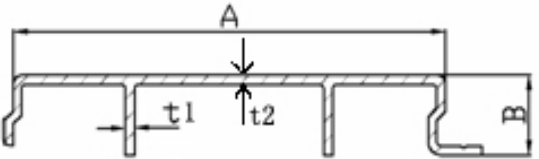
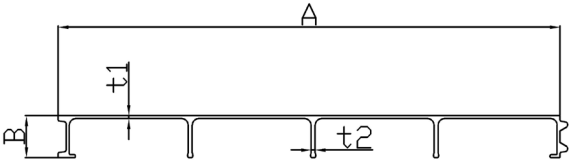
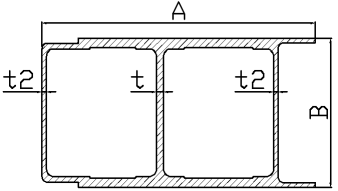
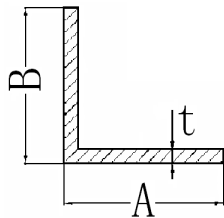

|    |       |       |      |        |
|----|-------|-------|------|--------|
| 3  | 150   | 80    | 3    | L-0641 |
| 4  | 101.6 | 101.6 | 6.35 | L-0637 |
| 5  | 100   | 100   | 8    | L-0035 |
| 6  | 100   | 100   | 6    | L-0562 |
| 8  | 100   | 50    | 8    | L-0019 |
| 9  | 90    | 60    | 5    | L-0028 |
| 10 | 88.9  | 88.9  | 6.35 | L-0653 |
| 11 | 76.2  | 76.2  | 6.35 | L-0022 |
| 12 | 76    | 76    | 9.5  | L-0023 |
| 13 | 75    | 75    | 10   | L-0030 |
| 14 | 75    | 75    | 6    | L-0027 |
| 15 | 70    | 30    | 6.35 | L-0038 |
| 16 | 61.8  | 31.7  | 2.5  | L-0343 |
| 17 | 60.5  | 43.8  | 2.8  | L-0461 |
| 18 | 60    | 40    | 7    | L-0701 |
| 19 | 60    | 60    | 8    | L-0034 |
| 20 | 50.8  | 50.8  | 6.35 | L-0026 |
| 21 | 50    | 50    | 3    | L-0033 |
| 22 | 50    | 50    | 4    | L-0037 |
| 23 | 50    | 35    | 5    | L-0032 |
| 24 | 50    | 50    | 5    | L-0029 |
| 25 | 50    | 50    | 6    | L-0464 |
| 26 | 50    | 48    | 3    | L-0805 |
| 27 | 50    | 38    | 3    | L-0773 |
| 28 | 45    | 45    | 5    | L-0021 |
| 29 | 40    | 40    | 4.2  | L-0025 |
| 30 | 38.1  | 38.1  | 6.35 | L-0652 |
| 31 | 35    | 35    | 5    | L-0020 |
| 32 | 28    | 28    | 3    | L-0036 |
| 33 | 25    | 25    | 3    | L-0031 |

|    |      |      |     |         |
|----|------|------|-----|---------|
| 34 | 50   | 50   | 2.8 | L-0438  |
| 35 | 60   | 40   | 2.8 | L-0421  |
| 36 | 120  | 60   | 2.8 | L-0427  |
| 37 | 100  | 25   | 2.8 | L-0408  |
| 38 | 120  | 100  | 5   | L-0514  |
| 39 | 70.5 | 13.2 | 3.3 | L-0610  |
| 40 | 69.5 | 15   | 5   | TL-0611 |
| 41 | 30   | 36   | 3   | L-0818  |
|    |      |      |     |         |
|    |      |      |     |         |

| 方管 box | No. | A     | t    | Serial Number |
|--------|-----|-------|------|---------------|
|        | 1   | 180   | 15   | F-0857        |
|        | 2   | 101.6 | 9.52 | F-0656        |
|        | 3   | 101.6 | 6.35 | F-0051        |
|        | 4   | 101.6 | 6    | F-0051-6      |
|        | 5   | 100   | 10   | F-0627        |
|        | 6   | 90.6  | 4.3  | F-0463        |
|        | 7   | 90    | 6    | F-0407        |
|        | 8   | 88.9  | 6.35 | F-0654        |
|        | 9   | 88.5  | 12.5 | F-0623        |
|        | 10  | 88.5  | 6.15 | F-0047        |
|        | 11  | 88.5  | 3.1  | F-0519        |
|        | 12  | 82    | 6.35 | F-0415        |
|        | 13  | 82    | 6    | F-0415-6.0    |
|        | 14  | 80    | 3.5  | F-0621        |
|        | 15  | 80    | 12   | F-0546        |
|        | 16  | 76.2  | 9.52 | F-0655        |
|        | 17  | 76.2  | 6.35 | F-0046        |
|        | 18  | 76.2  | 4    | F-0508        |
|        | 19  | 75    | 6    | F-0045        |
|        | 20  | 68    | 5    | F-0748        |
|        | 21  | 64.5  | 3    | F-0054        |
|        | 22  | 63.2  | 5.9  | F-0053        |
|        | 23  | 62.6  | 5.7  | F-0437        |
|        | 24  | 60    | 4.5  | F-0052        |
|        | 25  | 60    | 2.5  | F-0622        |
|        | 26  | 60    | 4.25 | F-0052-4.25   |
|        | 27  | 60    | 4    | F-0783        |
|        | 28  | 58.2  | 3    | F-0055        |
|        | 29  | 50.8  | 6.35 | F-0041-6.35   |

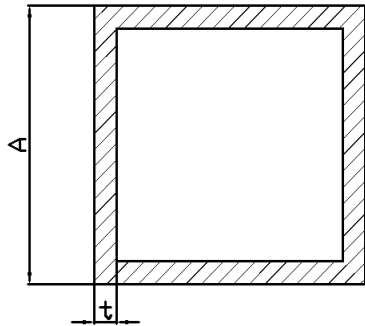



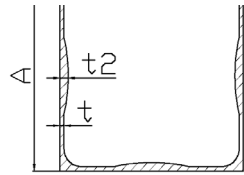

|    |        |           |        |
|----|--------|-----------|--------|
| 5  | 190.5  | 3.18/6.35 | F-0058 |
| 6  | 139.7  | 3.18/6.35 | F-0057 |
| 7  | 142.88 | 3.18/6.35 | F-0382 |
| 8  | 193.68 | 3.18/6.35 | F-0383 |
| 9  | 244.48 | 3.18/6.35 | F-0384 |
| 10 | 295.28 | 3.18/6.35 | F-0385 |

**凹形方管**

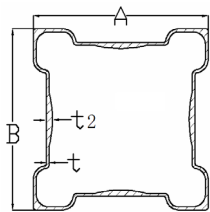

|   | A     | B     | t/t2      | Serial Number |
|---|-------|-------|-----------|---------------|
| 1 | 190.5 | 190.5 | 3.175/6.5 | F-0337        |
|   |       |       |           |               |
|   |       |       |           |               |
|   |       |       |           |               |
|   |       |       |           |               |

**凹角方管**

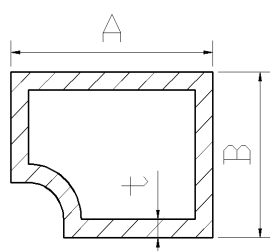

|   | A  | B  | t | Serial Number |
|---|----|----|---|---------------|
| 1 | 23 | 18 | 2 | F-0338        |
|   |    |    |   |               |
|   |    |    |   |               |
|   |    |    |   |               |
|   |    |    |   |               |

**加强方管**

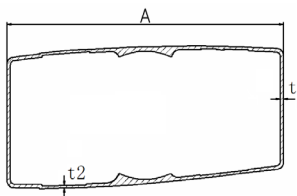

|   | A   | t/t2  | Serial Number |
|---|-----|-------|---------------|
| 1 | 330 | 4/3   | F-0328        |
| 2 | 225 | 3/2.5 | F-0348        |
|   |     |       |               |
|   |     |       |               |
|   |     |       |               |

矩形管 rect tube

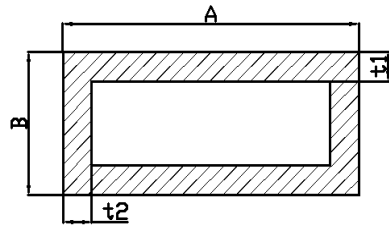

| No. | A        | B        | t1/t2        | Serial Number |
|-----|----------|----------|--------------|---------------|
| 1   | 800      | 300      | 3.5/10       | J-0846        |
| 2   | 190.5    | 45.212   | 2.46         | J-0711        |
| 3   | 160      | 60       | 3.5          | J-0512        |
| 4   | 152.4    | 101.6    | 9.5/9.5      | J-0071        |
| 5   | 140      | 60       | 7            | J-0858        |
| 6   | 130      | 60       | 3.5          | J-0513        |
| 7   | 120      | 90       | 10           | J-0692        |
| 8   | 120      | 60       | 7/7          | J-0483        |
| 9   | 101.6    | 50.8     | 3.125/6.35   | J-0070        |
| 10  | 101.6    | 50.8     | 5/5          | J-0070        |
| 11  | 101.6    | 50.8     | 8.05/8.55    | J-0062        |
| 12  | 100      | 50       | 4            | J-0799        |
| 13  | 95.5     | 45.5     | 4            | J-0069        |
| 14  | 90       | 40       | 4/7          | J-0068        |
| 15  | 75(75.9) | 35(35.3) | 5/5(3.5/5.1) | J-0073        |
| 16  | 75       | 35       | 4.7/7.1      | J-0532        |
| 17  | 65.5     | 30       | 4/5          | J-0065        |
| 18  | 63.5     | 37       | 3.5/3.5      | J-0066        |
| 19  | 60       | 36       | 2/2          | J-0608        |
| 20  | 60       | 20       | 2            | J-0753        |
| 21  | 50.8     | 40.64    | 2.28         | J-0712        |
| 22  | 50.8     | 30       | 3/6.35       | J-0072        |
| 23  | 50       | 30       | 3            | J-0800        |
| 24  | 50       | 25       | 3/3          | J-0368        |
| 25  | 48       | 31       | 4/4          | J-0261        |
| 26  | 40       | 30       | 2.5          | J-0784        |
| 27  | 38       | 15       | 3/3          | J-0263        |
| 28  | 38       | 23.8     | 5/5          | J-0074        |
| 29  | 37       | 20       | 2.5/2.5      | J-0333        |



|    |       |      |                    |        |
|----|-------|------|--------------------|--------|
| 30 | 27.7  | 13.6 | 3/3                | J-0064 |
| 31 | 22    | 20   | 3/3                | J-0511 |
| 32 | 19    | 16   | 2                  | J-0856 |
| 33 | 18.16 | 10.8 | z. z80/z. z80<br>c | J-0063 |
| 34 | 95    | 68   | 6/6                | J-0412 |
| 35 | 120   | 60   | 3                  | J-0451 |
| 36 | 190   | 90   | 4                  | J-0450 |
| 37 | 210   | 110  | 4                  | J-0449 |
| 38 | 80    | 40   | 4                  | J-0618 |
| 39 | 25    | 16   | 2                  | J-0763 |
| 40 | 19    | 16   | 2                  | J-0808 |
|    |       |      |                    |        |
| 33 | 68    | 32   | 3.2/3.6            | J-0264 |
|    |       |      |                    |        |
|    |       |      |                    |        |
|    |       |      |                    |        |
|    |       |      |                    |        |

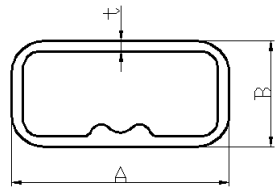

| 槽材 channel | No. | A     | B     | t/t2      | Serial Number |
|------------|-----|-------|-------|-----------|---------------|
|            | 1   | 206   | 272   | 3         | C-0794        |
|            | 1   | 300   | 90    | 15/15     | C-0079        |
|            | 2   | 280   | 70    | 12/12     | C-0094        |
|            | 3   | 254   | 69.85 | 12.7/12.7 | C-0651        |
|            | 4   | 203.2 | 55.56 | 6.35/6.35 | C-0650        |
|            | 5   | 203.2 | 55.56 | 9.52/9.52 | C-0639        |
|            | 6   | 200   | 80    | 4/6       | C-0602        |
|            | 7   | 200   | 60    | 9.5/9.5   | C-0105        |
|            | 8   | 200   | 60    | 8         | C-0419        |
|            | 9   | 193   | 30    | 3/3       | C-0108        |
|            | 10  | 140   | 80    | 14        | C-0777        |
|            | 11  | 140   | 50    | 6/6       | C-0372        |
|            | 12  | 180   | 60    | 8/8       | C-0093        |
|            | 13  | 152.4 | 41.28 | 6.35/6.35 | C-0631        |
|            | 14  | 152.4 | 42.9  | 9.5/9.5   | C-0102        |
|            | 15  | 152.4 | 39.9  | 9.5/9.5   | C-0101        |
|            | 16  | 150   | 75    | 8/6       | C-0466        |
|            | 17  | 150   | 50    | 6/6       | C-0090        |
|            | 18  | 140   | 60    | 2.5       | C-0842        |
|            | 19  | 139.7 | 38.1  | 6.35      | C-0721        |
|            | 20  | 139.7 | 38.1  | 4.76/4.76 | C-0638        |
|            | 21  | 127   | 45    | 6.35/6.35 | C-0100        |
|            | 22  | 120   | 60    | 8/8       | C-0078        |
|            | 23  | 120   | 60    | 5/5.2     | C-0467        |
|            | 24  | 120   | 65    | 10/15     | C-0545        |
|            | 25  | 103   | 60    | 6.35/6.35 | C-0091        |
|            | 26  | 101.6 | 28.6  | 6.35/6.35 | C-0099        |
|            | 27  | 100   | 50    | 10        | C-0696        |

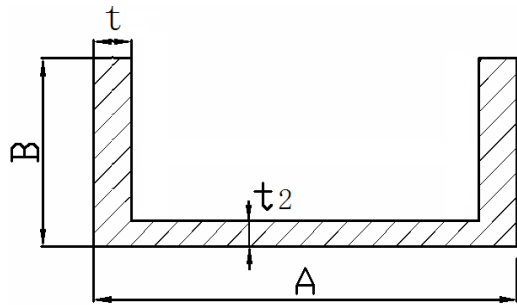

|    |      |       |           |        |
|----|------|-------|-----------|--------|
| 28 | 100  | 50    | 6/6       | C-0089 |
| 29 | 96.5 | 85    | 5/5       | C-0568 |
| 30 | 90   | 45    | 5.2/5.2   | C-0394 |
| 31 | 88.9 | 38.1  | 4.76/4.76 | C-0630 |
| 32 | 87   | 33    | 3.3/3.3   | C-0082 |
| 33 | 85   | 85    | 10        | C-0678 |
| 34 | 85   | 30    | 6/3.65    | C-0334 |
| 35 | 84.5 | 33.3  | 3.3       | C-0083 |
| 36 | 84   | 30    | 5/3.3     | C-0080 |
| 37 | 84   | 30    | 5/3.45    | C-0085 |
| 38 | 84   | 30    | 5/4.3     | C-0086 |
| 39 | 80   | 45    | 3.5/3     | C-0787 |
| 40 | 80.5 | 30    | 3         | C-0768 |
| 41 | 80   | 30    | 3.3/3.3   | C-0314 |
| 42 | 80   | 30    | 3.1/2.6   | C-0389 |
| 43 | 80   | 30    | 3/3       | C-0396 |
| 44 | 76.2 | 25    | 6.35/6.35 | C-0077 |
| 45 | 75   | 35    | 5/5       | C-0454 |
| 46 | 75   | 50/30 | 2.5       | C-0666 |
| 47 | 60   | 60    | 4.8/4.8   | C-0104 |
| 48 | 40   | 60    | 4         | C-0861 |
| 49 | 60   | 35    | 3         | C-0772 |
| 50 | 55   | 70    | 5/5       | C-0084 |
| 51 | 55   | 37    | 4/4       | C-0281 |
| 52 | 50   | 30    | 4/4       | C-0107 |
| 53 | 51   | 25    | 3         | C-0767 |
| 54 | 46   | 40*30 | 3/3       | C-0490 |
| 55 | 44.5 | 31.3  | 3.3       | C-0081 |
| 56 | 44   | 28    | 3.3/2.6   | C-0313 |
| 57 | 44   | 28    | 3.1/2.5   | C-0390 |



| 槽盒 cable tray |  | No. | A   | B   | t/t2    | Serial Number |
|---------------|--|-----|-----|-----|---------|---------------|
|               |  | 1   | 600 | 80  | 4.5/5   | C-0592        |
|               |  | 2   | 600 | 50  | 4.5/5   | C-0431        |
|               |  | 3   | 400 | 80  | 4/5     | C-0420        |
|               |  | 4   | 400 | 50  | 4/5     | C-0432        |
|               |  | 5   | 300 | 50  | 5/4     | C-0155        |
|               |  | 6   | 300 | 50  | 5/3     | C-0169        |
|               |  | 8   | 200 | 50  | 5/3     | C-0154        |
|               |  | 9   | 200 | 50  | 4/3     | C-0165        |
|               |  | 10  | 200 | 80  | 5/3     | C-0164        |
|               |  | 11  | 200 | 50  | 3/3     | C-0352        |
|               |  | 12  | 150 | 50  | 5/3     | C-0153        |
|               |  | 13  | 150 | 50  | 4/3     | C-0157        |
|               |  | 14  | 150 | 80  | 4/3     | C-0158        |
|               |  | 15  | 100 | 50  | 5/3     | C-0152        |
|               |  | 16  | 100 | 50  | 4/3     | C-0156        |
|               |  | 17  | 100 | 80  | 4/3     | C-0160        |
|               |  | 18  | 100 | 50  | 3/3     | C-0350        |
|               |  | 19  | 50  | 50  | 3/3     | C-0163        |
|               |  | 20  | 50  | 80  | 4/3     | C-0162        |
|               |  | 21  | 50  | 50  | 3/3     | C-0161        |
|               |  | 22  | 80  | 80  | 3.2/3.2 | C-0159        |
|               |  | 23  | 200 | 100 | 4.5/3.5 | C-0148        |
|               |  | 24  | 100 | 50  | 3/3     | C-0147        |
|               |  | 25  | 100 | 40  | 4/3     | C-0812        |
|               |  | 26  | 150 | 40  | 4/3     | C-0813        |
|               |  | 27  | 200 | 40  | 4/3     | C-0814        |

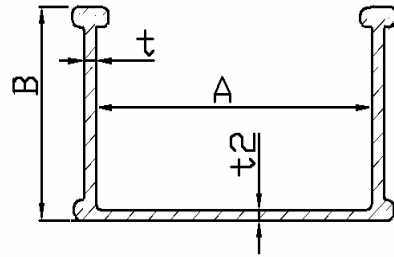

|  |    |     |    |     |        |
|--|----|-----|----|-----|--------|
|  | 28 | 300 | 40 | 5/3 | C-0815 |
|  |    |     |    |     |        |

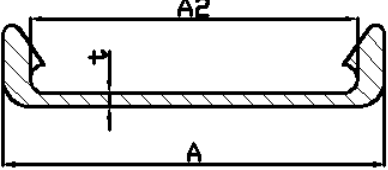
| 槽盖 cover  | No. | A   | A2  | t   | Serial Number |
|---|-----|-----|-----|-----|---------------|
|  | 2   | 236 |     | 3   | C-0172        |
|   | 3   | 220 |     | 3   | C-0353        |
|   | 4   | 184 |     | 3   | C-0341        |
|   | 5   | 120 |     | 3   | C-0351        |
|   | 6   | 96  |     | 3.2 | C-0170        |
|   | 7   | 84  |     | 3   | C-0173        |
|   | 8   | 134 |     | 3   | C-0174        |
|   | 9   |     | 100 | 4   | C-0175        |
|   | 10  |     | 200 | 4.5 | C-0176        |
|   | 11  |     | 300 | 5   | C-0177        |

| 圆管 round tube | No. | A       | t    | Serial Number |
|---------------|-----|---------|------|---------------|
|               | 1   | 244.475 | 3.24 | G-0715        |
|               | 2   | 193.675 | 3.24 | G-0713        |
|               | 3   | 168     | 6    | G-0506        |
|               | 4   | 155     | 6    | G-0505        |
|               | 5   | 152     | 4    | G-0529        |
|               | 6   | 130     | 6    | G-0504        |
|               | 7   | 123     | 6    | G-0503        |
|               | 8   | 117     | 6    | G-0502        |
|               |     | 106     | 3.5  | G-0126        |
|               | 9   | 104     | 6    | G-0501        |
|               | 10  | 98      | 6    | G-0500        |
|               | 11  | 92      | 8    | G-0517        |
|               | 12  | 92      | 6    | G-0499        |
|               | 13  | 85      | 6    | G-0498        |
|               | 14  | 82      | 3    | G-0587        |
|               | 15  | 79      | 6    | G-0497        |
|               | 16  | 76      | 6    | G-0124        |
|               | 17  | 76      | 4    | G-0125        |
|               | 18  | 73      | 5    | G-0123        |
|               | 19  | 71      | 3.5  | G-0122        |
|               | 20  | 60.33   | 4.7  | G-0462        |
|               | 21  | 60      | 3.5  | G-0121        |
|               | 22  | 60      | 2.63 | G-0146        |
|               | 23  | 51.6    | 2.55 | TX-0199       |
|               | 24  | 50      | 5    | G-0585        |
|               | 25  | 50      | 2.6  | G-0750        |
|               | 26  | 50      | 2.6  | G-0751        |
|               | 27  | 50      | 3.5  | G-0752        |
|               | 28  | 50      | 2.8  | G-0413        |



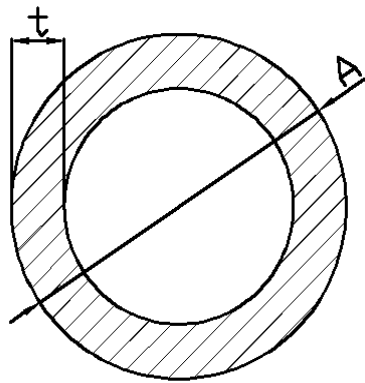

|    |         |      |            |
|----|---------|------|------------|
| 29 | 50      | 2    | G-0586     |
| 31 | 48.5    | 6.75 | G-0410     |
| 32 | 48.5    | 2.5  | G-0439     |
| 33 | 44      | 2.65 | G-0588     |
| 34 | 40      | 4    |            |
| 35 | 40      | 2    | G-0584     |
| 36 | 39.7    | 2.45 | G-0831     |
| ~  | 39.7    | 3.2  | G-0340     |
| 37 | 38.35   | 4.83 | G-0680     |
| 38 | 38      | 5    | G-0120     |
| 39 | 38.1    | 4.7  | G-0522     |
| 40 | 38      | 2.45 | G-0620     |
| 41 | 38      | 3    | G-0132     |
| 42 | 36      | 5    |            |
| 43 | 36      | 2.2  | G-0460     |
| 44 | 36      | 3    | G-0311     |
| 45 | 32.14   | 3.5  | G-0764     |
| 46 | 31.5    | 3.18 | G-0315     |
| 47 | 31.5    | 2.54 | G-0315-2.5 |
| 48 | 31.5    | 2.25 | G-0469     |
| 49 | 32/34.5 | 3.25 | G-0138     |
| 50 | 32      | 4.8  | G-0119     |
| 51 | 32      | 3    | G-0130     |
| 52 | 32      | 2    | G-0117     |
| 53 | 32      | 2.5  | G-0118     |
| 54 | 30.3    | 2.5  | G-0375     |
| 55 | 30      | 4.8  | G-0131     |
| 56 | 30      | 2    | G-0116     |
| 57 | 30      | 2.5  | G-0342     |
| 58 | 28      | 3    | G-0115     |

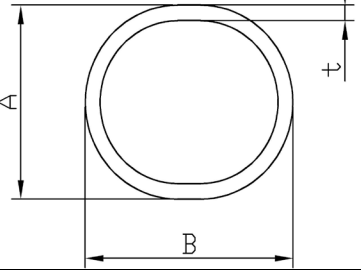
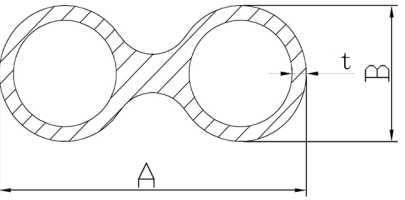
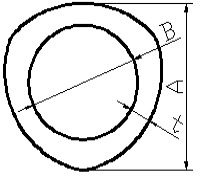

|   |   |       |       |      |               |
|---|---|-------|-------|------|---------------|
|  | 2 | 23.01 | 19.84 | 5.06 | G-0507        |
| <b>双管 Double tube</b>   |   | A     | B     | t    | Serial Number |
|  | 1 | 66.5  | 28.5  | 3.1  | G-0434        |
| <b>三角管</b>  |   | A     | B     | t    | Serial Number |
|  | 1 | 29.7  | 20.32 | 3.94 | G-0373        |
|   |   |       |       |      |               |
|   |   |       |       |      |               |
|   |   |       |       |      |               |
|   |   |       |       |      |               |
|   |   |       |       |      |               |

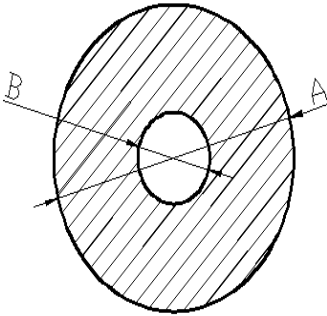
| 纤维杆 tent poles  | No. | A    | B   | Serial Number |
|---|-----|------|-----|---------------|
|  | 1   | 12.7 | 4.0 | XW-0231-4.0   |
|   | 2   | 12.7 | 4.5 | XW-0231-4.5   |
|   | 3   | 12.7 | 5.0 | XW-0231-5.0   |
|   | 4   | 12.7 | 9.0 | XW-0231-9.0   |
|   | 5   | 9.5  | 3.0 | B-0219-3.0    |
|   | 6   | 8.5  | 3.2 | XW-0235-3.2   |
|   | 7   | 8.5  | 3.5 | XW-0235-3.5   |
|   | 8   | 8.5  | 3.8 | XW-0235-3.8   |
|   | 9   | 8.5  | 5.0 | XW-0235-5.0   |
|   | 10  | 7.9  | 3.2 | XW-0232       |
|   | 11  | 7.9  | 3.5 | XW-0233       |
|   | 12  | 7.9  | 4   | XW-0234       |
|   | 13  | 7    | 3.2 | B-0216-3.2    |
|   | 14  | 7    | 3.5 | B-0216-3.5    |
|   | 15  | 6    | 3.0 | XW-0230-3.0   |
|   | 16  | 6    | 3.2 | XW-0230-3.2   |
|   | 17  | 14   | 9.0 | B-0227-9.0    |
|   | 18  | 11   | 4.0 | B-0221-4.0    |
|   | 19  |      |     |               |
|   | 20  |      |     |               |
|   | 21  |      |     |               |

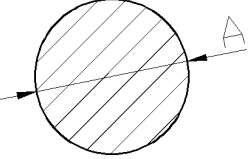
| 圆棒 rod  | No. | A     | Serial Number |
|---|-----|-------|---------------|
|  | 1   | 38    | B-0224        |
|   | 2   | 32    | B-0223        |
|   | 3   | 28    | B-0115        |
|   | 4   | 25.4  | B-0211        |
|   | 5   | 25    | B-0374        |
|   | 6   | 24    | B-0210        |
|   | 7   | 23.7  | B-0209        |
|   | 8   | 22    | B-0208        |
|   | 9   | 20    | B-0207        |
|   | 10  | 18    | B-0206        |
|   | 11  | 16    | B-0228        |
|   | 12  | 16/8  | B-0675        |
|   | 13  | 16/12 | B-0675        |
|   | 14  | 14    | B-0227        |
|   | 15  | 12.7  | B-0222        |
|   | 16  | 12.5  | B-0226        |
|   | 17  | 12    | B-0225        |
|   | 18  | 11    | B-0221        |
|   | 19  | 9.5   | B-0219        |
|   | 20  | 9     | B-0797        |
|   | 21  | 8.5   | B-0218        |
|   | 22  | 7.9   | B-0217        |
|   | 23  | 7     | B-0216        |
|   | 24  | 6.32  | B-0215        |
|   | 25  | 6     | B-0214        |
|   | 26  | 5     | B-0213        |
|   | 27  | 4     | B-0212        |
|   |     |       |               |

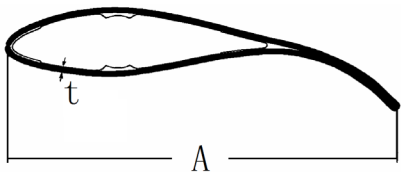
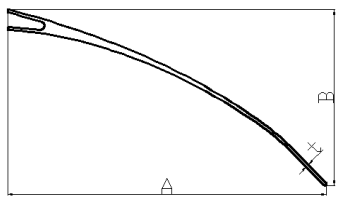
| 叶片blade   |     | No.   | A       | t       | Serial Number |
|---|-----|-------|---------|---------|---------------|
|  | 1   | 900   | 3.2     | YP-0452 |               |
|   | 2   | 610   | 3.5     | YP-0458 |               |
|   | 3   | 610   | 4       | YP-0256 |               |
|   |     | 590   | 3       | YP-0720 |               |
|   |     | 540   | 4.5     | YP-0694 |               |
|   | 4   | 533   | 3       | YP-0493 |               |
|   | 5   | 371   | 3       | YP-0443 |               |
|   | 6   | 355   | 2.5     | YP-0258 |               |
| 7   | 270 | 3.0   | YP-0740 |         |               |
|  |     | A     | B       | t       | Serial Number |
|   | 1   | 533   | 284.9   | 5       | YP-0339       |
|   |     |       |         |         |               |
|   |     |       |         |         |               |
|   |     |       |         |         |               |
| 扁条 flat   |     | No.   | A       | t       | Serial Number |
|   | 1   | 200   | 9.5     | BT-0642 |               |
|   | 2   | 136   | 6.35    | BT-0236 |               |
|   | 3   | 110   | 4       | BT-0859 |               |
|   | 4   | 101.6 | 12.7    | BT-0635 |               |
|   | 5   | 101.6 | 6.35    | BT-0636 |               |
|   | 6   | 100   | 2.8     | BT-0583 |               |
|   | 7   | 87.9  | 5       | BT-0245 |               |
|   | 8   | 80    | 8       | BT-0244 |               |
|   | 9   | 76.2  | 12.7    | BT-0629 |               |
|   | 10  | 76.2  | 6.35    | BT-0806 |               |
|   | 11  | 76    | 22      | BT-0241 |               |
|   | 12  | 60    | 3       | BT-0246 |               |
|   | 13  | 50    | 4       | BT-0247 |               |

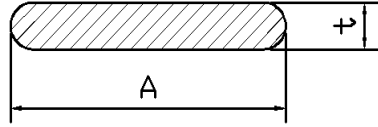

|    |       |     |         |
|----|-------|-----|---------|
| 14 | 40    | 8   | BT-0832 |
| 15 | 40    | 5   | BT-0242 |
| 16 | 40    | 3   | BT-0475 |
| 17 | 40    | 4   | BT-0249 |
| 18 | 39    | 13  | BT-0801 |
| 19 | 38.5  | 13  | BT-0358 |
| 20 | 32    | 6   | BT-0471 |
| 21 | 32    | 3   | BT-0251 |
| 22 | 30    | 4   | BT-0474 |
| 23 | 30    | 3   | BT-0798 |
| 24 | 28.58 | 3   | BT-0312 |
| 25 | 23    | 2   | BT-0359 |
| 26 | 20    | 4   | BT-0254 |
| 27 | 20    | 6   | BT-0253 |
| 28 | 16    | 6   | BT-0553 |
| 29 | 16    | 2   | BT-0250 |
| 30 | 15    | 4.5 | BT-0473 |
| 31 | 15    | 2.5 | BT-0252 |
| 32 | 15    | 4   | BT-0238 |
| 33 | 9     | 2.5 | BT-0248 |
| 34 | 53    | 2.5 | BT-0523 |
| 35 | 50    | 3.2 | BT-0738 |

平板 panel

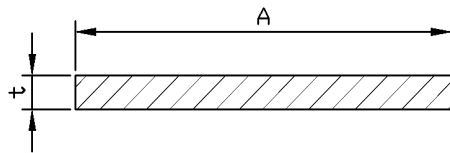

|   | A   | B | Serial Number |
|---|-----|---|---------------|
| 1 | 598 | 3 | PB-0793       |
| 2 | 582 | 4 | PB-0309       |
| 3 | 500 | 6 | PB-0578       |
| 4 | 270 | 8 | PB-0779       |
|   |     |   |               |
|   |     |   |               |

太阳能边框 solar bezel

| No. | A | B | t/t2 | Serial Number |
|-----|---|---|------|---------------|
|-----|---|---|------|---------------|

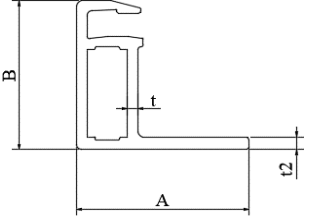
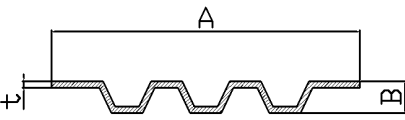
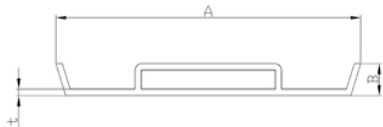
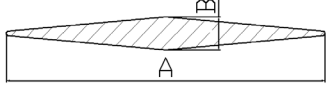
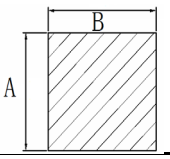
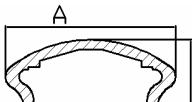
|   |   |     |      |       |         |
|---|---|-----|------|-------|---------|
|    | 1 | 33  | 30   | 2/2.5 | BK-0840 |
|   | 2 | 33  | 30   | 2/2.5 | BK-0845 |
| <b>踢脚板 kick plate</b>   |   |     |      |       |         |
|    | 1 | 150 | 15   | 3     | TJ-0306 |
|   | 2 | 110 | 18.5 | 3.5   | TJ-0300 |
|   | 3 | 150 | 15   | 5     | TJ-0496 |
| <b>踢脚板 kick plate</b>   |   |     |      |       |         |
|    | 1 | 150 | 15   | 3     | TJ-0305 |
|   |   |     |      |       |         |
| <b>菱形条 diamond flat</b>   |   |     |      |       |         |
|   | 1 | 24  | 4    |       | LX-0269 |
|   |   |     |      |       |         |
| <b>方棒 square rod</b>  |   |     |      |       |         |
|  | 1 | 25  | 10   |       | JB-0362 |
|   | 2 | 10  | 11   |       | FB-0361 |
|   | 3 | 6.4 | 6.4  |       | FB-0270 |
|   | 4 | 10  | 10   |       | FB-0484 |
| <b>扶手 handrail</b>  |   |     |      |       |         |
|  | 1 | 75  | 60   | 4.5   | FS-0271 |
|   |   |     |      |       |         |



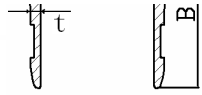

空腹大板 splank

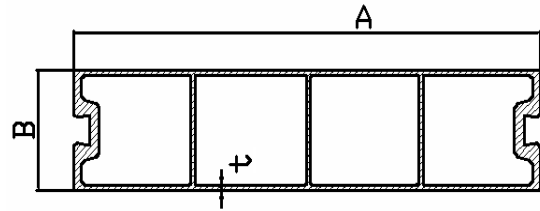

| No. | A   | B  | t       | Serial Number |
|-----|-----|----|---------|---------------|
| 1   | 634 | 60 | 3.2/3.5 | KF-0665       |
| 2   | 600 | 80 | 4/3.5   | KF-0590       |
| 3   | 600 | 60 | 3.2/3.5 | KF-0664       |
| 4   | 317 | 60 | 3.2/3.5 | KF-0704       |
| 5   | 300 | 60 | 2.8/3.5 | KF-0705       |
| 6   | 617 | 60 | 3.2/3.5 | KF-0706       |
| 7   | 600 | 60 | 2.8/3.5 | KF-0707       |
| 8   | 140 | 20 | 2.5     | KF-0790       |

空腹板

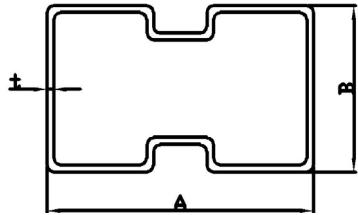

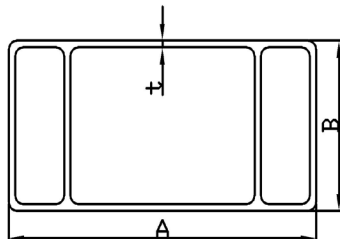

| No. | A   | B   | t | Serial Number |
|-----|-----|-----|---|---------------|
| 1   | 270 | 200 | 5 | KX-0447       |
| 2   | 200 | 120 | 5 | KX-0446       |

空腹板

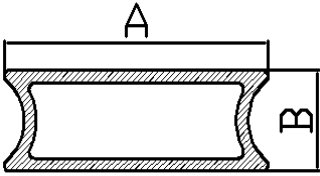
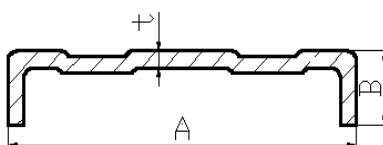
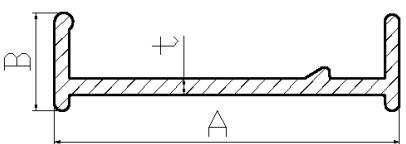
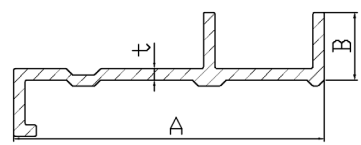

| No. | A      | B      | t     | Serial Number |
|-----|--------|--------|-------|---------------|
| 1   | 1000   | 90     | 4     | KX-0510       |
| 2   | 491    | 49.1   | 5/3.8 | KF-0645       |
| 3   | 241    | 49.1   | 5/3.8 | KF-0669       |
| 4   | 227.25 | 210    | 3.2   | KF-0757       |
| 5   | 150    | 149.28 | 3.2   | KF-0758       |
| 6   | 200    | 100    | 4     | KX-0445       |
| 7   | 190    | 38     | 3     | KX-0481       |
| 8   | 180    | 80     | 4     | KX-0448       |

|   |    |            |          |          |          |                      |
|---|----|------------|----------|----------|----------|----------------------|
|   |    | 9          | 170.5    | 49.1     | 3.8      | KF-0644              |
|   |    | 10         | 170.5    | 49.1     | 3.8      | KF-0668              |
|   |    | 11         | 116      | 49.1     | 3.8      | KF-0667              |
|   |    | 12         | 116      | 49.1     | 3.8/5    | KF-0670              |
| <b>中腿 center leg</b>  |    |            | <b>A</b> | <b>B</b> |          | <b>Serial Number</b> |
|    | 1  | 66         | 23.5     |          | ZT-0325  |                      |
|   |    |            |          |          |          |                      |
|   |    |            |          |          |          |                      |
|   |    |            |          |          |          |                      |
| <b>桥帮 cable ladder rail</b>   |    | <b>No.</b> | <b>A</b> | <b>B</b> | <b>t</b> | <b>Serial Number</b> |
|    | 1  | 200        | 25       | 5.5      | Q-0185   |                      |
|   | 2  | 100        | 25       | 4.5      | Q-0182   |                      |
|    | 4  | 150        | 42       | 4        | Q-0187   |                      |
|   | 5  | 150        | 42       | 7        | Q-0186   |                      |
|   | 6  | 100        | 37       | 4        | Q-0183   |                      |
|   | 7  | 75         | 32       | 6        | Q-0179   |                      |
|   | 8  | 70         | 18       | 4        | Q-0331   |                      |
|   | 9  | 150        | 30       | 5        | Q-0181   |                      |
|  | 10 | 135        | 30       | 5        | Q-0180   |                      |
|   |    |            |          |          |          |                      |
| <b>其他产品</b>   |    |            |          |          |          |                      |
| <b>天线罩 radome</b>   |    | <b>No.</b> | <b>A</b> | <b>B</b> | <b>t</b> | <b>Serial Number</b> |
|  | 1  | 289        | 85       | 2.5      | TX-0201  |                      |
|   | 2  | 340        | 230      | 2.8      | TX-0194  |                      |

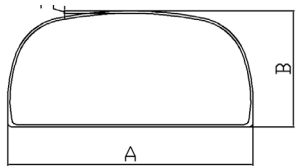

|   |     |       |     |         |
|---|-----|-------|-----|---------|
| 3 | 264 | 99.71 | 2.8 | TX-0195 |
| 4 | 262 | 118   | 2.8 | TX-0189 |
| 5 | 262 | 120   | 2.5 | TX-0196 |
| 8 | 157 | 95.5  | 2.5 | TX-0197 |
| 9 | 152 | 49.3  | 2.8 | TX-0190 |

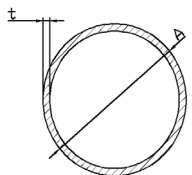

|    |     |  |     |         |
|----|-----|--|-----|---------|
| 10 | 280 |  | 2.8 | TX-0198 |
|    |     |  |     |         |
|    |     |  |     |         |
|    |     |  |     |         |
|    |     |  |     |         |

梯形管 trapezoid tube

| No. | A   | B/B2    | t   | Serial Number |
|-----|-----|---------|-----|---------------|
| 1   | 140 | 41.2/61 | 3.5 | TX-0657       |
| 2   | 76  | 158/9.9 | 3.5 | TX-0658       |
|     |     |         |     |               |
|     |     |         |     |               |
|     |     |         |     |               |

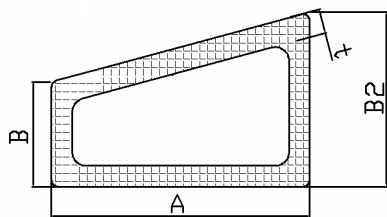

山字型 E-snape

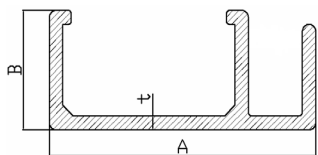

| No. | A   | B  | t | Serial Number |
|-----|-----|----|---|---------------|
| 1   | 144 | 30 | 5 | S-0356        |
|     |     |    |   |               |
|     |     |    |   |               |
|     |     |    |   |               |
|     |     |    |   |               |

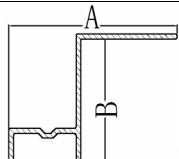

门框 doorframe

| No. | A   | B   |  | Serial Number |
|-----|-----|-----|--|---------------|
| 1   | 100 | 80  |  | MK-0290       |
| 2   | 100 | 100 |  | MK-0418       |
|     |     |     |  |               |
|     |     |     |  |               |

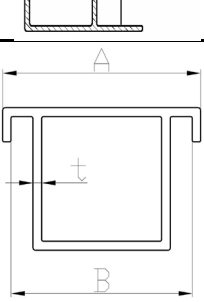
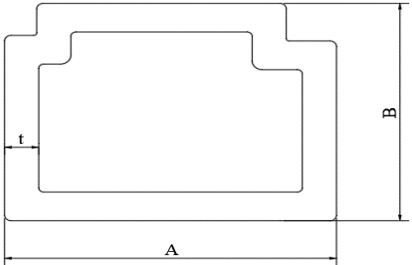
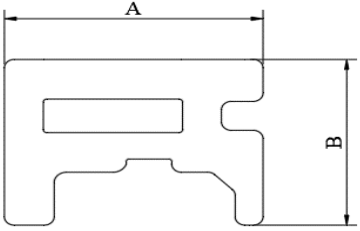

|   |     |         |         |          |                          |
|---|-----|---------|---------|----------|--------------------------|
|    | 3   | A<br>72 | B<br>66 | t<br>3.2 | Serial Number<br>MK-0435 |
| 门框型材  | No. | A       | B       | t        | Serial Number            |
|    | 1   | 49.6    | 38.7    | 5.11     | MK-0769                  |
|   | 1   | 33.02   | 25.07   |          | MK-0770                  |
|  | 1   | 39.1    | 44.9    |          | YX-0774                  |

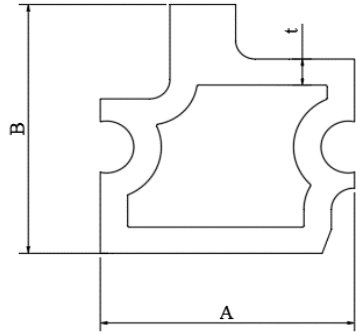
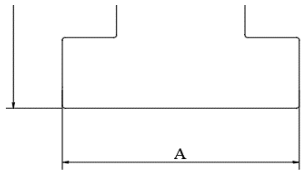

|  |  |  |  |  |
|--|--|--|--|--|
|  |  |  |  |  |
|  |  |  |  |  |
|  |  |  |  |  |
|  |  |  |  |  |
|  |  |  |  |  |

| No. | A  | B     | t | Serial Number |
|-----|----|-------|---|---------------|
| 1   | 37 | 38.18 | 4 | MK-0795       |
|     |    |       |   |               |
|     |    |       |   |               |
|     |    |       |   |               |
|     |    |       |   |               |
|     |    |       |   |               |
|     |    |       |   |               |
|     |    |       |   |               |
|     |    |       |   |               |
|     |    |       |   |               |
|     |    |       |   |               |

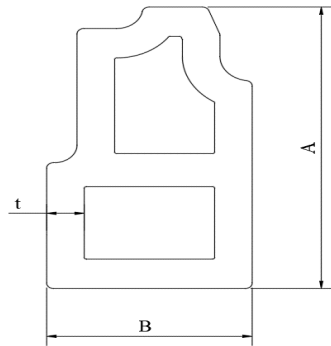

| No. | A     | B     | t | Serial Number |
|-----|-------|-------|---|---------------|
| 1   | 38.29 | 21.87 | 4 | MK-0796       |
|     |       |       |   |               |
|     |       |       |   |               |
|     |       |       |   |               |
|     |       |       |   |               |
|     |       |       |   |               |
|     |       |       |   |               |
|     |       |       |   |               |
|     |       |       |   |               |
|     |       |       |   |               |
|     |       |       |   |               |

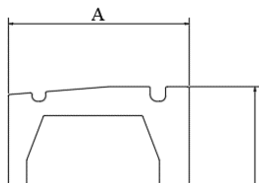

| No. | A    | B     | t | Serial Number |
|-----|------|-------|---|---------------|
| 1   | 40.7 | 48.11 |   | MK-0802       |
|     |      |       |   |               |
|     |      |       |   |               |
|     |      |       |   |               |
|     |      |       |   |               |

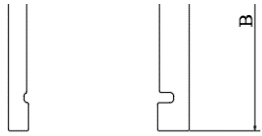

|  |  |  |  |  |
|--|--|--|--|--|
|  |  |  |  |  |
|  |  |  |  |  |
|  |  |  |  |  |
|  |  |  |  |  |

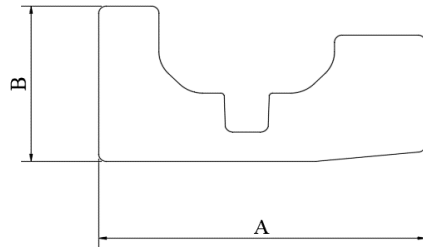

| No. | A    | B     | t | Serial Number |
|-----|------|-------|---|---------------|
| 1   | 42.4 | 21.42 |   | MK-0807       |
|     |      |       |   |               |
|     |      |       |   |               |
|     |      |       |   |               |
|     |      |       |   |               |
|     |      |       |   |               |
|     |      |       |   |               |
|     |      |       |   |               |
|     |      |       |   |               |
|     |      |       |   |               |

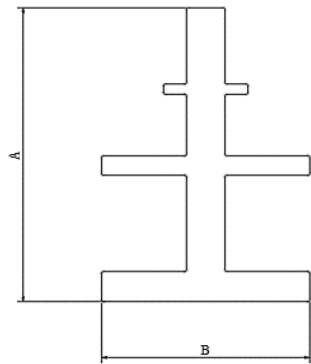

| No. | A    | B  | t | Serial Number |
|-----|------|----|---|---------------|
| 1   | 64.2 | 43 |   | MK-0809       |
|     |      |    |   |               |
|     |      |    |   |               |
|     |      |    |   |               |
|     |      |    |   |               |
|     |      |    |   |               |
|     |      |    |   |               |
|     |      |    |   |               |
|     |      |    |   |               |
|     |      |    |   |               |

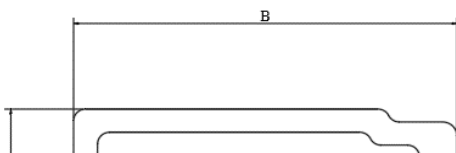

| No. | A     | B     | t | Serial Number |
|-----|-------|-------|---|---------------|
| 1   | 26.63 | 79.69 |   | MK-0810       |
|     |       |       |   |               |
|     |       |       |   |               |
|     |       |       |   |               |

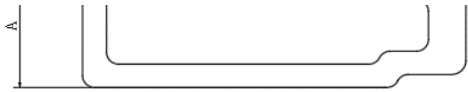

| 门边条 door edge strip  |   | No.   | A  | B   | t | Serial Number |
|----------------------|---|-------|----|-----|---|---------------|
|                      | 1 | 10    | 25 |     |   | MK-0756       |
|                      |   |       |    |     |   |               |
|                      |   |       |    |     |   |               |
|                      |   |       |    |     |   |               |
|                      |   |       |    |     |   |               |
|                      |   |       |    |     |   |               |
|                      |   |       |    |     |   |               |
|                      |   |       |    |     |   |               |
|                      |   |       |    |     |   |               |
|                      |   |       |    |     |   |               |
| 门框条 door frame strip |   | No.   | A  | B   | t | Serial Number |
|                      |   | 25    | 45 | 3.5 |   | MK-0755       |
|                      |   |       |    |     |   |               |
|                      |   |       |    |     |   |               |
|                      |   |       |    |     |   |               |
|                      |   |       |    |     |   |               |
|                      |   |       |    |     |   |               |
|                      |   |       |    |     |   |               |
|                      |   |       |    |     |   |               |
|                      |   |       |    |     |   |               |
|                      |   |       |    |     |   |               |
| 门板箱体 door panel box  |   | No.   | A  | B   | t | Serial Number |
|                      |   | 288.6 | 25 | 4   |   | MB-0788       |
|                      |   |       |    |     |   |               |

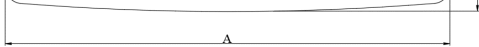
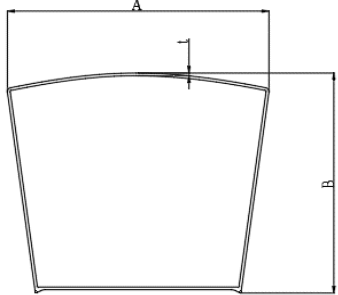
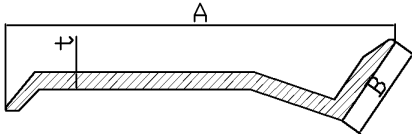
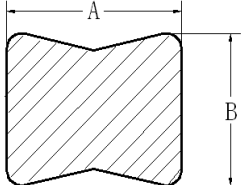
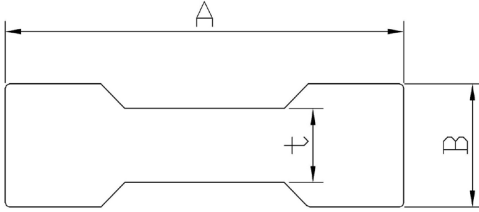
|   |            |          |          |          |                      |
|---|------------|----------|----------|----------|----------------------|
|    |            |          |          |          |                      |
|    |            | 368.7    | 323      | 4        | XT-0789              |
| <b>钩状型材 "7" section profile</b>   | <b>32</b>  | <b>A</b> | <b>B</b> | <b>t</b> | <b>Serial Number</b> |
|    | 1          | 139.15   | 29       | 5        | GZ-0284              |
| <b>连接件 connector</b>  | <b>No.</b> | <b>A</b> | <b>B</b> | <b>t</b> | <b>Serial Number</b> |
|   | 1          | 23       | 19.5     |          | LJ-0397              |
|  | 2          | 50       | 15       | 9        | I-0386               |

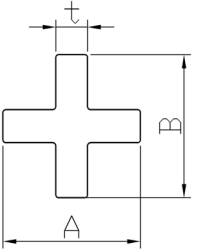
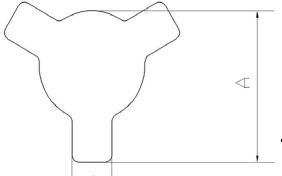
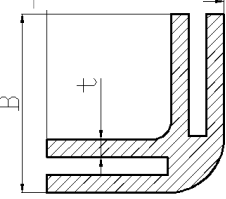
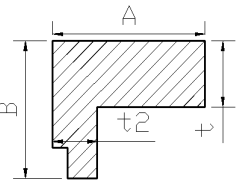
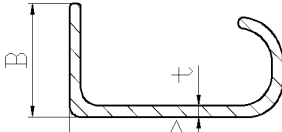

|   |            |          |          |          |                      |
|---|------------|----------|----------|----------|----------------------|
|    | <b>No.</b> | <b>A</b> | <b>B</b> | <b>t</b> | <b>Serial Number</b> |
|   | 1          | 26       | 26       | 6        | LJ-0426              |
|   | 2          | 16       | 16       | 4        | LJ-0478              |
|   | 3          | 14       | 14       | 3.5      | LJ-0693              |
|    | 4          | 11       |          | 3        | LJ-0491              |
|   |            |          |          |          |                      |
|   |            |          |          |          |                      |
|    | <b>No.</b> | <b>A</b> | <b>B</b> | <b>t</b> | <b>Serial Number</b> |
|   | 1          | 25       | 25       | 3        | L-0286               |
|   |            |          |          |          |                      |
|   |            |          |          |          |                      |
| <b>L块</b>   |            |          |          |          |                      |
|   | <b>No.</b> | <b>A</b> | <b>B</b> | <b>t</b> | <b>Serial Number</b> |
|   | 1          | 15.92    | 13.94    | 6.5/4.5  | L-0327               |
|   |            |          |          |          |                      |
|   |            |          |          |          |                      |
| <b>C型槽 C channel (内外C)</b>  |            |          |          |          |                      |
|  | 1          | 82       | 31       | 3.17     | CX-0293              |
|   | 2          | 60       | 31       | 3.17     | CX-0292              |
|   |            |          |          |          |                      |

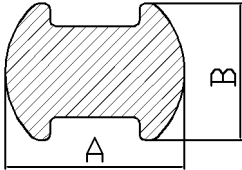
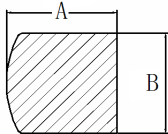
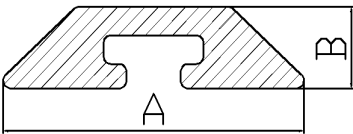
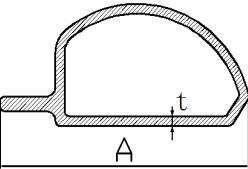
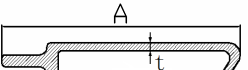
| 梅花棒 cross rod 1   |   | A     | B     | Serial Number |
|---|---|-------|-------|---------------|
|    | 1 | 14    | 10.54 | MH-0298       |
|   | 2 | 9.11  |       | MH-0387       |
|   |   |       |       |               |
|   |   |       |       |               |
| 梅花插条 cross rod 2  |   | A     | B     | Serial Number |
|    | 1 | 7.5   | 7     | MH-0299       |
|   | 2 | 7     | 5     | MH-0388       |
|   |   |       |       |               |
|   |   |       |       |               |
| 平板插条 connector  |   | A     | B     | Serial Number |
|   | 1 | 39    | 10    | PC-0302       |
|   |   |       |       |               |
|   |   |       |       |               |
|   |   |       |       |               |
| 上托盘 top tray beam   |   | A     | t     | Serial Number |
|  | 1 | 171.4 | 5     | ST-0335       |
|   |   |       |       |               |
|   |   |       |       |               |
|   |   |       |       |               |
| 下托盘 bottom tray beam  |   | A     | t     | Serial Number |
|  | 1 | 209.6 | 6     | XT-0336       |
|   |   |       |       |               |

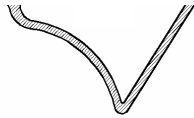

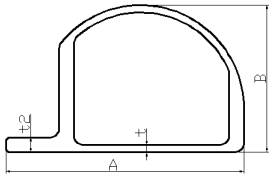
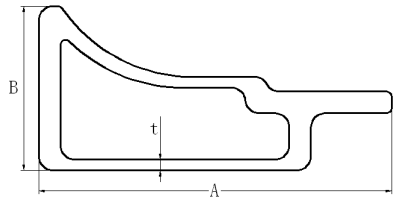
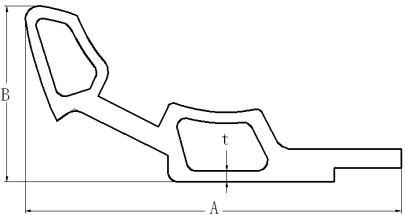
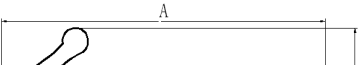
| 上唇材  |   | A      | B     | t/t2      | Serial Number |
|------|---|--------|-------|-----------|---------------|
| 1    |    | 157.23 | 97.03 | 4.83/9.65 | SC-0364       |
| 下唇材  |   | A      | B     | t         | Serial Number |
|      |    | 157.23 | 97.03 | 4.83      | XC-0365       |
| 鱼上唇材 |   | A      | B     | t         | Serial Number |
|      |  | 177.77 | 81.51 | 5.08      | YSC-0366      |
| 鱼下唇材 |   | A      | B     | t         | Serial Number |
|      |  | 180.8  | 114.7 | 5.08      | YSC-0367      |

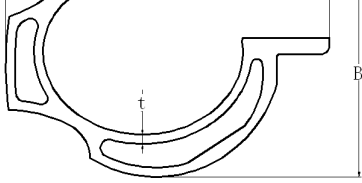
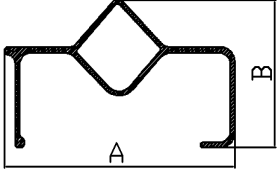
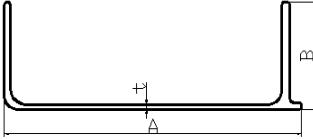
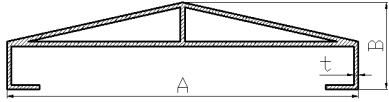
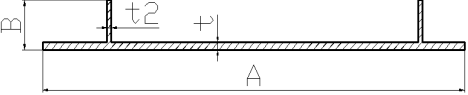
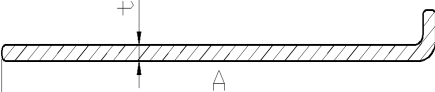
|   |   |              |          |             |                      |
|---|---|--------------|----------|-------------|----------------------|
|    |   |              |          |             |                      |
| <b>Σ型材 "Σ" profile</b>  |   | <b>A</b>     | <b>B</b> |             | <b>Serial Number</b> |
|    | 1 | 190.2        | 77       |             | XG-0282              |
|   | 2 | 190.2        | 114.81   |             | XG-0316              |
|   | 3 | 190.2+114.81 | 114.81   |             | XG-0317              |
|   |   |              |          |             |                      |
| <b>槽型刮板</b>   |   | <b>A</b>     | <b>B</b> | <b>t</b>    | <b>Serial Number</b> |
|    | 1 | 188.9        | 63.5     | 3.05        | C-0357               |
|   |   |              |          |             |                      |
|   |   |              |          |             |                      |
| <b>报警盒三角材</b>   |   | <b>A</b>     | <b>B</b> | <b>t</b>    | <b>Serial Number</b> |
|   |   | 268          | 65       | 3.5         | ST-0360              |
|   |   |              |          |             |                      |
|   |   |              |          |             |                      |
| <b>报警盒底板</b>  |   | <b>A</b>     | <b>B</b> | <b>t/t2</b> | <b>Serial Number</b> |
|  | 1 | 246          | 27       | 4/2.5       | DB-0363              |
|   |   |              |          |             |                      |
|   |   |              |          |             |                      |
| <b>插板</b>   |   | <b>A</b>     | <b>t</b> |             | <b>Serial Number</b> |
|  | 1 | 100          | 3        |             | CB-0301              |
|   |   |              |          |             |                      |
|   |   |              |          |             |                      |

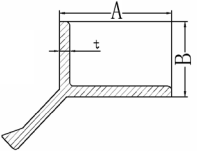
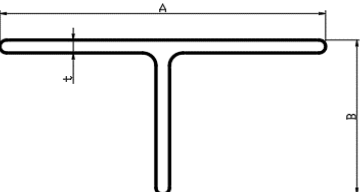
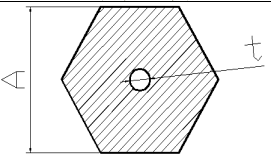
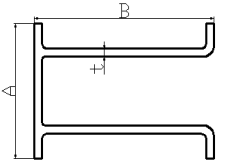
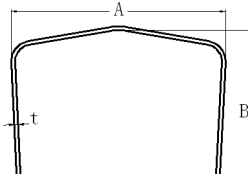
| Y型材   |   |       |       |               |               |
|---|---|-------|-------|---------------|---------------|
|   |   | A     | B     | t             | Serial Number |
|    | 1 | 55    | 35    | 5             | Y-0283        |
|   |   |       |       |               |               |
|   |   |       |       |               |               |
| T型材   |   |       |       |               |               |
|   |   | A     | B     | t             | Serial Number |
|    | 1 | 152.4 | 76.2  | 6.35          | T-0640        |
|   | 2 | 50    | 38    | 2/4           | T-0849        |
|   | 3 | 40    | 11    | 2             | T-0855        |
|   |   |       |       |               |               |
| 六角型材  |   |       |       |               |               |
|   |   | A     | t     | Serial Number |               |
|    | 1 | 22    | 6.5   | L-0345        |               |
|   |   |       |       |               |               |
|   |   |       |       |               |               |
| P型材   |   |       |       |               |               |
|   |   | A     | B     | t             | Serial Number |
|   | 1 | 100   | 140   | 5             | P-0395-2      |
|   |   |       |       |               |               |
|   |   |       |       |               |               |
|   |   |       |       |               |               |
| 防护罩   |   |       |       |               |               |
|   |   | A     | B     | t             | Serial Number |
|  | 1 | 169.2 | 137.2 | 2.8           | Z-0369        |
|   | 2 | 162   | 130   | 2.8           | Z-0370        |
|   | 3 | 111   | 30    | 2.1           | G-0480        |
|   |   |       |       |               |               |

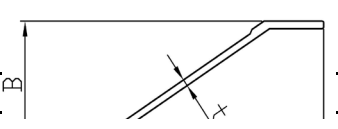
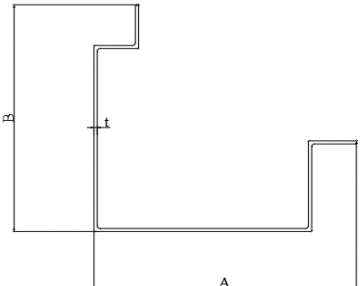
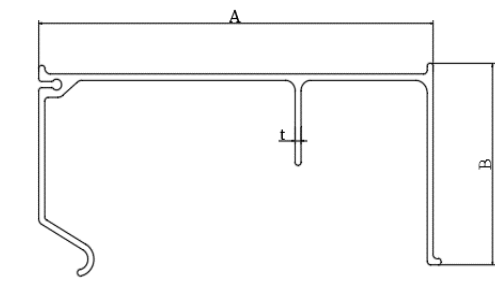
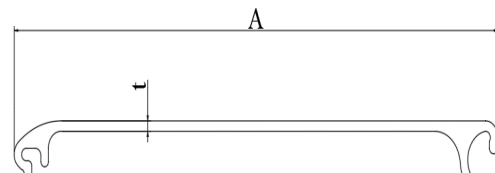

| 刮泥器   |   | A      | B   | t   | Serial Number |
|---|---|--------|-----|-----|---------------|
|    | 1 | 75     | 34  | 1.8 | YP-0476       |
|   | 2 | 70     | 28  | 2   | YP-0765       |
| 刮泥板   |   | A      | B   | t   | Serial Number |
|    | 1 | 241    | 228 | 3   | ZXB-0823      |
|   | 2 | 241    | 181 | 3   | ZXB-0828      |
|   | 3 | 240    | 140 | 3   | ZXB-0836      |
|   | 4 | 320    | 180 | 3   | ZXB-0837      |
|   | 5 | 210    | 200 | 3   | ZXB-0841      |
|   |   |        |     |     |               |
|   |   |        |     |     |               |
|   |   |        |     |     |               |
|   |   |        |     |     |               |
| 刮泥板盖  |   | A      | B   | t   | Serial Number |
|   |   | 200    | 95  | 3   | GNB-0825      |
|   |   |        |     |     |               |
|   |   |        |     |     |               |
|   |   |        |     |     |               |
|   |   |        |     |     |               |
|   |   |        |     |     |               |
|   |   |        |     |     |               |
|   |   |        |     |     |               |
| 刮泥板盖  |   | A      | B   | t   | Serial Number |
|  |   | 190.92 |     | 3   | GNB-0829      |
|   |   |        |     |     |               |
|   |   |        |     |     |               |
|   |   |        |     |     |               |
|   |   |        |     |     |               |
|   |   |        |     |     |               |
|   |   |        |     |     |               |
|   |   |        |     |     |               |

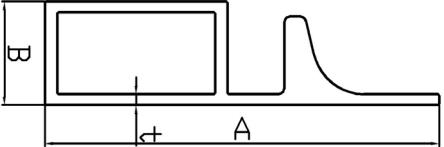
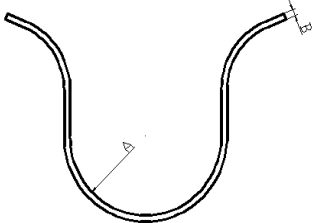
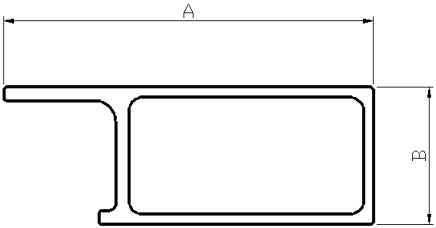
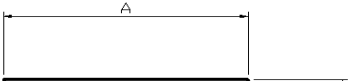
| F型材   |   |     |    |    |               |
|---|---|-----|----|----|---------------|
|    |   | A   | B  | t  | Serial Number |
|   |   | 190 | 48 | 5  | F-0482        |
| 开口圆型材   |   |     |    |    |               |
|    |   | A   |    | B  | Serial Number |
|   | 1 | 38  |    | 3  | KY-0515       |
|   | 2 | 10  |    | 3  | KKY-0573      |
|   | 3 | 25  |    | 3  | KKY-0574      |
|   | 4 | 45  |    | 3  | KKY-0575      |
|   |   |     |    |    |               |
| 转角板   |   |     |    |    |               |
|   |   | A   |    | B  | Serial Number |
|   | 1 | 111 |    | 40 | ZJ-0534       |
|   |   |     |    |    |               |
|   |   |     |    |    |               |
|   |   |     |    |    |               |
|   |   |     |    |    |               |
|   |   |     |    |    |               |
|   |   |     |    |    |               |
| 拼接头   |   |     |    |    |               |
|  |   | A   |    | B  | Serial Number |
|   | 1 | 60  |    | 40 | PJ-0535       |
|   |   |     |    |    |               |



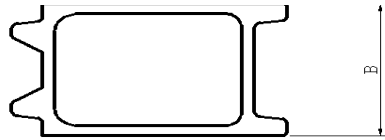

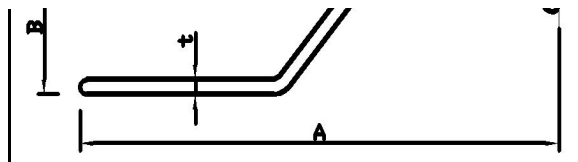
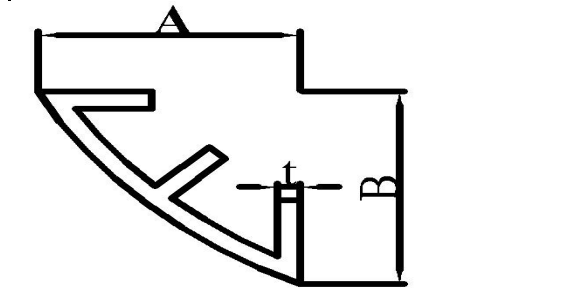
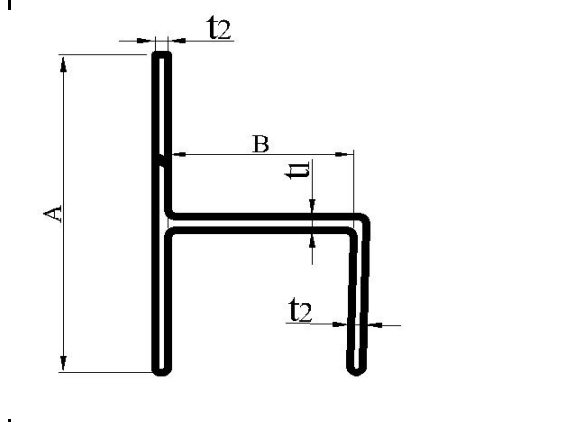
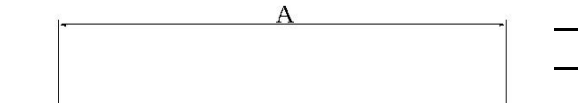

| 屋顶异型材 |    |        |      |               |           |
|-------|----|--------|------|---------------|-----------|
|       | A  | B      | t    | Serial Number |           |
|       | 1  | 68.4   | 65   | 2.5           | WDYC-0557 |
|       | 2  | 71.8   | 70   | 2.5           | WDYC-0660 |
|       | 3  | 103.4  | 65   | 2.5           | WDYC-0556 |
|       | 4  | 153.4  | 65   | 2.5           | WDYC-0647 |
|       | 5  | 206.6  | 90   | 3.5           | WDYC-0661 |
|       | 6  | 110.25 | 90   | 2.5           | WDYC-0718 |
|       | 7  | 70     | 75   | 2.5           | WDYC-0719 |
|       | 8  | 106.8  | 70   | 2.5           | WDYC-0744 |
|       | 9  | 156.6  | 90   | 2.5           | WDYC-0745 |
|       | 10 | 102.5  | 90   | 2.5           | WDYC-0817 |
|       | 1  | 100    | 75   | 2.5           | WDYC-0559 |
|       | 2  | 150    | 75   | 2.5           | WDYC-0746 |
|       |    |        |      |               |           |
|       | 4  | 90     | 22.5 | 2.5           | WDYC-0558 |
|       |    |        |      |               |           |

|   |        |     |    |       |               |
|---|--------|-----|----|-------|---------------|
|    |        |     |    |       |               |
| 带肋曲板  |        | A   | B  | t     | Serial Number |
|    | 1      | 69  | 69 | 6     | QB-0619       |
| H型材   | al Num | A   | B  | t1/t2 | Serial Number |
|   | 1      | 223 | 51 | 4/3.5 | HX-0646       |
|   |        |     |    |       |               |
| 异形工字钢   | al Num | A   | B  | t1/t2 | Serial Number |
|  | 1      | 156 | 65 | 12/4  | I-0643        |

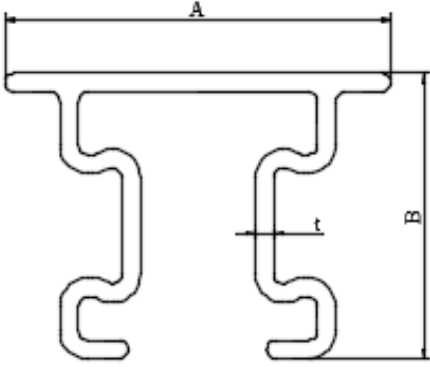
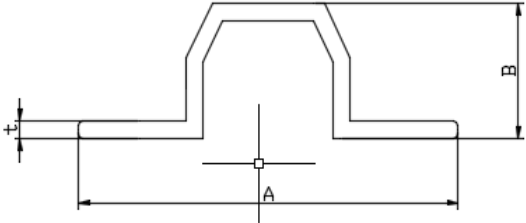

|   |        |     |    |       |               |
|---|--------|-----|----|-------|---------------|
|   |        |     |    |       |               |
| 支架异型材   | al Num | A   | B  | t1/t2 | Serial Number |
|    |        | 84  | 60 | 4     | YX-0695       |
|   |        |     |    |       |               |
|   |        |     |    |       |               |
|   |        |     |    |       |               |
|   |        |     |    |       |               |
|   |        |     |    |       |               |
|   |        |     |    |       |               |
|   |        |     |    |       |               |
|   |        |     |    |       |               |
|   |        |     |    |       |               |
| 礼帽型材  | al Num | A   | B  | t1/t2 | Serial Number |
|   |        | 88  | 30 | 3.9   | YX-0716       |
|   |        | 170 | 77 | 6     | YX-0741       |
|   |        |     |    |       |               |
|   |        |     |    |       |               |
|   |        |     |    |       |               |
|   |        |     |    |       |               |
|   |        |     |    |       |               |
|   |        |     |    |       |               |
|   |        |     |    |       |               |
|   |        |     |    |       |               |
| 气浮板   | al Num | A   | B  | t1/t2 | Serial Number |
|  |        | 155 | 57 | 3.5   | YX-0717       |
|   |        |     |    |       |               |
|   |        |     |    |       |               |
|   |        |     |    |       |               |

















































#REF!





|  |  |  |  |  |  |
|--|--|--|--|--|--|
|  |  |  |  |  |  |
|  |  |  |  |  |  |

**Injection moulded parts**

Cast-in-place wall connectors

| 序号 | A   | B  | Serial Number |
|----|-----|----|---------------|
| 1  | 320 | 30 |               |
| 2  | 75  |    | ZS-0691       |
|    | 180 | 90 | ZS-0714       |
|    |     |    |               |
|    |     |    |               |
|    |     |    |               |
|    |     |    |               |
|    |     |    |               |

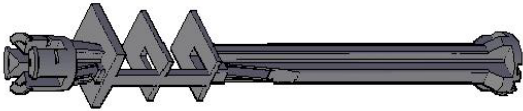

|  |  |  |  |  |
|--|--|--|--|--|
|  |  |  |  |  |
|--|--|--|--|--|

100      70



AUX1L9B

