

FSD11 Series

# LASER CCD LINE DIAMETER MEASUREMENT SENSOR



## Precautions

- Please do not use in the following environment
  - Direct sunlight
  - Places with high humidity or easy condensation
  - Places containing corrosive gases
  - Places subject to severe vibration or shock
- Connection and installation
  - Do not use the sensor in an unstable state immediately after the power is turned on, it is recommended to test after 30 minutes of power on to achieve desired accuracy
  - Be sure to carry out wiring with the power off. If a wrong wiring occurs, it will cause a malfunction
  - Please make sure that the power supply voltage is within the rated value before powering on
  - Please use rated load
  - The RS485 signal line cannot be short-circuited with the power supply, otherwise it may cause product failure or damage the product
  - When installing the sensor, do not subject the sensor to severe external forces (such as hammering, etc.), as this may damage the sensor performance
  - Do not bend the lead out of the cable with excessive force, and avoid applying pressure such as pulling
- Cleaning
  - Thinner will corrode the surface of the filter, it is best to avoid using it
  - If there is dust on the surface, please wipe it gently with a dry dust-free cloth

## Safety Warning

- Do not use in an environment with flammable, explosive or corrosive gases.
- Do not use in an environment with oil or chemicals.
- Do not use in an environment with high humidity.
- Do not use in direct sunlight.
- Do not use under other environmental conditions that exceed the rated value.
- Do not disassemble, repair or modify the product without permission.

## End-of-life Disposal

When the product is disposed of, please dispose of it as industrial waste.

## Operation instruction

Series	Digital Display Laser Displacement Sensor			Digital display laser distance measuring sensor		
	FSD11-30 series	FSD11-50 series	FSD11-85 series	FLR-10 series	FLR-50 series	FLR-100 series
Measuring center distance	30mm	50mm	85mm	/	/	/
Measuring range	±5mm	±15mm	±25mm	30...100mm	80...500mm	150...1000mm
Full range(F.S.)	10mm	30mm	50mm	70mm	420mm	850mm
Supply voltage	RS-485: 10...30VDC; 4...20mA: 12...24VDC			RS-485: 10...30VDC; 4...20mA: 12...24VDC		
Consumption power	≤700mW			≤700mW		
Load current	200mA			200mA		
Voltage drop	<2.5V			<2.5V		
Light source type	Red laser(650nm);Laser level:Class 2			Red laser(650nm);Laser level:Class 2		
Light spot size	Φ0.5mm@30mm	Φ0.5mm@50mm	Φ0.5mm@85mm	1mm*3mm@100mm	Φ2.5mm@500mm	Φ3mm@1000mm
Dimension	65*51*23mm			65*51*23mm		
Resolution	2.5um@30mm	10um@50mm	30um@85mm	5um@30mm;50um@100mm	15um@80mm;50um@500mm	50um@150mm;2000um@1000mm
Linear accuracy①②	Please refer to the specification of specific models			Please refer to the specification of specific models		
Repeated stability①②③	5um	20um	60um	10um@30mm 30um@50mm 100um@100mm	30um@80mm 250um@500mm 1000um@500mm	100um@150mm 520um@500mm 4000um@1000mm
Output 1	Digital value:RS-485(Support ModBus protocol);Analog:4...20mA(Load resistance<390Ω)			Digital value:RS-485(Support ModBus protocol);Analog:4...20mA(Load resistance<390Ω)		
Output 2	Switch value:PUSH-PULL/NPN/PNP/NO/NC Settable			Switch value:PUSH-PULL/NPN/PNP/NO/NC Settable		
Distance setting	RS-485:keypress/RS-485 setting;4...20mA:keypress setting			RS-485:keypress/RS-485 setting;4...20mA:keypress setting		
Temperature drift	±0.08%F.S./°C	±0.02%F.S./°C	±0.04%F.S./°C	±0.02%F.S./°C		
Response time	2ms, 16ms, 40ms Settable			2ms, 16ms, 40ms Settable		
Indicator	Power indicator:Green LED;Motion indicator:Yellow LED;Alarm indicator:Yellow LED			Power indicator:Green LED;Motion indicator:Yellow LED;Alarm indicator:Yellow LED		
Display	OLED Display(Size:14*10.7mm)			OLED Display(Size:14*10.7mm)		
Built-in function④	●Slave address&Port rate setting ●Zero set ●Product self-check ●Output setting ●Parameter query ●Average setting ●Analog map settings ●Single point teach ●Window teach ●Factory default			●Slave address&Port rate setting ●Average setting ●Product self-check ●Output setting ●Parameter query ●Average setting ●Analog map settings ●Single point teach ●Window teach		
Protection circuit⑤	Short circuit,reverse polarity,overload protection			Short circuit,reverse polarity,overload protection		
Service environment	Operating temperature:-10...+50°C;Storage temperature:-20...+70°C Environment humidity:35...85%RH(No condensation)			Operating temperature:-10...+50°C;Storage temperature:-20...+70°C Environment humidity:35...85%RH(No condensation)		
Anti ambient light	Incandescent light:<3,000 lux			Incandescent light:<3,000 lux		
Protection degree	IP67			IP67		
Material	Housing:Aluminium;Lens cover:PMMA Display panel:PC			Housing:Aluminium;Lens cover:PMMA Display panel:PC		
Vibration resistant	10...55Hz Double amplitude 1mm, 2hrs each for X,Y,Z direction			10...55Hz Double amplitude 1mm, 2hrs each for X,Y,Z direction		
Impulse withstand	500m/s²(About 50G), 3 times each for X,Y,Z direction			500m/s²(About 50G), 3 times each for X,Y,Z direction		
Connection way	2m 5pin/4pin PVC cable(5pin:RS-485 output;4pin:Analog output)			2m 5pin/4pin PVC cable(5pin:RS-485 output;4pin:Analog output)		
Accessory	Screw(M4×35mm)×2, Nut×2, Washer×2, Mounting bracket, Operation manual			Screw(M4×35mm)×2, Nut×2, Washer×2, Mounting bracket, Operation manual		

### Remark:

- ①Test conditions:Standard data at 23 ± 5 °C;Supply voltage 24VDC;30 minutes' warmup before test;Sampling period 2ms;Average sampling times 100;Standard sensing object 90% white card
- ②The statistical data follows the 3σ criteria
- ③Repeat accuracy:23 ± 5 °C environment,90% reflectivity white card,100 test data results
- ④Slave address,baud rate setting only for RS-485 series
- ⑤Protection circuit only for switch output

## Panel introduction

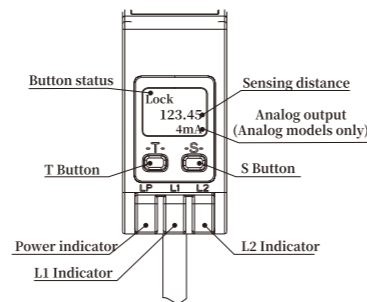

### 1.Button

Used to set the switch output logic of the sensor,operating point,reset,unlock,address,baud rate query,data filtering and analog.

T	Toggle button	Switch button
S	Set button	Set button

### 2.Indicator

Used to power indicator,sensing indication,alarm indicator

Product name	Color	Always on / off	Flashing
LP	Green LED	Power indicator	—
L1	Yellow LED	Sensing indicator	Alarm
L2	Yellow LED		

### 3.Display

Used to display key status,current measured value,current output value,current setting status, setting menu.

Display content	Description
Button status	Button LOCK,Button UNLOCK,RUN
Sensing distance	Real-time display of the distance value and displacement value measured by current sensor
Analog output	Real-time display of current sensor measurement value conversion output current value
NO DIS	Data transmission error,no measured value display(sensor failure)
OutofRange	Out of sensing range
Over Load	Switch output overload
OK	Parameter setting successfully
ERROR	Parameter setting failed(set point is outside the sensing range)

### 4.Self-lock and Unlock

**Self-lock:**If there is no key press within 10 minutes after powering on,it will beself-locking. After the keys are locked,the screen displays LOCK.The corresponding setting operation cannot be performed.  
**Unlock:**When the button is in the self-locking state,press and hold the S button for 4s...6s. When the screen displays UNLOCK,release the S button.

## Function Description

### 1.Status query

Analog output:Output logic logic,output status out,hold limit hold value,filtered wave Aver;  
RS-485 output:Output logic logic,output status out,slave address Addr,baud rate Baud,filtered wave Aver.

### 2.Setting function

Functional category	FSD11 series
Action point single point teaching TEACH A	FLR** Full series FSD11** Full series
Operation point window teaching TEACH A, TEACH B	
Output logic: NO/NC selection	
Output status out:NPN/PNP/PUSH-PULL(P)selection	
Filter level Aver: FAST / MEDIUM / SLOW selection	
Reset	
Analog mapping 4mA	
Analog mapping 20mA	FLR** Analog output series
Overrun hold value	FSD11** Analog output series
Zero	FSD11** 485 output series

### ● Action point single point teaching TEACH A

Within the sensing range,select the first distance value as the operating point and fix the product and the target.On the main interface,short press S to enter "Teach A"Then long press the S key to start teaching.After successful teaching,within the sensing range, select the second distance value as the operating point and fix the product and the target.  
 Short press T to enter "Teach B" and then long press S to start teaching.  
 If you want to return to single-point teaching after completing window teaching, only need to operate "single point teaching", the product will automatically clear the last window teaching value.  
 Actual operating point: Set value \* 101%; Actual exit point: Less than set value \* 102%.  
 After teaching at specified position,output ON within the range between 2 positions.

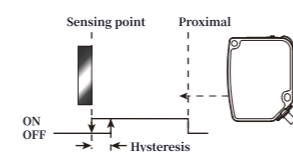

### ● Action point window teaching TEACH A, TEACH B

Within the sensing range,select the first distance value as the operating point and fix the product and the target.On the main interface,short press S to enter "Teach A"Then long press the S key to start teaching.After successful teaching,within the sensing range, select the second distance value as the operating point and fix the product and the target.  
 Short press T to enter "Teach B" and then long press S to start teaching.  
 If you want to return to single-point teaching after completing window teaching, only need to operate "single point teaching", the product will automatically clear the last window teaching value.  
 Actual operating point: Set value \* 101%; Actual exit point: Less than set value \* 102%.  
 After teaching at the specified 2 positions,the output is ON within the range between 2 positions.

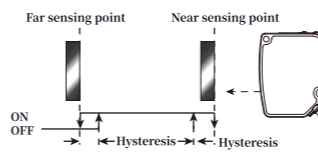

### ● Analog mapping: 4mA or 20mA

Within the range,select the first distance value as the 4mA mapping point (or 20mA mapping point) and fix the product and the target.Within the effective range,the position of 4mA and 20mA (A,B) points can be set arbitrarily,and the distance between (A,B) points is greater than 0.5mm, it can be set successfully,otherwise the setting will fail,the default (A,B) is (4mA,20mA).

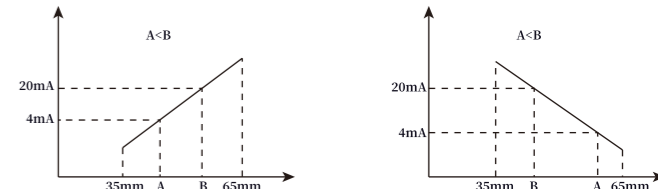

### ● Overrun hold value:Hold

When reaching the Hold interface,short press the S key to enter the Max setting interface,then short press T key to select Max or Min,then long press S key to set,there are two modes to hold overrun output: The maximum value (20mA) and the minimum value (4mA),and the default maximum value is 20mA.

Max: When over range, the display shows 20mA.Analog output 20mA.

Min: When over range,the display shows 4mA.Analog output 4mA.

### ● Zero

Select the first distance value as the zero point and fix the product and the target. On the main interface,short press the S key to enter the "setting interface" and then short press the T key,when reaching the "Zero" interface,long press the S key to start the zero setting.

### ● Reset

Analog output: ①PNP NO; ②Single point teaching mode (Range center point).  
RS-485 output: ①PNP NO; ②Baud rate: 115200; ③Address 0x80; ④Single point teaching mode (Range-center point); ⑤Zero reset (Displacement sensor only, default center point).

## Instructions

### 1.FSD11\*\*, FLR\*\*Analog output series

Perform the following operations in the unlocked state:

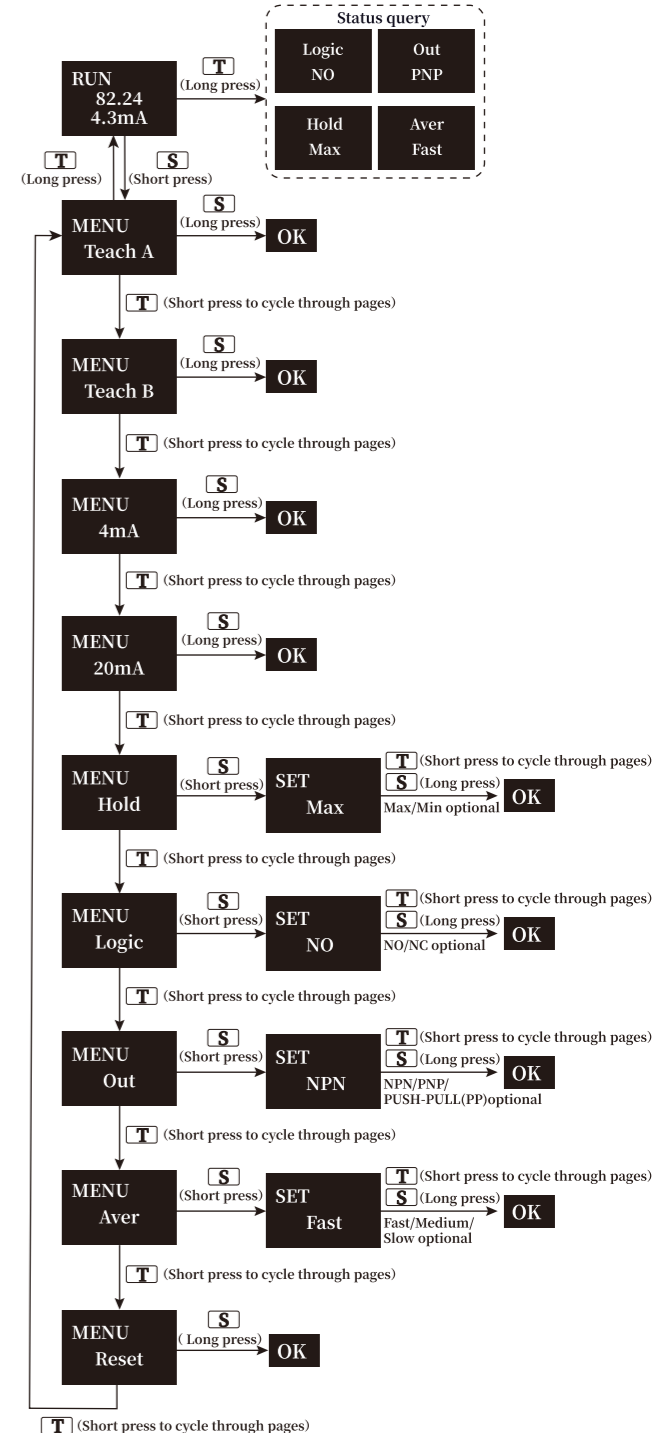

2.FSD11\*\*、FLR\*\*485 Output series  
Perform the following operations in the unlocked state:

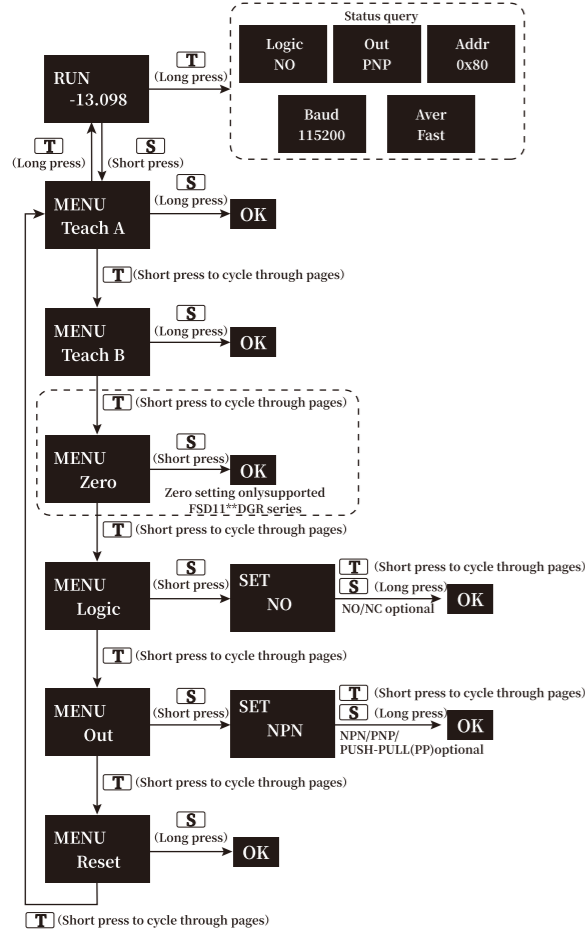

3.Setting waiting interface: When long press S key to set, you will be prompted with three solid dots to indicate the setting progress (Take Teach A as an example):



- \*1 Long press: 4...6s, Short press: <2s;  
Successful teaching OK: L1 and L2 flash simultaneously at 4Hz for about 3 seconds;  
Teaching failed ERROR: L1 and L2 flash asynchronously at a frequency of 4Hz for about 3 seconds;
- \*2 Status query: Each display content interval is 1s; Polling display twice automatically returns to the main page;
- \*3 Back to the main interface (RUN): When in the "MENU" and "SET" interface, long press the T key, you can return to the main interface.

## Wiring diagram

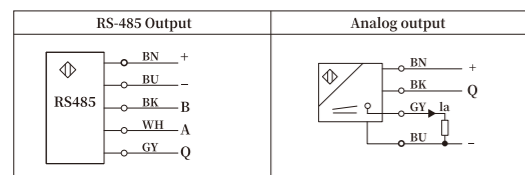

Remark: The sensors are equipped with shielded cables, Q is the switch output.  
RS-485 output: The black and white lines A and B must not be reversed and A and B cannot be short-circuited with the power line "+, -".  
Analog output: The gray line Ia cannot be short-circuited with the power line "+, -". There is a small shielded wire, which shall not be in short-circuit connection with the analog output wire, but recommended to be grounded or not grounded.

## Data transmission (only for RS485)

- ◆ Baud rate: 115200 (default) ◆ Parity check: None ◆ Data bits: 8
  - ◆ Stop bit: 1 ◆ Slave default address: 0x80
- Note: The default address is 0x80. Different slave addresses or different baud rates will have different redundancy checks.

1. Master station request message format (Command to read distance information)

Slave address	Function code	Data start address	Data volume (Unit: words)	Redundancy check CRC16-2
80	03	9C	7d	MSB:00 LSB:01 LSB:24 MSB:53

Slave station response message format:

Slave address	Function code	Bytes	Data	Redundancy check CRC16-2
80	03	02	MSB LSB	LSB MSB

The host computer communicates through RS485, and the sensor data read out needs to be calculated by the following method to obtain actual measured value.

- ◆ FSD11 (Displacement) series  
30mm Disp=1um, 50mm Disp=2um, 85mm Disp=5um  
Actual measurement value of displacement sensor: Distance=Mid±X\*Disp/1000  
FSD11-30: Distance=30±X\*1/1000  
FSD11-50: Distance=50±X\*2/1000  
FSD11-85: Distance=85±X\*5/1000

- (1) The 4th and 5th bytes in the slave response message are converted to decimal
- (2) The decimal value of the 4th and 5th bytes is not greater than 32768, X=the decimal value of the 4th and 5th bytes, actual measurement value=X\*Disp/1000

(3) The decimal value of the 4th and 5th bytes is greater than 32768, X=the decimal value of the 4th and 5th bytes subtract 65536, actual measurement value=X\*Disp/1000

(4) When MSB=7F and LSB=FF in the response message, it means that the measurement result is out of range, namely out of range

Example 1: For products with a range of 85mm (FSD11-85\*\*), the master request message: 80 03

The 4th and 5th bytes of the slave's response message are 08 3C, converted to decimal 2108, not

Actual measurement value=2108\*5/1000=10.54mm

Actual distance value=Mid+10.540=85+10.540=95.540mm

Example 2: For products with a range of 85mm (FSD11-85\*\*), the master request message: 80 03

The 4th and 5th bytes of the slave's response message are F7 AB, converted to decimal

Actual measurement value=(63403-65536)\*5/1000=-10.665mm

Actual distance value=Mid-10.665=85-10.665=74.335mm

◆ FLR (Distance measuring) series

100mm Disp=10um, 500mm Disp=10um, 1000mm Disp=20um

Distance measuring sensor: Distance=X\*Disp/1000

FLR-10/50: Distance=X\*10/1000

FLR-100: Distance=X\*20/1000

The 4th and 5th bytes in the slave's response message are converted to decimal

Actual measurement value=the decimal value of the 4th and 5th bytes is multiplied by 10, and then divided by 1000, unit is mm

(3) When the MSB and LSB in the response message are both FF, it indicates that the measurement result is over range, that is out of range

Example: For products with a range of 500 mm (FLR-50\*\*), the master request message: 80 03 9C

The 4th and 5th bytes of the slave's response message are 46 6E. Converted to decimal 18030

Actual measurement value=18030\*10/1000=180.30mm

2. The master request message format (The address broadcast call command):

Slave address	Function code	Address where data is stored	Data volume (Unit: words)	Redundancy check CRC16-2
00	06	9C	7E	00 81 06 33

The address broadcast call command is used when the address originally set by the sensor is unclear. Modify any current address value to the required value through broadcast command.

Address modification range: 0x80~0xF4

For example: The address originally set by the sensor is unknown, and you want to set the address to 0x81

Then send instructions via RS485 bus: 00 06 9C 7E 00 81 06 33

The address originally set by the sensor is unknown, and you want to set the address to 0x82

Then send instructions via RS485 bus: 00 06 9C 7E 00 82 46 32

Return: There is no return no matter the setting is successfully or fails

3. Master station request message format (Modified address command):

Slave address	Function code	Address where data is stored	Modify value	Redundancy check CRC16-2
80	06	9C	7E	00 85 LSB:18 MSB:30

Slave station response message format:

Slave address	Function code	Address where data is stored	Modify value	Redundancy check CRC16-2
80	06	9C	7E	00 85 LSB:18 MSB:30

The modification is invalid if the modified address is out of range. Return error instruction:

Slave address	Function code	Error code	Redundancy check CRC16-2
80	06	02	LSB MSB

The address modification instruction is used to modify any current address value to the required value when the address originally set by the sensor is known. Modify any current address value to the required value through.

Address modification range: 0x80~0xF4. The effective range of the address setting is 0x80~0xF4, and the modification of address takes effect after the power is turned on again

For example: The address originally set by the sensor is known, and you want to set the address to 0x81

Then send instructions via RS485 bus: 80 06 9C 7E 00 81 19 F3

The address originally set by the sensor is known, and you want to set the address to 0x82

Then send instructions via RS485 bus: 81 06 9C 7E 00 82 58 23

Return: If the setting is successful, the original instruction will be returned; if it fails, an error instruction will be returned

4. Master station request message format (Modify the baud rate):

Slave address	Function code	Address where data is stored	Modify value	Redundancy check CRC16-2
80	06	9C	7F	MSB:00 LSB:02 LSB:09 MSB:92

MSB defaults to 00; The LSB bit of the modified value: Baud rate setting, as follows:

115200	57600	38400	19200	9600
01	02	03	04	05

After setting successfully, slave station response message format:

Slave address	Function code	Address where data is stored	Modify value	Redundancy check CRC16-2
80	06	9C	7F	MSB LSB LSB MSB

If it is not within this range, this operation is invalid. The return operation error command:

Slave address	Function code	Error code	Redundancy check CRC16-2
80	86	02	LSB MSB

The baud rate modification command is used when the baud rate originally set by the sensor is known. Modify any current baud rate value to the required value through the baud rate modification instruction.

Address modification range: 115200, 57600, 38400, 19200, 9600 (Level 5). The default baud rate of the slave is 0x01 (115200). The effective range of the baud rate setting is 0x01~0x05

For example: The baud rate originally set by the sensor is known to be 115200, at this time, you want to set the baud rate to 57600

Then send instructions via RS485 bus: 80 06 9C 7F 00 02 09 92

The baud rate originally set by the sensor is known to be 115200, at this time, you want to set the baud rate to 9600

Then send instructions via RS485 bus: 80 06 9C 7F 00 05 48 50

Return: If the setting is successful, the original instruction will be returned; if it fails, an error instruction will be returned

5. Master station request message format (Switching logic setting):

Slave address	Function code	Address where data is stored	Modify value	Redundancy check CRC16-2
80	06	9C	74	MSB:00 LSB:00 LSB:F9 MSB:91

After setting successfully, slave station response message format:

Slave address	Function code	Address where data is stored	Modify value	Redundancy check CRC16-2
80	06	9C	74	MSB:00 LSB:00 LSB:F9 MSB:91

The switch logic setting instruction is used to modify any current output logic to the required logic value.

Modification range: NPN, PNP, PUSH-PULL (Three kinds)

For example: If you need set the sensor switch value to NPN

Then send commands via RS485 bus: 80 06 9C 74 00 00 F9 91

If you need set the sensor switch value to PNP

Then send commands via RS485 bus: 80 06 9C 74 00 01 38 51

If you need set the sensor switch value to PUSH-PULL

Then send commands via RS485 bus: 80 06 9C 74 00 02 78 50

Return: If the setting is successful, the original instruction will be returned; if it fails, an error instruction will be returned

6. Master station request message format (Switch state setting):

Slave address	Function code	Address where data is stored	Modify value	Redundancy check CRC16-2
80	06	9C	73	MSB:00 LSB:00 LSB:48 MSB:50

After setting successfully, slave station response message format:

Slave address	Function code	Address where data is stored	Modify value	Redundancy check CRC16-2
80	06	9C	73	MSB:00 LSB:00 LSB:48 MSB:50

The switch status setting instruction is used to modify any current output status to the required logic value.

Modification range: NO, NC (Two kinds)

For example: If you need set the sensor switch value to NO

Then send commands via RS485 bus: 80 06 9C 73 00 00 48 50

If you need set the sensor switch value to NC

Then send commands via RS485 bus: 80 06 9C 73 00 01 89 90

Return: If the setting is successful, the original instruction will be returned; if it fails, an error instruction will be returned

7. Master station request message format (Filter times setting):

Slave address	Function code	Address where data is stored	Modify value	Redundancy check CRC16-2
80	06	9C	77	MSB:00 LSB:00 LSB:09 MSB:91

After setting successfully, slave station response message format:

Slave address	Function code	Address where data is stored	Modify value	Redundancy check CRC16-2
80	06	9C	77	MSB:00 LSB:00 LSB:09 MSB:91

The order of filter times is used to set any current filter times as the required filter value.

Modification range: Fast, Medium, Slow (Three kinds)

For example: If you need to set the filter times of the sensor to Fast (1st Filtering)

Then send instructions via RS485 bus: 80 06 9C 77 00 00 09 91

If you need to set the filter times of the sensor to Medium (8st Filtering)

Then send instructions via RS485 bus: 80 06 9C 77 00 01 C8 51

If you need to set the filter times of the sensor to Slow (20st Filtering)

Then send instructions via RS485 bus: 80 06 9C 77 00 02 88 50

Return: If the setting is successful, the original instruction will be returned; if it fails, an error instruction will be returned

8. Master station request message format (Zero setting, only the displacement sensor with RS485 output has this function):

Slave address	Function code	Address where data is stored	Modify value	Redundancy check CRC16-2
80	06	9C	73	MSB:00 LSB:00 LSB:48 MSB:50

After setting successfully, slave station response message format:

Slave address	Function code	Address where data is stored	Modify value	Redundancy check CRC16-2
80	06	9C	73	MSB:00 LSB:00 LSB:48 MSB:50

The zero setting command is used to take any position within the current sensor range as the zero position. Or cancel the current zero position.

Modification range: 0, 01 (Two kinds)

For example: If you need to use the current sensor position as the zero position

Then send instructions via RS485 bus: 80 06 9C 76 00 00 58 51

If you need to cancel the zero position of the current sensor

Then send instructions via RS485 bus: 80 06 9C 76 00 01 99 91

Return: If the setting is successful, the original instruction will be returned; if it fails, an error instruction will be returned

## Installation precautions

Measurement of color difference materials (Install in the direction shown in the figure below to minimize the measurement error)

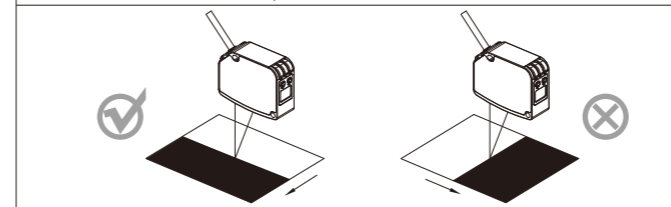

Step surface or segment gap measurement (Install in the direction shown in the figure below to reduce impact by step edges in measurement)

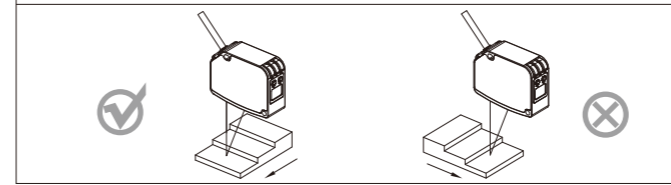

Measurement of rotating objects (Mounting in the direction shown in the figure below to control impact by vertical vibration and position deviation of the object)

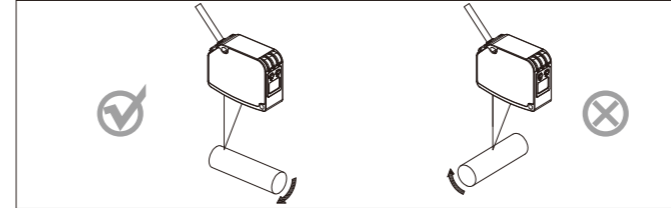

Measurement in narrow places and recessed parts (For installation and measurement in narrow places and holes, take care to avoid blocking the light path from the light-emitting part to the light-receiving part)

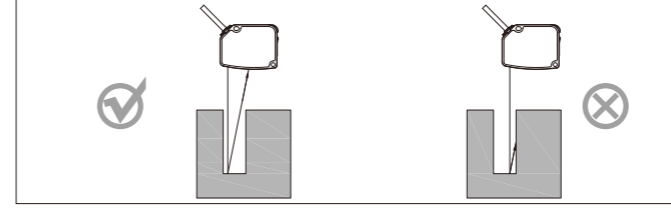

Measurement for wall surface mounting (Install in the direction shown in the figure below to reduce the multiple reflected light from the wall surface, since the reflected light will enter the receiving surface. In case of wall surface high reflection rate, it is better to change to matte black)

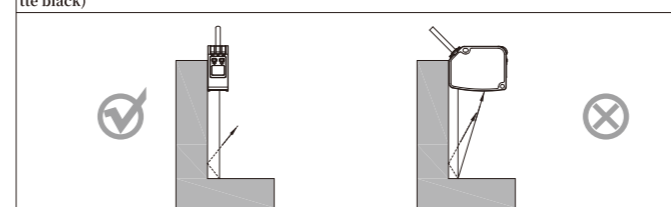

Measurement of shiny objects (Or shiny surface, as shown in the figure below, install the sensor after tilting the sensor at a certain angle)

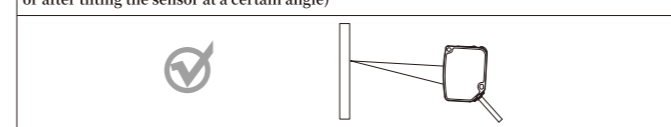

## Dimensions

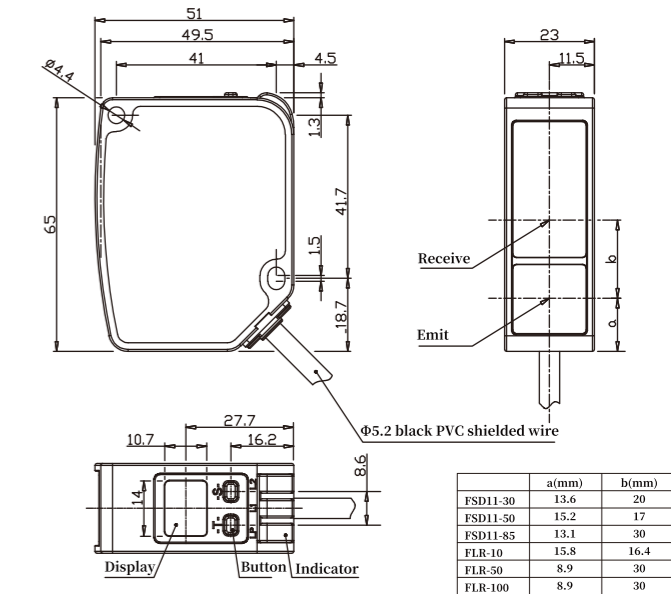

## Accessory Dimensions

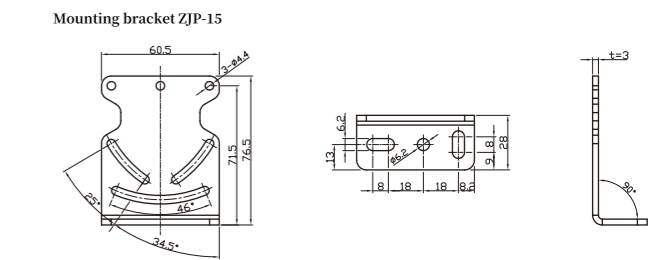

## Installation

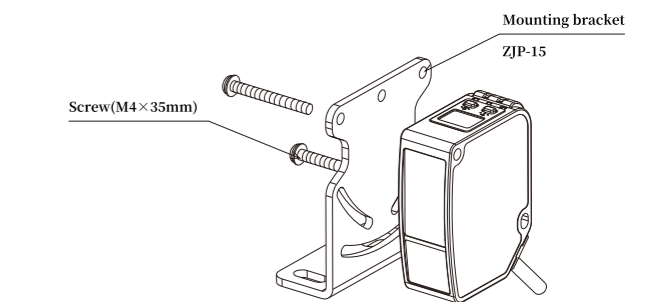

\*For mounting, please keep tightening torque < 0.5N·m

## Laser description



- ◆ This sensor series are Class 2 Laser products, please do not look directly at the laser or observe it through the laser. Warning labels are affixed to this series, please use them according to label instructions.

Product specifications are subject to change without notice.  
For more information or if you have any questions or suggestions about this product, please feel free to contact us.