

SPECIALIZED MANUFACTURER OF TUBULAR MOTORS

孚泰物联科技

NINGBO FUTAI WINDOW
AND DOOR AUTOMATION TECHNOLOGY CO.,LTD.

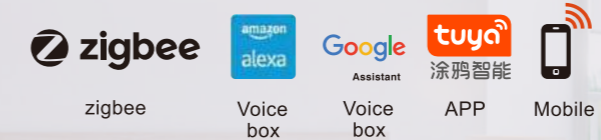

Website



Wechat



WhatsApp

NINGBO FUTAI WINDOW AND DOOR AUTOMATION TECHNOLOGY CO.,LTD.

Wechat: futaiiot
Email: info@futaimotor.com
WhatsApp: +86 18969899661
Web: www.futaimotor.com

宁波孚泰物联科技有限公司

地址: 宁波市江北区长兴路199号4幢301,316,318室
电话: 0574-89063860
网址: www.futaimotor.com

2023/2024
PRODUCT MANUAL

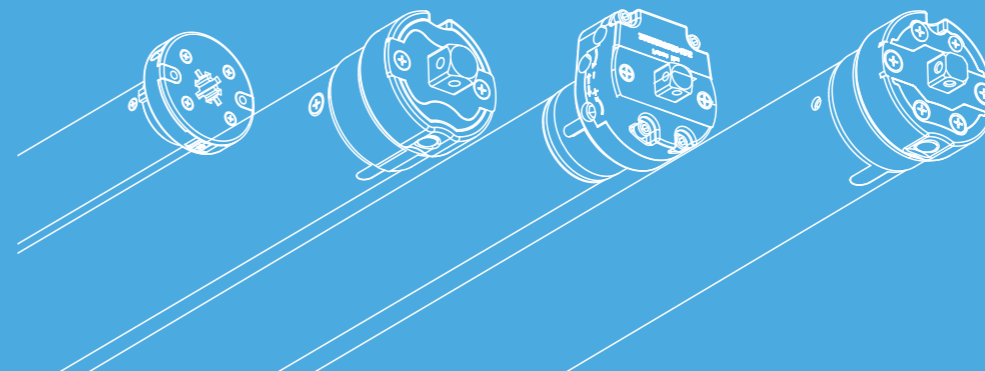

CONTENTS

OUTPUT GREEN PRODUCTS,
SAVE OUR EARTH ENERGY.

www.futaimotor.com

- 01** About US
- 03** Development Path
- 05** FT25LEU Motor
- 07** FT25DS Motor
- 09** FT35TEW Motor
- 11** FT35DM Motor
- 13** FT35LE Motor
- 17** FT15LEU Motor
- 18** FT25CE Motor
- 19** FT25DB Motor
- 20** FT25LEZ Motor
- 21** FT25TE Motor
- 22** FT25TEW Motor
- 23** FT35DS Motor
- 24** FT35E Motor
- 25** FT35EW Motor
- 26** FT35S Motor
- 27** FT35R Motor
- 28** FT45DS Motor
- 29** FT35TE Motor
- 30** FT45EW Motor
- 31** FT45DM Motor
- 32** FT45R Motor
- 33** FT45E Motor
- 34** FT45LE Motor
- 35** FT45S Motor
- 36** FT45M Motor
- 37** FT45MR Motor
- 38** FT59M Motor
- 39** Accessories
- 46** Hand-hold transmitter Remote

ABOUT US

NINGBO FUTAI

www.futaimotor.com



NINGBO FUTAI WINDOW AND DOOR AUTOMATION TECHNOLOGY CO.,LTD.

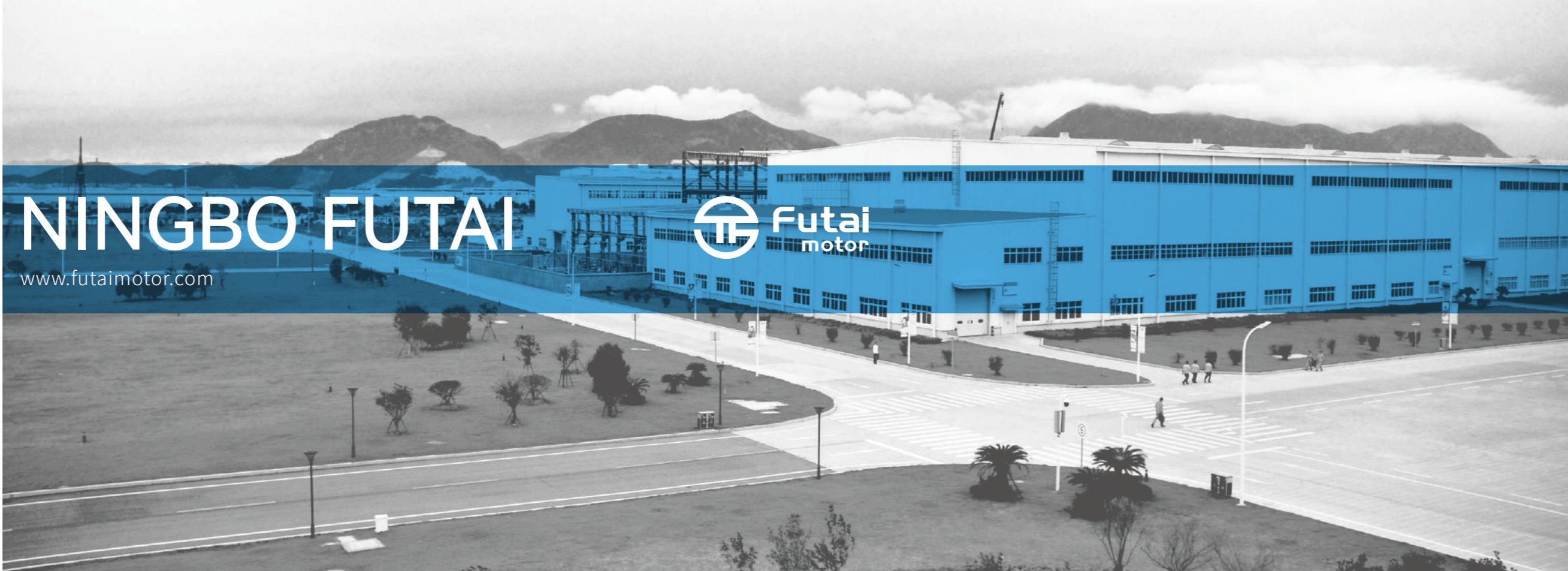

APPLICATION FIELD

Smart home:
door and window shading,
inner shading, indoor
curtains, roller blinds, blinds.

Industry:
roller shutters for car drivers,
roller shutters for buses and
subway windows.

COMPANY PROFILE

Ningbo Futai Window and Door Automation Technology Co., Ltd, located in Ningbo city,Zhejiang China, Specilized in design, manufacturing, sales and service of high-end automatic motors, operators, safety contact edge and control devices for various kind of doors, gates and windows.

The company persists in the basic principle of science and technology, implements “sincerity harmony. creativity” as its management philosophy, strictly abides by the "fine, precise, beautiful" as its manufacturing ideas. Keeping innovation, developing and manufacturing motors, operators for window and doors, sun protection products etc. Our products are mainly used for shutter, screen, awning, roof window, garage doors , roller blinds etc. The products are of ISO9001, CE, TUV, RoHS approved. Mainly exported to Europe, USA, middle east, south America, Australia, southeast Asia market. Welcome to visit us and negotiate the cooperation!

APPLICATION FIELD

DEVELOPMENT PHILOSOPHY

| Uphold the expansion of circular economy and achieve sustainable development

VALUE ORIENTATION
OUR MISSION

| Integrity first, responsibility in mind, innovation-oriented, green practice

| Firmly establish a socialist concept of ecological civilization and promote the formation of a new pattern of harmonious development of human and nature and modernization

COOPERATION IDEA

| Willing to work with all sectors of society to become a new benchmark in the industry!

DEVELOPMENT PATH

NINGBO FUTAI

www.futaimotor.com



NINGBO FUTAI WINDOW AND
DOOR AUTOMATION TECHNOLOGY CO.,LTD.

2005

engaged in the window and door automation and sun protection industry, involved in tubular motor products.

2010

Futai Industrial Co., Ltd. was set up in Hong Kong and engaged in the trading and sales of window and door automation products , product including tubular motors and safety edge.

2014

Ningbo Futai Door and Window Automation Technology Co., Ltd. was registered and founded, engaged in the research, developing, manufacturing and sales of tubular motors and safety edges, three patents were obtained.

2018

Ningbo Futai IOT Technology Co., Ltd. was registered and added into FUTAI group, more advanced equipments were introduced, bigger factory area up to 2000 square meters, strictly and firmly engaged in the manufacturing, R&D, sales and services of tubular motors and safety edge, with three registered trademarks.

2023

During the three years of the pandemic, more research and development of new products was invested, more than 20 new models motor was developed, which including RV awning motor, Rechargeable motors, WiFi motors for voice box and mobile App of Amazon and Google, 15mm motor for smallest roller blinds etc.. 3 new patents obtained, ISO9001, CE ROHS and UKCA approved.

TO DATE



FT25LEU Motor

25mm rechargeable roller blinds tubular motor
25mm 可充电式卷帘电机

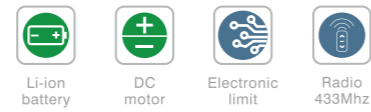

POWER SUPPLY MODE 供电方式

- Solution 1: AC/DC Adapter
Solution 2: Solar panel
Solution 3: Battery Bank
方案 1: 交流/直流适配器
方案 2: 太阳能板
方案 3: 充电宝



Features 产品特点

25mm motor is the main trends and star product in the market, used on sunshade in homes, cars, boats, trains, coaches or airplanes etc. No wiring installation, max lifting 8kgs and electronic limit are their main features, enjoys excellent advantage of low noise, low power consumption and easy setting methods.

25mm直流可充电式卷帘管状电机内含长寿命可充电锂电池，具有免布线的特点，可接太阳能板，充电宝充电，或可充电适配器充电。电池一次充满可用3~6个月，电池寿命可达300次充放电循环。

Product performance 产品性能

- Stronger enough to lift most interior blinds
 - Li-ion battery 2500mAh inside for 3-6 months use
 - Obstacle detector protects blinds
 - Mini size for 38mm roller pipe
- 内置2500毫安锂电池，可供3-6个月使用
 - 力气足够大，可提升80%室内卷帘
 - 遇阻停止功能可保护帘布
 - 适用于38mm卷管



Dimension Drawing 外型尺寸



Inner Structure Picture 内部结构图



Specification 规格

型号 Model	力矩 Rated Torque N.m	转速 Rated Speed rpm	直径 Tube Diameter mm	电压 Rated voltage V	功率 Rated Power W	电流 Rated Current A	功能等级 Protection Degree IP22	行程圈数 Max Number of Turns ∞	长度 L1/L2 mm	工作时长 Working Time Month	电池容量 Battery Capacity mAh
FT25LEU-1.1/24	1.1	24	25	9	10	0.9	IP22	∞	430/420	3-6	2500
FT25LEU-1.5/24	1.5	24	25	12	12	1	IP22	∞	430/420	3-6	2500

FT25DS Motor

25mm mechanical DC bus blinds tubular motor
25mm 机械直流管状电机



DC motor



Mechanical limit



Features 产品特点

25mm mechanical DC tubular motor with its most stable and reliable feature, it is mainly used in bus and railway driver roller blinds, it is Conducted Emission (CE) approved under GB 18655/T-2018 and IEC 61373 (Railway applications - Rolling stock equipment - Shock and vibration tests) approved.

25mm机械型直流管状电机有12V和24V可选，主要应用于巴士和高铁驾驶室遮阳帘，高端版本可通过国标GB 18655/T-2018传导发射的要求，和通过国际电工要求的IEC 61373指令，即铁路应用-机车车辆设备-冲击和振动测试。

Product performance 产品性能

- Mechanical limit of max 30 turns
- Green 12V or 24V DC input

- 机械行程，铜质丝杆，最大运行30圈
- 直流12V/24V供电，绿色环保，供电方式多样



Dimension Drawing 外型尺寸



Inner Structure Picture 内部结构图

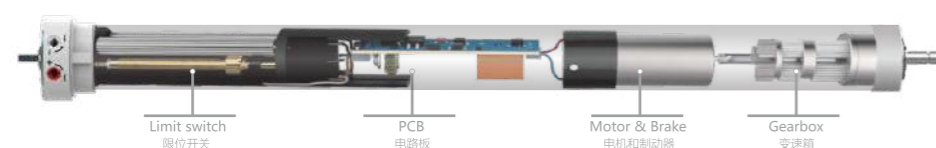

Specification 规格

型号 Model	力矩 Rated Torque	转速 Rated Speed	直径 Tube Diameter	电压 Rated voltage	功率 Rated Power	电流 Rated Current	功能等级 Protection Degree	行程圈数 Max Number of Turns	长度 L1/L2
	N.m	rpm	mm	V	W	A		Turn	mm
FT25DS-0.7/34(12V)	0.7	34	25	12/24	9	0.7/0.4	IP44	22	310/300
FT25DS-0.7/34(24V)	0.7	34	25	12/24	9	0.9/0.5	IP44	22	310/300

FT35TEW Motor

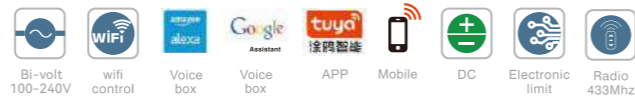

35mm Bi-volt WiFi tubular motor
35mm 宽电压WiFi智能管状电机



Features 产品特点

35mm Bi-volt WiFi tubular motors can be used in a wide range of input from 90V to 260V, which is more convenient especially for wide range voltage countries. The motor without heating protection, more wider application area.

35mm宽电压Wi-Fi电机应用领域广泛，尤其是双电压国家，比如南美等。电机无热保护问题，应用场所更加灵活。

Product performance 产品性能

- Wide input range of 100-240V, more easy for bi-volt countries and world wide using
 - WiFi chip inside for smart home applications, mobile app and voice boxes, such as Amazon Echo and Google Assistant etc
 - Suitable for high blinds, 8 meters minimum
 - Obstacle detector protects blinds
 - Limit setting by remote
- 100-240V宽电压供电，全球使用，无电压限制
 - 内置涂鸦WiFi智能芯片，可实现手机、语音音箱等智能连接
 - 高帘子适用
 - 遇阻停止功能可保护帘布
 - 遥控器设行程让安装调试更轻松



Dimension Drawing 外型尺寸

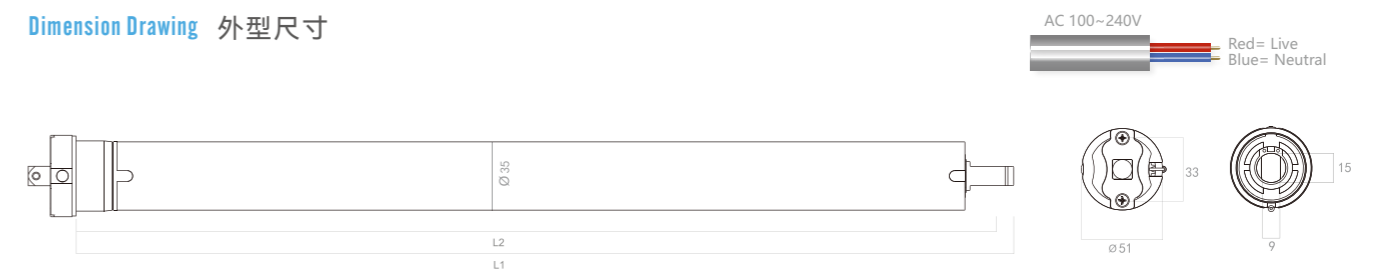

Inner Structure Picture 内部结构图



Specification 规格

型号 Model	力矩 Rated Torque	转速 Rated Speed	直径 Tube Diameter	电压 Rated voltage	功率 Rated Power	电流 Rated Current	功能等级 Protection Degree	行程圈数 Max Number of Turns	长度 L1/L2	工作时长 Working Time
	N.m	rpm	mm	V	W	A		Turn	mm	Minute
FT35TEW-6/20	6	20	35	100~240	60	5	IP44	No limit	451/440	No limit

FT35DM Motor

35mm DC mini manual override tubular motor
35mm 迷你手摇直流管状电机



DC motor

Manual override

Mechanical limit



PATENTED



Features 产品特点

35DM is a DC input with manual override motor, it maybe the world No.1 35mm motor with manual function. It is patented and used for RV awning, size motor but strong enough to drive more than 3 meters awnings.

35直流手摇电机，可能是全球第一款35mm直径带手摇功能的电机。专利设计，专为房车遮阳篷定制。尺寸小，却足以驱动宽度达3米的房车遮阳篷。

Product performance 产品性能

- Patented mini design special for RV awning
- DC 12V/24V input, awning still can be open by manual handcrank when power off
- Stronger enough for 95% RV awnings
- 专利产品，专为房车遮阳棚设计
- 直流12V或24V供电，手电一体（手摇柄 ϕ 6mm六边形）断电情况下仍能用手摇杆开启遮阳棚
- 力量足，可开启市场上95%的房车遮阳棚



Inner Structure Picture 内部结构图

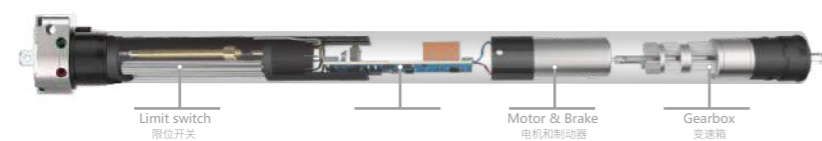

Limit switch
限位开关

Motor & Brake
电机和制动器

Gearbox
变速箱

Dimension Drawing 外型尺寸



Red positive +
Black negative -

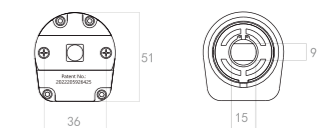

Specification 规格

型号 Model	力矩 Rated Torque	转速 Rated Speed	直径 Tube Diameter	电压 Rated voltage	功率 Rated Power	电流 Rated Current	功能等级 Protection Degree	行程圈数 Max Number of Turns	长度 L1/L2	工作时长 Working Time
	N.m	rpm	mm	V	W	A		Turn	mm	
FT35DM-10/10(12V)	10	10	35	12	60	5	IP44	30	510/499	No limit
FT35DM-10/10(24V)	10	10	35	24	60	2.5	IP44	30	510/499	No limit

FT35LE Motor

35mm Rechargeable roller blinds tubular motor
35mm 可充电式卷帘电机

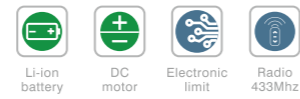

POWER SUPPLY MODE 供电方式

- Solution 1: AC/DC Adapter
Solution 2: Solar panel
Solution 3: Battery Bank
方案 1: 交流/直流 适配器
方案 2: 太阳能板
方案 3: 充电宝



Features 产品特点

35mm rechargeable tubular motor with waterproof charging port, can be used outside door, more stronger for heavy or wide blinds. 2500Amh for 6 month usage, and 5000Amh and LG battery is optional for ONE YEAR usage.

35mm 锂电电机的充电接口采用防水设计，可用于户外防风帘等，2500毫安电池充满可用6个月，还有5000毫安和LG品牌电池可供选择，充电频率可间隔1年之久。

Product performance 产品性能

- Li-ion battery 2500mAh inside for 3-6 months use
 - DC motor without heating problem let the blinds running longer distance
 - Obstacle detector protects blinds
 - Limit setting by remote let install more easy
- 内置2500毫安锂电池，可供3-6个月使用
 - 直流马达无热保护问题，窗帘运行时间和距离更长
 - 遇阻停止功能可保护帘布
 - 遥控器设行程让安装调试更轻松



Dimension Drawing 外型尺寸



Inner Structure Picture 内部结构图

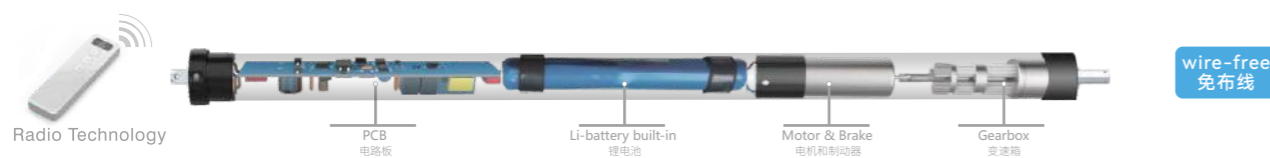

Specification 规格

型号 Model	力矩 Rated Torque	转速 Rated Speed	直径 Tube Diameter	电压 Rated voltage	功率 Rated Power	电流 Rated Current	功能等级 Protection Degree	行程圈数 Max Number of Turns	长度 L1/L2	工作时长 Working Time	电池容量 Battery Capacity
	N.m	rpm	mm	V	W	A		Turn	mm	Month	mAh
FT35LE-6/20	6	20	35	12	60	5	IP22	∞	642/631	2-4	2500

Product Advantage



-  Precision machinery
-  Mute bearing
-  Copper motor
-  Low noise tilt gear



Futai Lithium Motor		e24	
FT33DM-10110	10 r/min	5A	
10 Nm	12 V	50 W	IP 44
Mechanical Limit Manual Override			



CE  E24 UK CA
ISO9001:2015

-  zigbee
-  Voice box
-  Voice box
-  APP
-  Mobile

-  Li-ion battery
-  DC motor
-  Electronic limit
-  Radio 433Mhz
-  Bi-volt 100-240V
-  Manual override
-  wifi control
-  Mechanical limit

FT15LEU Motor

15mm rechargeable mosquito blinds motor
15mm 可充电式纱窗电机

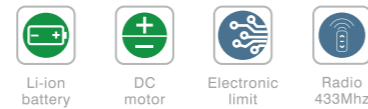

FT25CE Motor

25mm DC roller blinds tubular motor without battery
25mm 直流电源外置低功耗卷帘电机

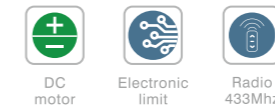

POWER SUPPLY MODE 供电方式

- Solution 1: AC/DC Adapter
Solution 2: Solar panel
Solution 3: Battery Bank
方案 1: 交流/直流 适配器
方案 2: 太阳能板
方案 3: 充电宝

- Li-ion battery 800mAh built-in for 2-4 months use
- Used for light blinds such as pleated or mosquito blinds
- Mini size for easily hidden, fit with minimum 17mm roller pipe
- 内置800毫安锂电池，充满后可供2-4个月使用
- 用于斑马帘或纱窗帘等轻质窗帘
- 尺寸小，隐藏性好，安装美观，可配最小17mm卷管

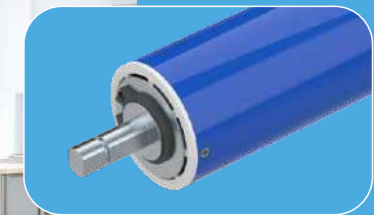

POWER SUPPLY MODE 供电方式

- Solution 1: AC/DC Adapter
Solution 2: Solar panel
Solution 3: Battery Bank
方案 1: 交流/直流 适配器
方案 2: 太阳能板
方案 3: 充电宝

- External battery connecting
- Stronger enough to lift max. 10m² fabric
- Obstacle detector to protect blinds
- Mini size for 38mm roller pipe
- 内置2500毫安锂电池，可供3-6个月使用
- 力气大，1.5N可最大提升10平米室内卷帘
- 遇阻停止功能可保护帘布
- 适用于38mm卷管



Inner Structure Picture 内部结构图



Inner Structure Picture 内部结构图

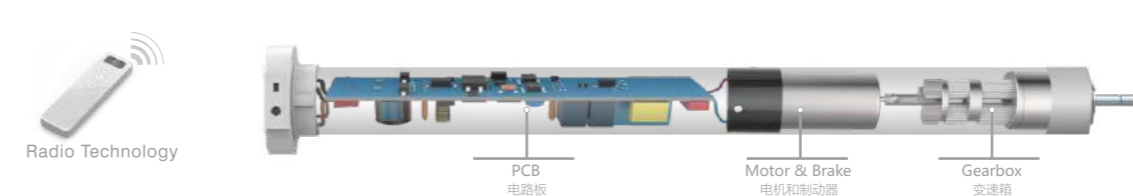

Dimension Drawing 外型尺寸



Specification 规格

型号 Model	力矩 Rated Torque	转速 Rated Speed	直径 Tube Diameter	电压 Rated voltage	功率 Rated Power	电流 Rated Current	功能等级 Protection Degree	行程圈数 Max Number of Turns	长度 L1/L2	工作时长 Working Time	电池容量 Battery Capacity
	N.m	rpm	mm	V	W	A		Turn	mm	Month	mAh
FT15LEU	0.3	44	15	9	7	0.78	IP22	∞	360/350	2-4	800

Dimension Drawing 外型尺寸



Specification 规格

型号 Model	力矩 Rated Torque	转速 Rated Speed	直径 Tube Diameter	电压 Rated voltage	功率 Rated Power	电流 Rated Current	功能等级 Protection Degree	行程圈数 Max Number of Turns	长度 L1/L2
	N.m	rpm	mm	V	W	A		Turn	mm
FT25CE-1.1/28	1.1	28	25	9	10	0.9	IP22	∞	310/300

FT25DB Motor

25mm bus blinds tubular motor
25mm 电子线控汽车窗帘管状电机

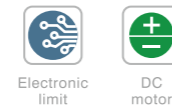

- Electronic limit for unlimited stroke
- Green 12V or 24V DC input
- 电子限位，无线行程
- 直流12V/24V供电，绿色环保，供电方式多样



Inner Structure Picture 内部结构图



Dimension Drawing 外型尺寸

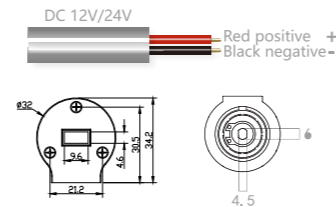
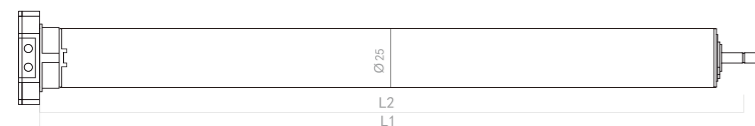

Specification 规格

型号 Model	力矩 Rated Torque	转速 Rated Speed	直径 Tube Diameter	电压 Rated voltage	功率 Rated Power	电流 Rated Current	功能等级 Protection Degree	行程圈数 Max Number of Turns	长度 L1/L2
	N.m	rpm	mm	V	W	A		Turn	mm
FT25DB-0.7/34(12V)	0.7	34	25	12	10	0.39	IP22	∞	310/300
FT25DB-0.7/34(24V)	0.7	34	25	24	10	0.68	IP22	∞	310/300



FT25LEZ Motor

25mm zigbee mobile and voice control rechargeable smart motor
25mm zigbee 语音和手机控制智能锂电池电机



- Tuya Zigbee chip inside for smart home connections mobile and voice control etc
- Mini size for 38mm roller pipe
- Obstacle detector to protect blinds
- Li-ion battery 2500mAh inside for 3-6 months use

- 内置涂鸦Zigbee智能芯片，轻松实现手机语音音箱等智能连接
- 内置2500毫安锂电池，可供3-6个月使用
- 遇阻停止功能可保护帘布
- 适用于38mm卷管



POWER SUPPLY MODE 供电方式

- Solution 1: AC/DC Adapter
- Solution 2: Solar panel
- Solution 3: Battery Bank
- 方案1: 交流/直流适配器
- 方案2: 太阳能板
- 方案3: 充电宝



Inner Structure Picture 内部结构图

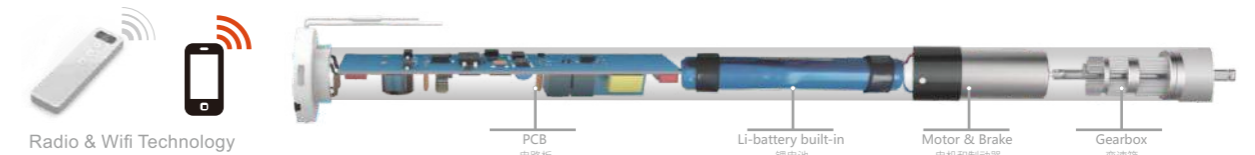

Dimension Drawing 外型尺寸

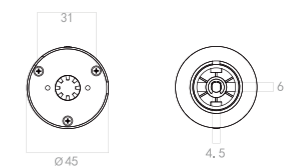

Specification 规格

型号 Model	力矩 Rated Torque	转速 Rated Speed	直径 Tube Diameter	电压 Rated voltage	功率 Rated Power	电流 Rated Current	功能等级 Protection Degree	行程圈数 Max Number of Turns	长度 L1/L2
	N.m	rpm	mm	V	W	A		Turn	mm
FT25LEZ-1.1/24	1.1	24	25	9	10	0.83	IP22	∞	454/444

FT25TE Motor

25mm rechargeable roller blinds tubular motor
25mm 可充电式卷帘电机

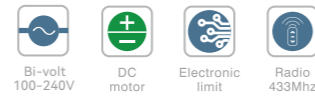

FT25TEW Motor

25mm wifi mobile and voice control tubular motor
25mm wifi语音和手机控制强电卷帘电机

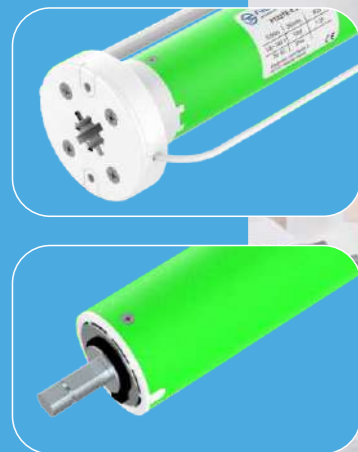
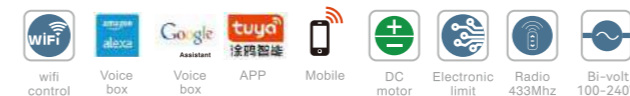

- Wide voltage 100 to 240V inputs make global applications easier
 - Stroke setting by transmitter makes installation more easy
 - Stronger enough to lift max. 10m fabric
 - Obstacle detector protects blinds
 - Unlimited stroke suitable for high blinds
- 100-240V宽电压输入使全球范围内使用更简便
 - 遇阻停止功能保护帘布
 - 无限行程可用于超高窗帘
 - 遥控器设行程让安装更轻松
 - 力气大, 1.5N可最大提升10平米室内卷帘

- WiFi chip inside for smart home connectings mobile and voice controls etc
- Wide voltage 100 to 240V inputs make global applications easier
- Unlimited stroke suitable for high blinds
- Obstacle detector protects blinds
- Stroke setting by transmitter makes installation more easy
- Stronger enough to lift max. 10m fabric

- 内置涂鸦WiFi智能芯片, 可实现手机语音音箱等智能连接
- 100-240V宽电压输入使全球范围内使用更简便
- 遇阻停止功能保护帘布
- 无限行程可用于超高窗帘
- 遥控器设行程让安装更轻松
- 力气大, 1.5N可最大提升10平米室内卷帘



Inner Structure Picture 内部结构图

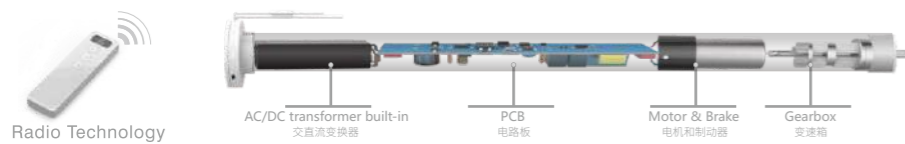

Dimension Drawing 外型尺寸



Specification 规格

型号 Model	力矩 Rated Torque	转速 Rated Speed	直径 Tube Diameter	电压 Rated voltage	功率 Rated Power	电流 Rated Current	功能等级 Protection Degree	行程圈数 Max Number of Turns	长度 L1/L2
	N.m	rpm	mm	V	W	A		Turn	mm
FT25TE-1.1/28	1.1	28	25	100~240	10	0.83	IP22	∞	430/420
FT25TE-1.5/28	1.5	28	25	100~240	12	1	IP22	∞	430/420



Inner Structure Picture 内部结构图



Dimension Drawing 外型尺寸



Specification 规格

型号 Model	力矩 Rated Torque	转速 Rated Speed	直径 Tube Diameter	电压 Rated voltage	功率 Rated Power	电流 Rated Current	功能等级 Protection Degree	行程圈数 Max Number of Turns	长度 L1/L2
	N.m	rpm	mm	V	W	A		Turn	mm
FT25TEW-1.1/28	1.1	28	25	100~240	10	0.83	IP22	∞	430/420
FT25TEW-1.5/28	1.5	28	25	100~240	12	1	IP22	∞	430/420

FT35DS Motor

35mm Mechanical DC tubular motor
35mm 机械直流管状电机

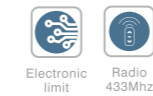
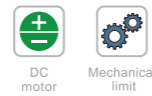

FT35E Motor

35mm Electronic tubular motor
35mm 电子型管状电机



- Mechanical limit of max 30 turns
- DC motor inside without heating problem can run longer time
- Green 12V or 24V DC input
- 机械行程，铜质丝杆，最大运行30圈，约4米
- 无热保护，运行时间长
- 直流12V/24V供电，绿色环保



- Unlimited stroke suitable for high blinds
- Obstacle detection function can protect blinds during running
- Limit setting by remote let install more easy
- 无限行程可适用于超高窗帘
- 遇阻停止功能保护帘布
- 遥控器设行程让安装调试更轻松



Inner Structure Picture 内部结构图

Inner Structure Picture 内部结构图

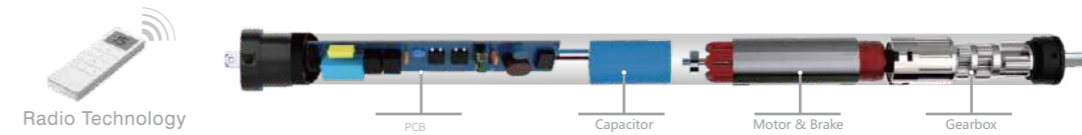
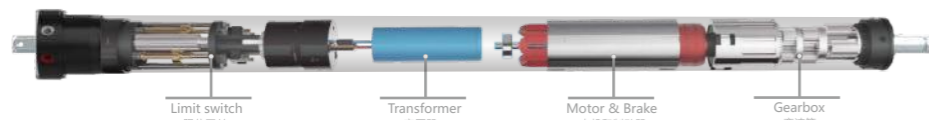

Dimension Drawing 外型尺寸



Dimension Drawing 外型尺寸



Specification 规格

型号 Model	力矩 Rated Torque	转速 Rated Speed	直径 Tube Diameter	电压 Rated voltage	功率 Rated Power	电流 Rated Current	功能等级 Protection Degree	行程圈数 Max Number of Turns	长度 L1/L2	工作时长 Working Time
	N.m	rpm	mm	V	W	A	IP44	Turn	mm	minute
FT35DS-10/10	10	10	35	12/24	60	5/2.5	IP44	30	577/566	No limit

Specification 规格

型号 Model	力矩 Rated Torque	转速 Rated Speed	直径 Tube Diameter	电压 Rated voltage	功率 Rated Power	电流 Rated Current	功能等级 Protection Degree	行程圈数 Max Number of Turns	长度 L1/L2	工作时长 Working Time
	N.m	rpm	mm	V	W	A	IP44	Turn	mm	minute
FT35E-6/28	6	28	35	230	121	0.57	IP44	∞	451/440	4
FT35E-10/17	10	17	35	230	121	0.57	IP44	∞	451/440	4
FT35E-13/14	13	14	35	230	121	0.57	IP44	∞	451/440	4

FT35EW Motor

35mm wifi mobile and voice control tubular motor
35mm wifi语音和手机控制智能管状电机

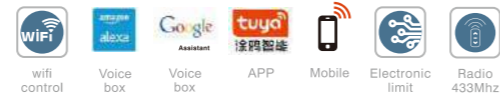

FT35S Motor

35mm Mechanical tubular motor
35mm 机械管状电机



- WiFi chip inside for smart home applications, mobile app and voice boxes, such as Amazon Echo and Google Assistant etc
 - Unlimited stroke suitable for high blinds
 - Obstacle detector protects blinds
 - Limit setting by remote let install more easy
- 内置涂鸦WiFi智能芯片，可实现手机、语音音箱等智能连接
无限行程可适用于超高窗帘
遇阻停止功能可保护帘布
遥控器设行程让安装调试更轻松



- Mechanical limit and 4 minutes running allows motor to run smoothly and long service life
- Work with manual switch or receiver & remote kit
- 机械行程，铜质丝杆，4分钟热保护，电机寿命长，运行稳定和翘板开关或遥控器套装配套使用



Inner Structure Picture 内部结构图

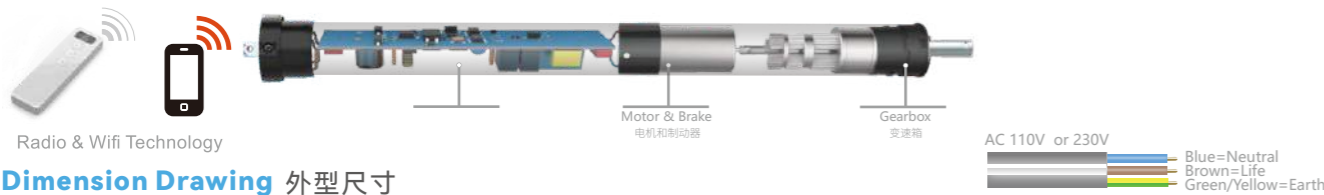

Dimension Drawing 外型尺寸

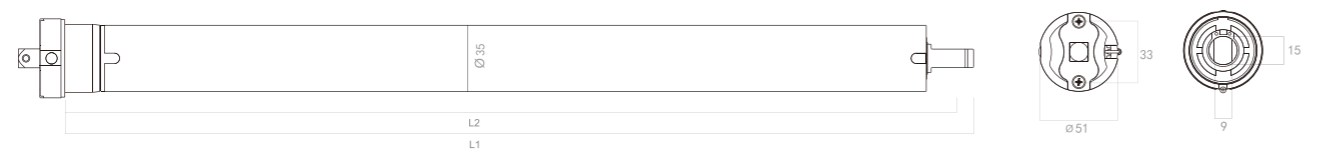

Specification 规格

型号 Model	力矩 Rated Torque N.m	转速 Rated Speed rpm	直径 Tube Diameter mm	电压 Rated voltage V	功率 Rated Power W	电流 Rated Current A	功能等级 Protection Degree IP44	行程圈数 Max Number of Turns Turn	长度 L1/L2 mm	工作时长 Working Time minute
FT35EW-6/28	6	28	35	230	121	0.57	IP44	30	451/440	4
FT35EW-10/17	10	17	35	230	121	0.57	IP44	30	451/440	4
FT35EW-13/14	13	14	35	230	121	0.57	IP44	30	451/440	4

Inner Structure Picture 内部结构图



Dimension Drawing 外型尺寸



Specification 规格

型号 Model	力矩 Rated Torque N.m	转速 Rated Speed rpm	直径 Tube Diameter mm	电压 Rated voltage V	功率 Rated Power W	电流 Rated Current A	功能等级 Protection Degree IP44	行程圈数 Max Number of Turns Turn	长度 L1/L2 mm	工作时长 Working Time minute
FT35S-6/28	6	28	35	230	121	0.53	IP44	30	457/446	4
FT35S-10/17	10	17	35	230	121	0.53	IP44	30	457/446	4
FT35S-13/14	13	14	35	230	121	0.53	IP44	30	457/446	4

FT35R Motor

35mm Mechanical radio tubular motor
35mm 内置接收型管状电机

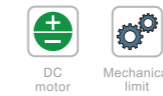

FT45DS Motor

45mm mechanical DC tubular motor
45mm 机械直流管状电机



- Receiver inside for easy wiring and installation
- Mechanical limit and 4 minutes running time keep motor stable and long servicing life
- 内置接收器，接线和安装更简便
- 机械行程，铜质丝杆，4分钟热保护电机寿命更长，运行更稳定



- Mechanical limit of max 22 turns
- DC motor without heating issue, motor run longer time continuously
- 12V or 24V DC input, can be powered by solar panel and battery wand

- 机械行程，铜质精细丝杆，最大运行22圈
- 绿色环保，无热保护，持续运行时间长
- 直流12V/24V输入，可采用太阳能和锂电池棒供电

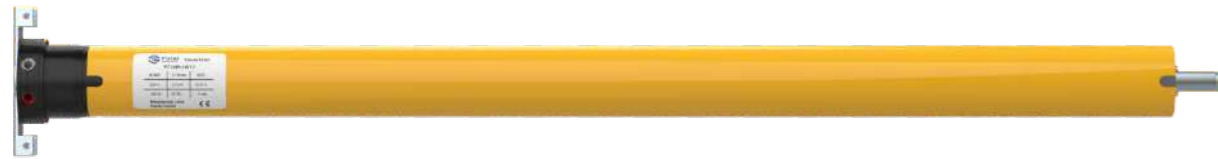

Inner Structure Picture 内部结构图

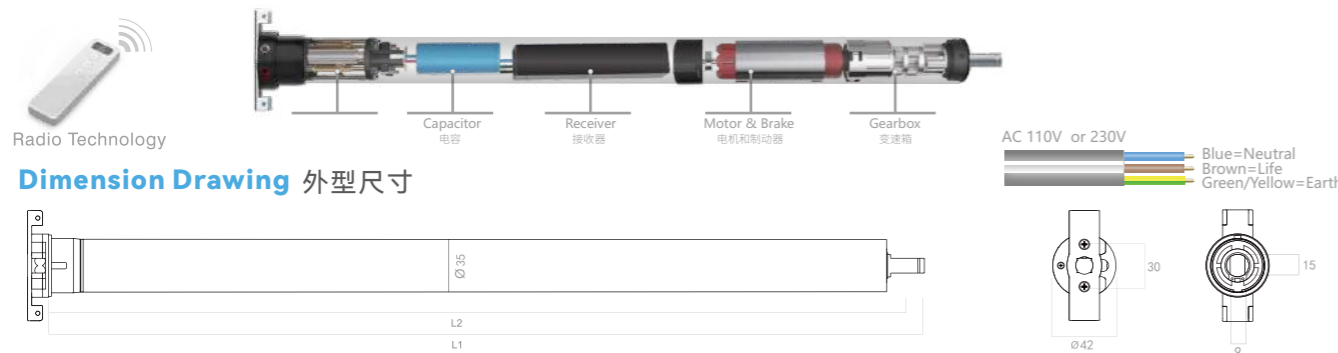

Specification 规格

型号 Model	力矩 Rated Torque	转速 Rated Speed	直径 Tube Diameter	电压 Rated voltage	功率 Rated Power	电流 Rated Current	功能等级 Protection Degree	行程圈数 Max Number of Turns	长度 L1/L2	工作时长 Working Time
	N.m	rpm	mm	V	W	A		Turn	mm	minute
FT35R-6/28	6	28	35	230	121	0.53	IP44	30	577/566	4
FT35R-10/17	10	17	35	230	121	0.53	IP44	30	577/566	4
FT35R-13/14	13	14	35	230	121	0.53	IP44	30	577/566	4



Inner Structure Picture 内部结构图



Specification 规格

型号 Model	力矩 Rated Torque	转速 Rated Speed	直径 Tube Diameter	电压 Rated voltage	功率 Rated Power	电流 Rated Current	功能等级 Protection Degree	行程圈数 Max Number of Turns	长度 L1/L2
	N.m	rpm	mm	V	W	A		Turn	mm
FT45DS-20/10	20	10	45	12/24	27	2.3/1.1	IP44	22	646/625
FT45DS-40/8	40	8	45	12/24	78	6.5/3.3	IP44	22	646/625
FT45DS-50/6	50	6	45	12/24	80	6.7/3.3	IP44	22	646/625

FT35TE Motor

35mm bi-volt electronic tubular motor
35mm 宽电压电子管状电机

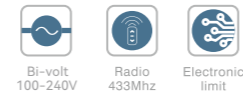

FT45EW Motor

45mm wifi mobile and voice control tubular motor
45mm wifi语音和手机控制智能管状电机



- Wide input range of 100-240V, more easy for bi-volt countries and worldwide using
- Unlimited stroke suitable for high blinds
- without heating problem, can run longer time
- 100-240V宽电压供电, 全球使用, 无电压限制
- 无限行程可适用于超高窗帘
- 无热保护问题, 窗帘运行时间更长

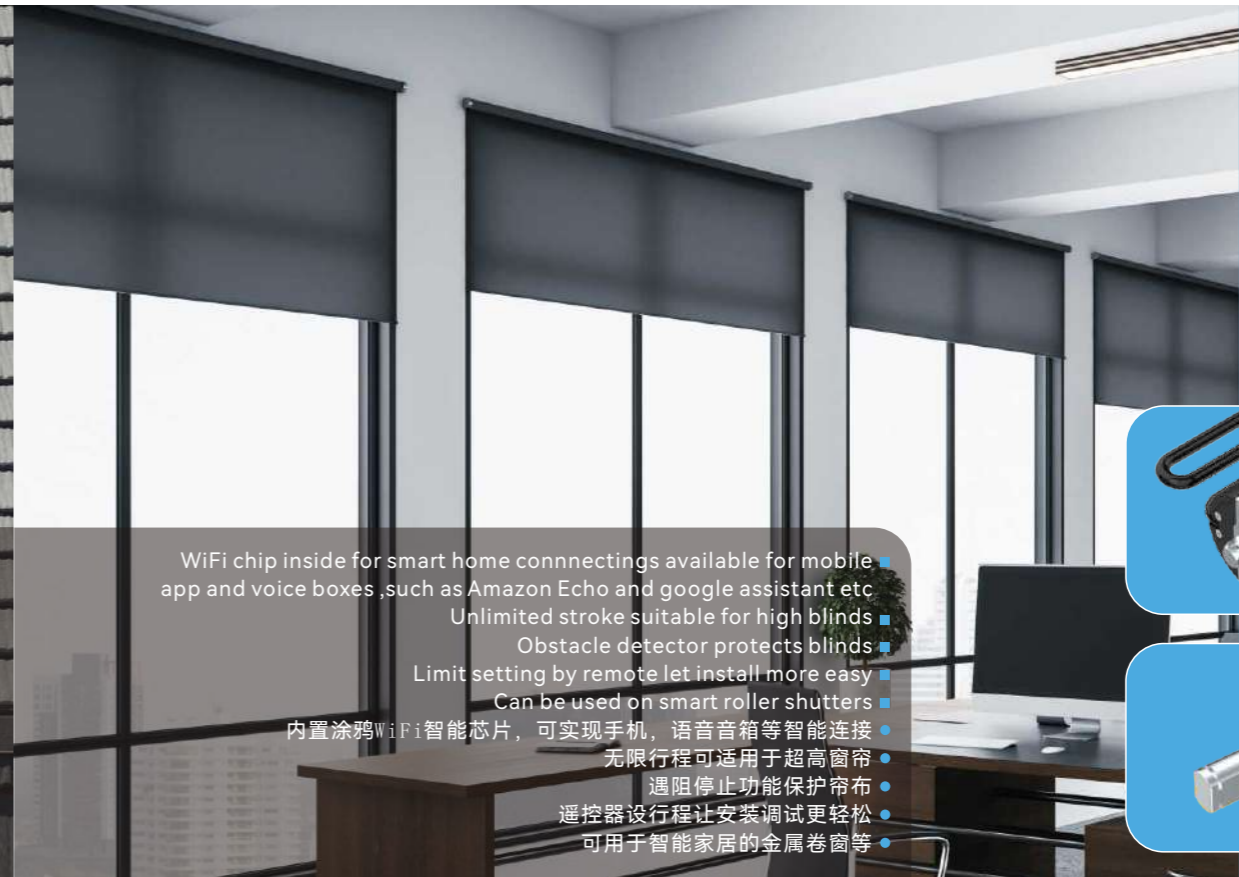

- WiFi chip inside for smart home connectings available for mobile app and voice boxes, such as Amazon Echo and google assistant etc
- Unlimited stroke suitable for high blinds
- Obstacle detector protects blinds
- Limit setting by remote let install more easy
- Can be used on smart roller shutters
- 内置涂鸦WiFi智能芯片, 可实现手机, 语音音箱等智能连接
- 无限行程可适用于超高窗帘
- 遇阻停止功能保护帘布
- 遥控器设行程让安装调试更轻松
- 可用于智能家居的金属卷帘等



Inner Structure Picture 内部结构图



Inner Structure Picture 内部结构图

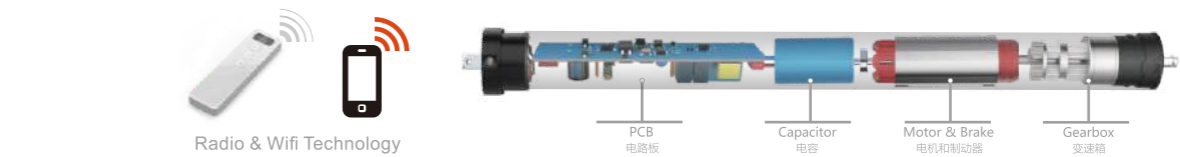

Dimension Drawing 外型尺寸

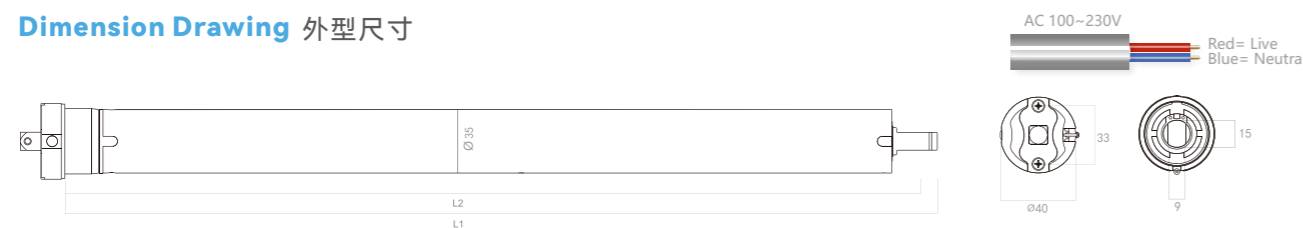

Dimension Drawing 外型尺寸

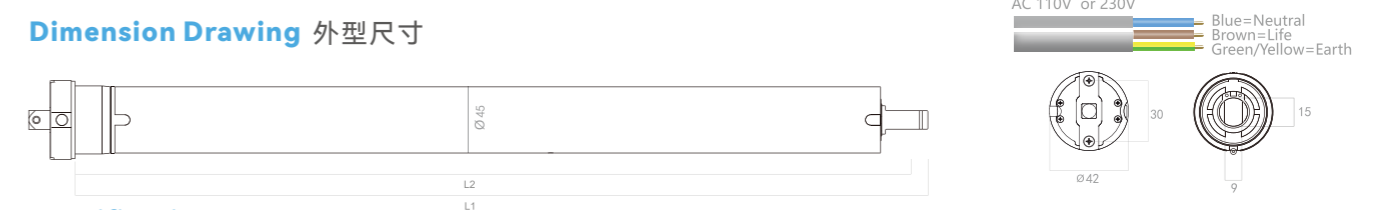

Specification 规格

型号 Model	力矩 Rated Torque	转速 Rated Speed	直径 Tube Diameter	电压 Rated voltage	功率 Rated Power	电流 Rated Current	功能等级 Protection Degree	行程圈数 Max Number of Turns	长度 L1/L2	工作时长 Working Time
	N.m	rpm	mm	V	W	A		Turn	mm	Minute
FT35TE-6/20	6	20	35	100~240	60	5.7	IP22	No limit	451/440	No limit

Specification 规格

型号 Model	力矩 Rated Torque	转速 Rated Speed	直径 Tube Diameter	电压 Rated voltage	功率 Rated Power	电流 Rated Current	功能等级 Protection Degree	行程圈数 Max Number of Turns	长度 L1/L2	工作时长 Working Time
	N.m	rpm	mm	V	W	A		Turn	mm	Minute
FT45EW-20/15	20	15	45	230	205	0.89	IP44	22	697/476	4
FT45EW-50/12	50	12	45	230	205	0.64	IP44	22	441/420	4

FT45DM Motor

45mm manual DC tubular motor
45mm 手摇直流管状电机



FT45R Motor

45mm mechanical radio tubular motor
45mm 内置接收型管状电机



- Small size for RV awning
- DC 12V/24V input, manual handcrank function in case power off
- Strong enough for 99% RV awnings
- 小尺寸专为房车遮阳棚定制
- 直流12V或24V供电，手电一体（手摇柄 $\phi 8$ mm六边形）断电情况下仍能用手摇杆开启遮阳棚
- 力量足，可开启市场上99%的房车遮阳棚



- Receiver inside for easy wiring and installation
- Mechanical limit and 4 minutes thermal protection
- Can be used on lifting curtains or roller shutters in villa or theater backdrop
- 内置接收器，接线和安装更简便
- 机械行程，铜质丝杆，4分钟热保护
- 可用于电动升降帘，金属卷闸窗等



Inner Structure Picture 内部结构图

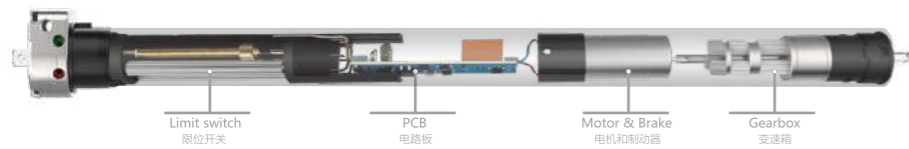

Limit switch 限位开关
PCB 电路板
Motor & Brake 电机和制动器
Gearbox 变速箱

DC 12V/24V
Red positive +
Black negative -

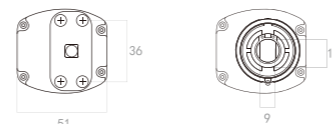

Dimension Drawing 外型尺寸



Specification 规格

型号 Model	力矩 Rated Torque	转速 Rated Speed	直径 Tube Diameter	电压 Rated voltage	功率 Rated Power	电流 Rated Current	功能等级 Protection Degree	行程圈数 Max Number of Turns	长度 L1/L2
	N.m	rpm	mm	V	W	A		Turn	mm
FT45DM-20/10	20	10	45	12	28	2.33	IP44	22	541/530



Inner Structure Picture 内部结构图

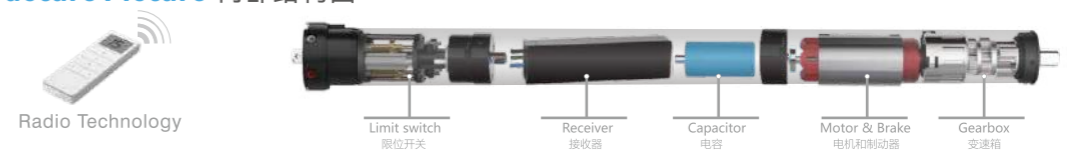

Radio Technology

Limit switch 限位开关
Receiver 接收器
Capacitor 电容
Motor & Brake 电机和制动器
Gearbox 变速箱

Dimension Drawing 外型尺寸



AC 110V or 230V
Blue=Neutral
Brown=Life
Green/Yellow=Earth

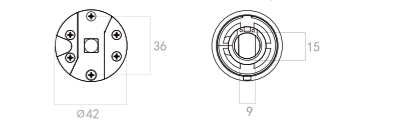

Specification 规格

型号 Model	力矩 Rated Torque	转速 Rated Speed	直径 Tube Diameter	电压 Rated voltage	功率 Rated Power	电流 Rated Current	功能等级 Protection Degree	行程圈数 Max Number of Turns	长度 L1/L2	工作时长 Working Time
	N.m	rpm	mm	V	W	A		Turn	mm	Minute
FT45R-20/15	20	15	45	230	145	0.64	IP44	22	597/586	4
FT45R-40/15	40	15	45	230	198	0.86	IP44	22	597/586	4
FT45R-50/12	50	12	45	230	205	0.89	IP44	22	597/586	4

FT45E Motor

45mm electronic tubular motor
45mm 电子型管状电机

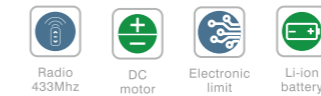
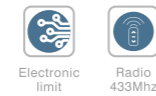

FT45LE Motor

45mm rechargeable roller blinds tubular motor
45mm 可充电式卷帘电机



- Unlimited stroke suitable for high blinds
 - Obstacle detection function can protect blinds during running
 - Limit setting by remote let install more easy
 - Can be used on intelligent roller shutters
- 无限行程可适用于超高窗帘
 - 遇阻停止功能可保护帘布
 - 遥控器设行程让安装调试更轻松
 - 可用于智能金属卷帘窗



- Li-ion battery 2500mAh inside for 3-6 months use
 - DC motor without heating problem let the blinds running longer distance
 - Obstacle detector protects blinds
 - Limit setting by remote let install more easy
 - Can be used on roof vent roller shutters, powered by solar panel
- 内置2500毫安锂电池，可供3-6个月使用
 - 直流马达无热保护问题，窗帘运行时间和距离更长
 - 遇阻停止功能可保护帘布
 - 遥控器设行程让安装调试更轻松
 - 可用于房顶气窗，户外防风帘等，可用太阳能板供电



Inner Structure Picture 内部结构图

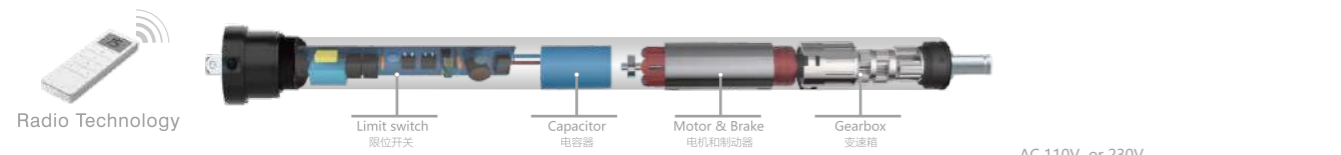

Dimension Drawing 外型尺寸



Specification 规格

型号 Model	力矩 Rated Torque	转速 Rated Speed	直径 Tube Diameter	电压 Rated voltage	功率 Rated Power	电流 Rated Current	功能等级 Protection Degree	行程圈数 Max Number of Turns	长度 L1/L2	工作时长 Working Time
	N.m	rpm	mm	V	W	A		Turn	mm	Minute
FT45E-20/15	20	15	45	230	205	0.89	IP44	∞	497/476	4
FT45E-50/12	50	12	45	230	145	0.64	IP44	∞	497/476	4



Inner Structure Picture 内部结构图

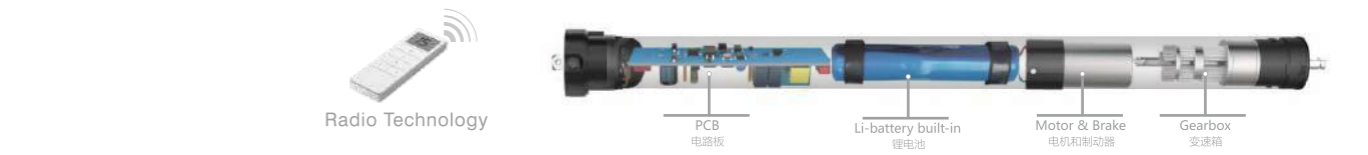

Dimension Drawing 外型尺寸



Specification 规格

型号 Model	力矩 Rated Torque	转速 Rated Speed	直径 Tube Diameter	电压 Rated voltage	功率 Rated Power	电流 Rated Current	功能等级 Protection Degree	行程圈数 Max Number of Turns	长度 L1/L2	工作时长 Working Time
	N.m	rpm	mm	V	W	A		Turn	mm	Minute
FT45LE-20/10	20	10	45	12	30	2.5	IP22	∞	640/619	3-6

FT45S Motor



45mm mechanical tubular motor
45mm 机械管状电机



FT45M Motor

45mm mechanical manual tubular motor
45mm 机械手摇管状电机



- Mechanical limit and 4 minutes thermal protection
 - Work with manual switch or remote kit
 - Can be used on electric roller shutters
- 机械行程，铜质丝杆，4分钟热保护
 - 和翘板开关或遥控器套装配套使用
 - 可用于电动卷帘窗等



- Mechanical limit and 4 minutes thermal protection
 - Manual handcrank function in case power off
 - Work with manual switch or remote kit
 - Can be used in home garage doors
- 机械行程，铜质丝杆，4分钟热保护
 - 和翘板开关或遥控器套装配套使用
 - 手电一体（手摇柄 $\phi 8$ mm六边形）断电情况下仍能手摇开启车库门等自动门
 - 可用于小型车库门等



Inner Structure Picture 内部结构图

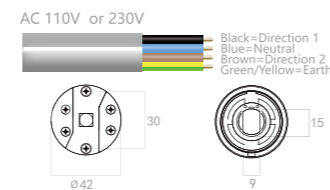
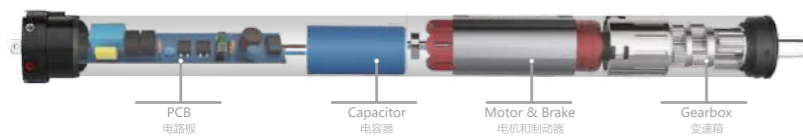

Dimension Drawing 外型尺寸



Specification 规格

型号 Model	力矩 Rated Torque N.m	转速 Rated Speed rpm	直径 Tube Diameter mm	电压 Rated voltage V	功率 Rated Power W	电流 Rated Current A	功能等级 Protection Degree IP44	行程圈数 Max Number of Turns Turn	长度 L1/L2 mm	工作时长 Working Time Minute
FT45S-20/15	20	15	45	230	145	2.05	IP44	22	466/445	4
FT45S-30/15	30	15	45	230	145	0.83	IP44	22	466/445	4
FT45S-40/15	40	15	45	230	145	0.86	IP44	22	466/445	4
FT45S-50/15	50	12	45	230	145	0.89	IP44	22	466/445	4



Inner Structure Picture 内部结构图

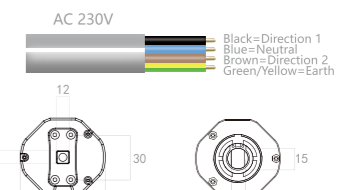
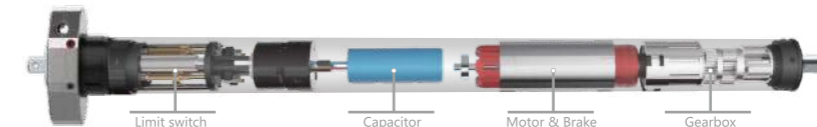

Dimension Drawing 外型尺寸

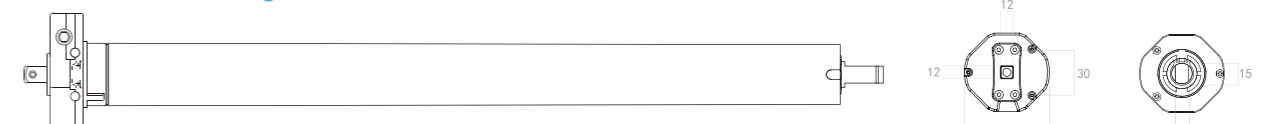

Specification 规格

型号 Model	力矩 Rated Torque N.m	转速 Rated Speed rpm	直径 Tube Diameter mm	电压 Rated voltage V	功率 Rated Power W	电流 Rated Current A	功能等级 Protection Degree IP44	行程圈数 Max Number of Turns Turn	长度 L1/L2 mm
FT45M-30/15	30	15	45	230	191	0.83	IP44	22	586/575
FT45M-40/15	40	15	45	230	198	0.86	IP44	22	586/575
FT45M-50/12	50	12	45	230	205	0.89	IP44	22	586/575

FT45MR Motor

45mm mechanical radio tubular motor
45mm 机械内置接收型管状电机

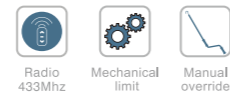

FT59M Motor

59mm mechanical manual tubular motor
59mm 机械手摇管状电机



- Mechanical limit and 4 minutes thermal protection
- Manual handcrank function in case power off
- Receiver inside for easy wiring and installation work with a remote
- Can be used on electric awning

- 机械行程，铜质丝杆，4分钟热保护
- 手电一体（手摇柄ø8mm六边形），断电情况下仍能手摇开启车库门等自动门
- 内置接收器，接线和安装更简便，和遥控器配套使用
- 可用于电动遮阳棚等



- Mechanical limit and 4 minutes thermal protection
- Manual handcrank function in case power off
- Work with manual switch or remote kit
- work for garage doors or industrial doors

- 机械行程，铜质丝杆，4分钟热保护
- 和翘板开关或遥控器套装配套使用
- 手电一体（手摇柄ø8mm六边形），断电情况下仍能手摇开启车库门等自动门
- 可用于车库门，工业门等



Inner Structure Picture 内部结构图



Radio Technology

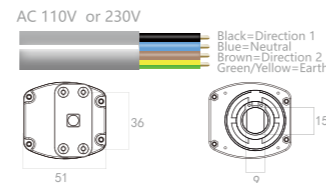
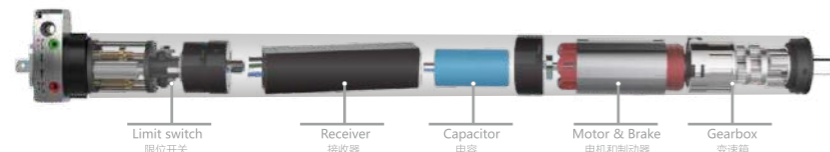

Dimension Drawing 外型尺寸



Specification 规格

型号 Model	力矩 Rated Torque	转速 Rated Speed	直径 Tube Diameter	电压 Rated voltage	功率 Rated Power	电流 Rated Current	功能等级 Protection Degree	行程圈数 Max Number of Turns	长度 L1/L2	工作时长 Working Time
	N.m	rpm	mm	V	W	A		Turn	mm	Minute
FT45MR-30/15	30	15	45	230	191	0.83	IP44	22	692/681	4
FT45MR-40/15	40	15	45	230	198	0.86	IP44	22	692/681	4
FT45MR-50/15	50	12	45	230	205	0.89	IP44	22	692/681	4



Inner Structure Picture 内部结构图

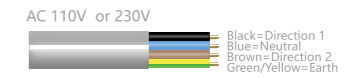
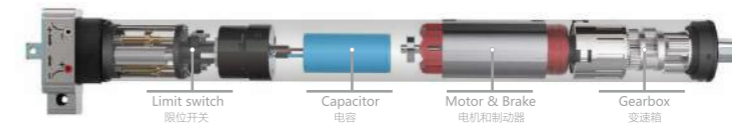

Dimension Drawing 外型尺寸



Specification 规格

型号 Model	力矩 Rated Torque	转速 Rated Speed	直径 Tube Diameter	电压 Rated voltage	功率 Rated Power	电流 Rated Current	功能等级 Protection Degree	行程圈数 Max Number of Turns	长度 L1/L2
	N.m	rpm	mm	V	W	A		Turn	mm
FT59M-80/15	80	15	59	230	330	1.43	IP44	22	586/575
FT59M-100/12	100	12	59	230	345	1.52	IP44	22	586/575
FT59M-120/9	120	9	59	230	350	1.56	IP44	22	586/575
FT59M-140/7	140	7	59	230	403	1.75	IP44	22	586/575

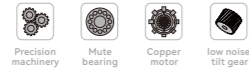

For FT15 Tubular Motor

TUBE	CROWN	DRIVE ADAPTER
T17 Aluminun 	C17 Plastic 	D17 Rubber+Plastic
T30 Aluminun 	C30 Rubber 	D30 Rubber+Plastic

For FT25 Tubular Motor

TUBE	CROWN	DRIVE ADAPTER
T28 Aluminun 	CROWN NO NEED	D28 Plastic
T35 Aluminun 	C35 Plastic 	D35 Plastic
T38 Aluminun 	C38-1 Plastic 	D38-1 Plastic

For FT25 Tubular Motor

TUBE	CROWN	DRIVE ADAPTER
T38 Aluminun 	C38-2 Rubber 	D38-2 Plastic
T38 Aluminun 	C38-3 Plastic 	D38-3 Rubber
T40 Aluminun 	C40 Plastic 	D40 Plastic <p>Customized</p>

IDLERS AND BRACKETS

W30-2 Plastic 	W38-1 Composite 	W38-2 Composite 	W38-3 Composite
B01-A Cold Rolled Plate 	B01-B Cold Rolled Plate 	B02-A Cold Rolled Plate 	B02-B Cold Rolled Plate
B03-A Cold Rolled Plate 	B03-B Cold Rolled Plate 	B06-A Cold Rolled Plate 	B06-B Cold Rolled Plate

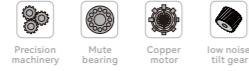

TUBE		CROWN		DRIVE ADAPTER	
T40-1 Aluminun		C40-1 Plastic		D40-1 Plastic	
T40-2 Aluminun		C40-2 Rubber		D40-2 Plastic	
T47 Aluminun		C47 Plastic		D47 Plastic	
T50 Aluminun		C50 Plastic		D50 Plastic	
T50-1 Aluminun		C50-1 Plastic		D50-1 Plastic	
T55 Aluminun		C55 Plastic		D55 Plastic	

IDLERS AND BRACKETS		
B03-A Cold Rolled Plate	B03-B Cold Rolled Plate	B04-A Cold Rolled Plate
B04-B Cold Rolled Plate	B05-A Cold Rolled Plate	B05-B Cold Rolled Plate
B10 Cold Rolled Plate	W37 Composite	W40 Composite
W47 Cold Rolled Plate	W47-1 Composite	W50 Composite
W50-1 Cold Rolled Plate	W50-2 Composite	W55 Composite

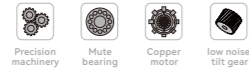

TUBE		CROWN		DRIVE ADAPTER			
T60 Aluminum		C60-1 Plastic		D60-1 Plastic			
T60 Aluminum		C60-2 Rubber		D60-2 Plastic			
T63 Aluminum		C63 Plastic		D63 Plastic			
T70 Aluminum		C70 Plastic		D70 Aluminum			
CROWN		DRIVE ADAPTER		CROWN		DRIVE ADAPTER	
C55-1 Plastic		D55-1 Plastic		C55-2 Plastic		D55-2 Plastic	
C60-4 Plastic		D60-4 Plastic		C50-2 Plastic		D50-2 Plastic	

CROWN		DRIVE ADAPTER		CROWN		DRIVE ADAPTER	
C60-1 Plastic		D60-1 Plastic		C60-3 Plastic		D60-3 Plastic	
C60-5 Plastic		D60-5 Plastic		C60-6 Plastic		D60-6 Plastic	
C60-7 Plastic		D60-7 Plastic		C67-1 Plastic		D67-1 Plastic	
C70 Plastic		D70 Aluminum		C72-1 Plastic		D72-1 Plastic	
C72-2 Plastic		D72-2 Plastic		C80-1 Plastic		D80-1 Plastic	
C80-2 Plastic		D80-2 Plastic					

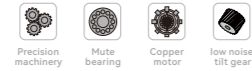

For FT45 Tubular Motor

Hand-hold transmitter

IDLERS AND BRACKETS

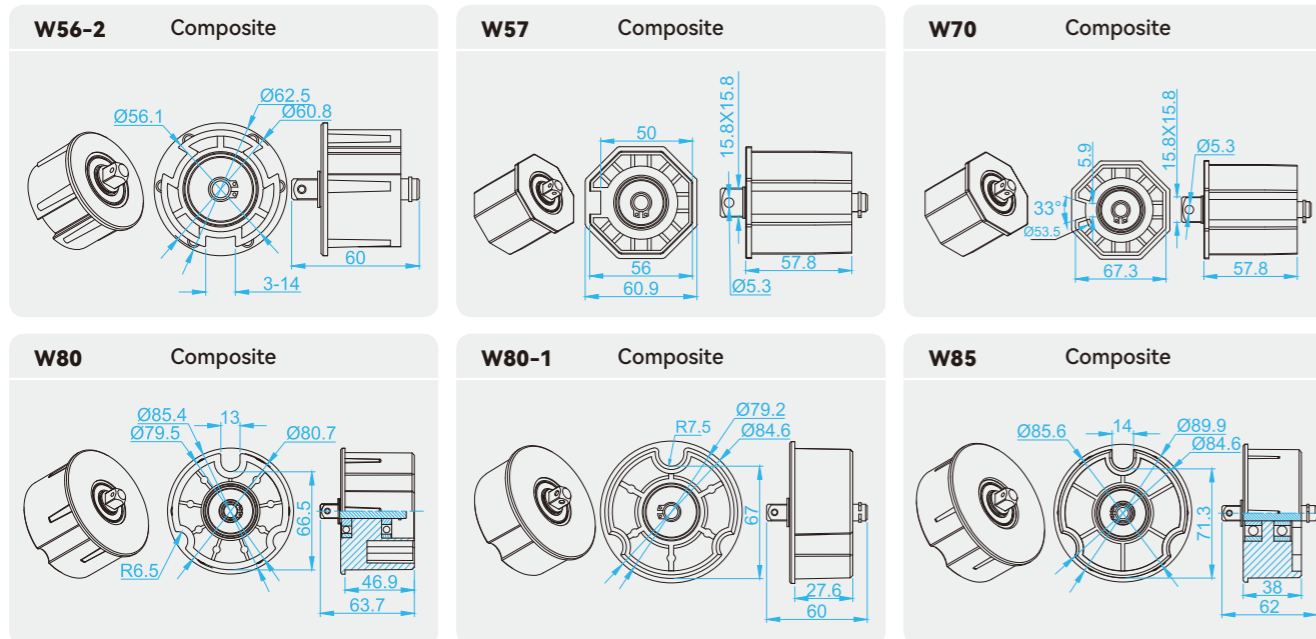

For FT59 Tubular Motor

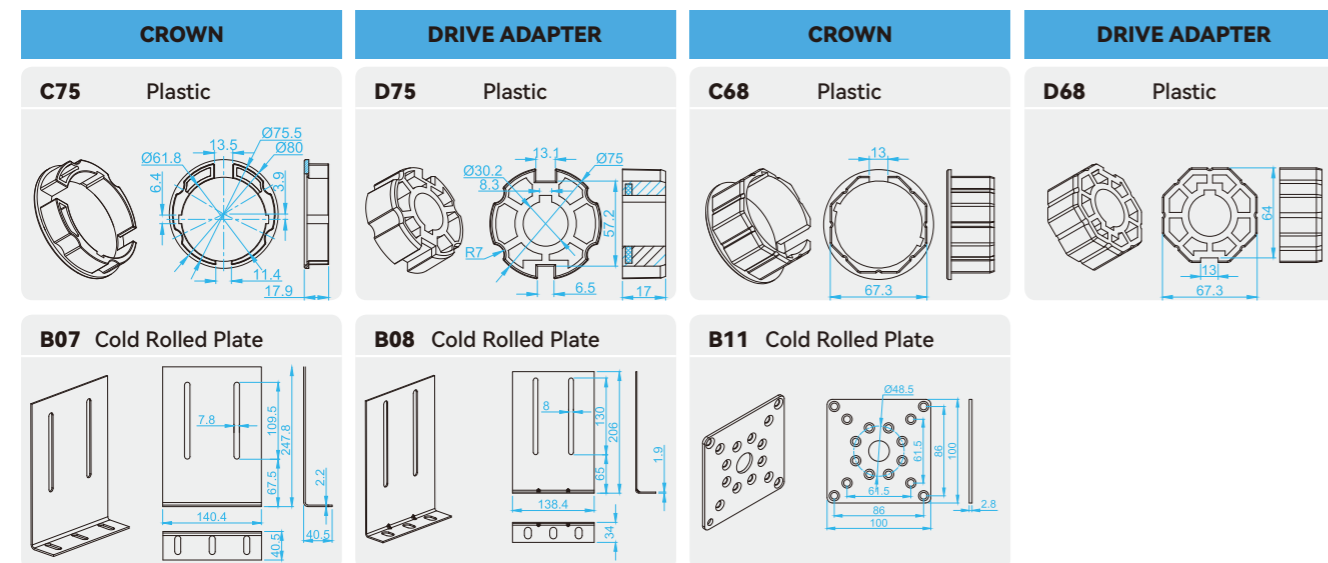

FC27

Single channel



FC28

Fifteen-channel



FC29

Five-channel



FC30

Fifteen-channel



FC31

Single channel



FC32

Double-channel



FC33

Single channel



FC34

Double-channel



FC21

Single channel



FC22

Five-channel



FC25

Fifteen-channel