

NT90T (T91)



32.4×27.5×28



32.4×27.5×20

UL US E174722

R50126373

Features

- Small size, light weight.
- Low coil power consumption, heavy contact load.
- Strong anti-shock and anti-vibration, high reliability, long life.
- Suitable for automobile, machine, electronic equipment, air conditioner and household appliances applications.
- PC board mounting and direct insert mounting available.

Ordering Information

NT90T H L A S 12 C B 0.9
 1 2 3 4 5 6 7 8 9

1 Part number: NT90T、NT90T ₂	6 Coil rated voltage(V): AC:12,24,110,120,220,240,277 DC:3,5,6,9,12,15,18,24,48,110
2 Load: H:30A; N:40A	7 Contact material: S: AgSnO ₂ ; C:AgCdO
3 High: NIL: Standard; L: Low profile type	8 Resist heat class: B:130℃ F:155℃
4 Contact arrangement: A:1A; B:1B; C:1C	9 Coil power: 0.6:0.6W; 0.9:0.9W 2:2VA
5 Enclosure: S: Wash tight ; D: Dust protected; E: Flux proof	

Contact Data

Contact Arrangement	1A(SPSTBNO) 1B(SPSTNC) 1C(SPDT(B-M))
Contact Material	AgSnO ₂ AgCdO
Contact Rating (Resistive)	NO:30A/240VAC,14VDC; NC:20A/240VAC;30A/14VDC NO:40A/240VAC,30VDC; NC:30A/240VAC,30VDC (0.9W) NO:30A/277VAC;NC:20A/277VAC Motor Load: NO:2HP 250VAC ; NC:1.5HP 250VAC TV-5 5A/280VAC(Ballast)
Max. Switching Power	1200W 7200VA (10000VA)
Max. Switching Voltage	30VDC 280VAC Max. Switching Current:40A
Contact Resistance	≤30mΩ Item 4.12 of IEC 61810-7
Operation Life	Electrical 1×10 ⁵ Item 4.30 of IEC 61810-7
	Mechanical 1×10 ⁷ Item 4.31 of IEC 61810-7

Coil Parameter

AC Coil Parameter									
Dash numbers	Rated voltage VDC		Rated current mA	Coil resistance Ω ±10%	Pick-up voltage VAC(max) (75%of rated voltage)	Drop-out voltage VAC(min) (30%of rated voltage)	Coil power VA	Operate time ms	Release time ms
	Rated	Max							
012AC	12	15.6	166.6	27	9.0	3.6	2VA	—	—
024AC	24	31.2	83.3	120	18.0	7.2			
110AC	110	143	18.1	2360	82.5	33.0			
120AC	120	156	16.6	3040	90.0	36.0			
220AC	220	286	9.1	13490	165.0	66.0			
240AC	240	312	8.3	15740	180	72			
277AC	277	360.1	7.2	20300	207.8	83.1			

CAUTION: 1.The use of any coil voltage less than the rated coil voltage will compromise the operation of the relay.
 2.Pickup and release voltage are for test purposes only and are not to be used as design criteria.

Coil Parameter

DC Coil Parameter								
Dash numbers	Coil voltage V		Coil resistance $\Omega \pm 10\%$	Pick-up voltage VDC(max) (75% of rated voltage)	Drop-out voltage VDC(min) (10% of rated voltage)	Coil power W	Operate time ms	Release time ms
	Rated	Max.						
003-900	3	3.9	10	2.25	0.3	0.9	≤ 15	≤ 10
005-900	5	6.5	28	3.75	0.5			
006-900	6	7.8	40	4.50	0.6			
009-900	9	11.7	90	6.75	0.9			
012-900	12	15.6	160	9.00	1.2			
015-900	15	19.5	250	10.25	1.5			
018-900	18	23.4	360	13.50	1.8			
024-900	24	31.2	640	18.00	2.4			
048-900	48	62.4	2560	36.00	4.8			
110-900	110	143	13445	82.50	11.0			
003-600	3	3.9	15	2.25	0.3	0.6	≤ 15	≤ 10
005-600	5	6.5	42	3.75	0.5			
006-600	6	7.8	60	4.50	0.6			
009-600	9	11.7	135	6.75	0.9			
012-600	12	15.6	240	9.00	1.2			
015-600	15	19.5	375	10.25	1.5			
018-600	18	23.4	540	13.50	1.8			
024-600	24	31.2	960	18.00	2.4			
048-600	48	62.4	3840	36.00	4.8			
110-600	110	143	20167	82.50	11.0			

CAUTION: 1.The use of any coil voltage less than the rated coil voltage will compromise the operation of the relay.
2.Pickup and release voltage are for test purposes only and are not to be used as design criteria.

Characteristics

Insulation Resistance	1000M Ω min (at 500VDC)	Item 4.11 of IEC 61810-7
Dielectric Strength Between Contacts Between Contact and Coil	50Hz 1500V 50Hz 2500V	Item 4.9 of IEC 61810-7 Item 4.9 of IEC 61810-7
Shock Resistance	Functional: 98m/s ² 11ms	Item 4.26 of IEC 61810-7
	Destructive: 980m/s ² 11ms	Item 4.26 of IEC 61810-7
Vibration Resistance	10Hz~55Hz Double amplitude 1.5mm	Item 4.28 of IEC 61810-7
Terminals Strength	10N	Item 4.24 of IEC 61810-7
Ambient Temperature	-55 $^{\circ}$ C~85 $^{\circ}$ C	
Relative Humidity	5% to 85%	Item 4.16 of IEC 61810-7
Mass	31g (Low Profile Type) 35g	Item 4.7 of IEC 61810-7

Dimensions

mm

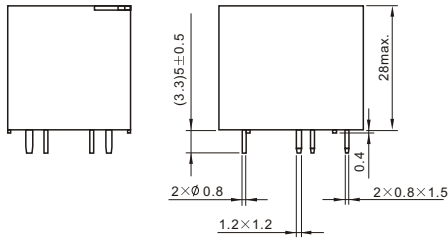

NT90T

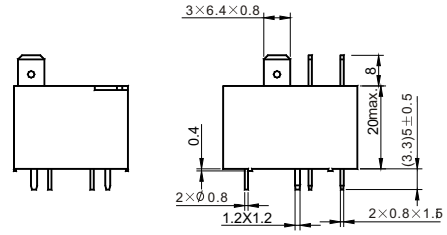

NT90TL

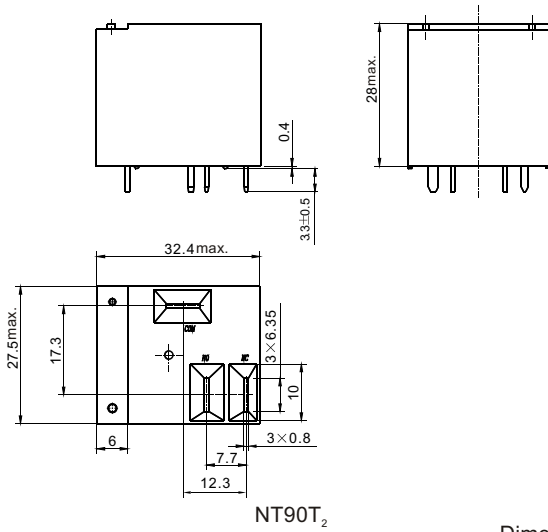
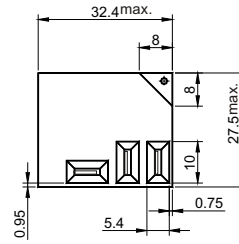
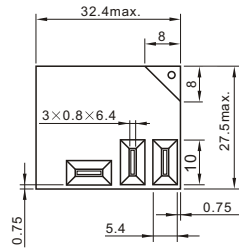

NT90T₂

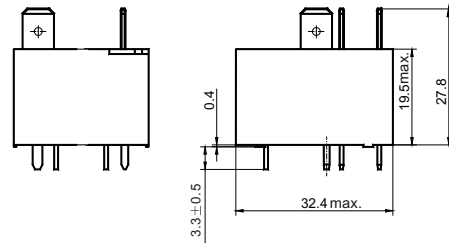

NT90T₂L

Dimensions

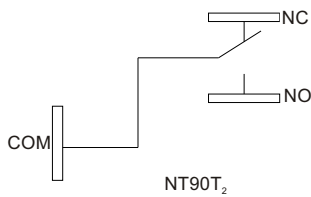

NT90T₂

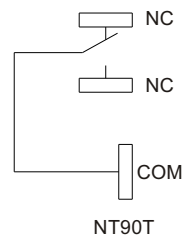

NT90T

Wiring diagram(Top view)

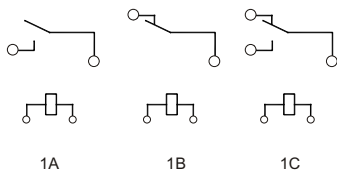

1A

1B

1C

Wiring diagram(Bottom view)

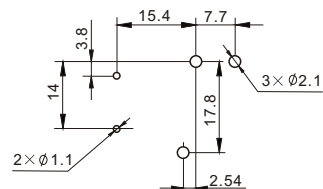

Mounting layout(Bottom view)

CAUTION: In case of no tolerance shown in outline dimension: outline dimension ≤ 1 mm, tolerance should be ± 0.2 mm; outline dimension > 1 mm and ≤ 5 mm, tolerance should be ± 0.3 mm; outline dimension > 5 mm, tolerance should be ± 0.4 mm.

Safety Approvals

Safety approval	UL&CUR	TüV
Load	NO:40A/240VAC; 30A/277VAC NC: 30A/240VAC,30VDC ;20A/277VAC Ballast:5A/280VAC TV-5 A:2HP 250VAC 1HP/16AFLA/120VAC 2HP/12AFLA/240VAC B:1 $\frac{1}{2}$ HP 250VAC 30LRA/10AFLA/120VAC 30LRA/10AFLA/240VAC	NO:40A/240VAC ,14VDC 30A/277VAC NC:30A/240VAC ,14VDC 20A/277VAC

Reference Data

