

SM 系列产品

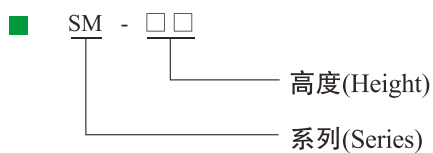

■ 工作温度: -40~+140

Operating Temperature: -40~+140

■ 嵌件: 黄铜、铁、铝

Insert: Brass, Steel with Zn coating

■ 材料: 不饱和聚酯树脂玻璃纤维增强模压塑料 (BMC) (SMC), 环保材料及UL认证材料

Material: BMC (Bough Moulding Compound)

SMC(Sheet Moulding Compound)

■ 颜色、嵌件、材料性能、螺纹可依客户需求定制

Colour, Insert, material In capability accordance screw with customer needs

SM BUS BAR INSULATOR(Drum)

■ SM-20 外观及尺寸(mm)

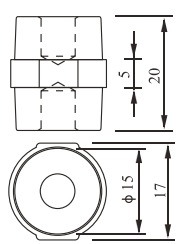

伸缩强度(LBS) Tensile strength(LBS)	300
耐压(KV) Voltage withstand(KV)	5
扭距(FT LBS) Torgue strength(FTLBS)	4
螺纹(mm) screw(mm)	5
螺纹深度(mm) screw depth(mm)	7

■ SM-45 外观及尺寸(mm)

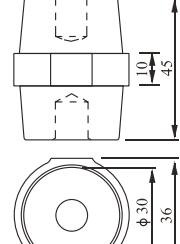

伸缩强度(LBS) Tensile strength(LBS)	1000
耐压(KV) Voltage withstand(KV)	14
扭距(FT LBS) Torgue strength(FTLBS)	20
螺纹(mm) screw(mm)	8
螺纹深度(mm) screw depth(mm)	11

■ SM-25 外观及尺寸(mm)

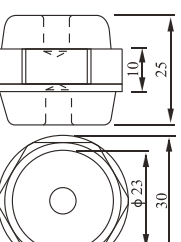

伸缩强度(LBS) Tensile strength(LBS)	500
耐压(KV) Voltage withstand(KV)	6
扭距(FT LBS) Torgue strength(FTLBS)	6
螺纹(mm) screw(mm)	6
螺纹深度(mm) screw depth(mm)	9

■ SM-51 外观及尺寸(mm)

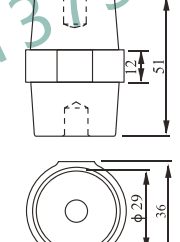

伸缩强度(LBS) Tensile strength(LBS)	1000
耐压(KV) Voltage withstand(KV)	15
扭距(FT LBS) Torgue strength(FTLBS)	20
螺纹(mm) screw(mm)	8
螺纹深度(mm) screw depth(mm)	14

■ SM-30 外观及尺寸(mm)

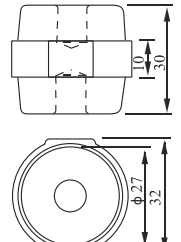

伸缩强度(LBS) Tensile strength(LBS)	550
耐压(KV) Voltage withstand(KV)	8
扭距(FT LBS) Torgue strength(FTLBS)	8
螺纹(mm) screw(mm)	8
螺纹深度(mm) screw depth(mm)	11

■ SM-60 外观及尺寸(mm)

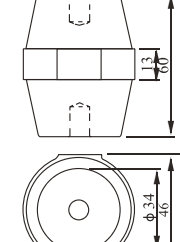

伸缩强度(LBS) Tensile strength(LBS)	1200
耐压(KV) Voltage withstand(KV)	20
扭距(FT LBS) Torgue strength(FTLBS)	35
螺纹(mm) screw(mm)	10
螺纹深度(mm) screw depth(mm)	15

■ SM-35 外观及尺寸(mm)

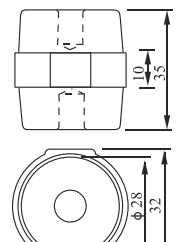

伸缩强度(LBS) Tensile strength(LBS)	600
耐压(KV) Voltage withstand(KV)	10
扭距(FT LBS) Torgue strength(FTLBS)	10
螺纹(mm) screw(mm)	8
螺纹深度(mm) screw depth(mm)	11

■ SM-76 外观及尺寸(mm)

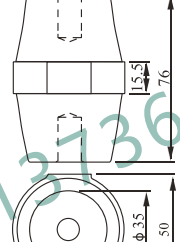

伸缩强度(LBS) Tensile strength(LBS)	1500
耐压(KV) Voltage withstand(KV)	25
扭距(FT LBS) Torgue strength(FTLBS)	40
螺纹(mm) screw(mm)	10
螺纹深度(mm) screw depth(mm)	20

■ SM-40 外观及尺寸(mm)

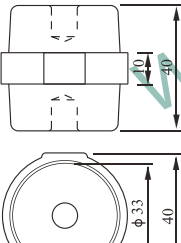

伸缩强度(LBS) Tensile strength(LBS)	650
耐压(KV) Voltage withstand(KV)	12
扭距(FT LBS) Torgue strength(FTLBS)	12
螺纹(mm) screw(mm)	8
螺纹深度(mm) screw depth(mm)	11

■ SM-80 外观及尺寸(mm)

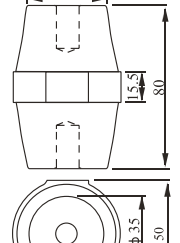

伸缩强度(LBS) Tensile strength(LBS)	
耐压(KV) Voltage withstand(KV)	
扭距(FT LBS) Torgue strength(FTLBS)	
螺纹(mm) screw(mm)	
螺纹深度(mm) screw depth(mm)	

TSM 系列产品

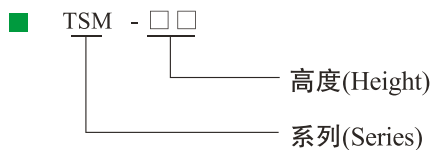

■ 工作温度: -40~+140

Operating Temperature: -40~+140

■ 嵌件: 黄铜、铁、铝

Insert: Brass, Steel with Zn coating

■ 材料: 不饱和聚酯树脂玻璃纤维增强模压塑料 (BMC) (SMC) 环保型DMC材料, 环保材料及UL认证材料

Material: BMC (Bough Moulding Compound)

SMC(Sheet Moulding Compound)

■ 颜色、嵌件、材料性能、螺纹可依客户需求定制

Colour, Insert, material In capability accordance screw with customer needs

■ 公制、美制、英制、螺纹可供客户选择

TSM BUS BAR INSULATOR

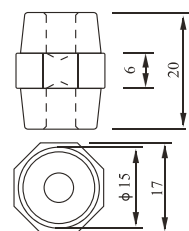

■ TSM-20 外观及尺寸(mm)

伸缩强度(LBS) Tensile strength(LBS)	300
耐压(KV) Voltage withstand(KV)	4
扭距(FT LBS) Torgue strength(FTLBS)	4
螺纹(mm) screw(mm)	5
螺纹深度(mm) screw depth(mm)	7

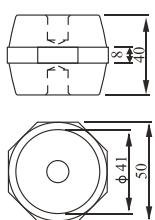

■ TSM-40 外观及尺寸(mm)

伸缩强度(LBS) Tensile strength(LBS)	1000
耐压(KV) Voltage withstand(KV)	8
扭距(FT LBS) Torgue strength(FTLBS)	30
螺纹(mm) screw(mm)	10
螺纹深度(mm) screw depth(mm)	14

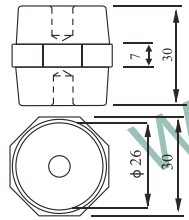

■ TSM-30 外观及尺寸(mm)

伸缩强度(LBS) Tensile strength(LBS)	500
耐压(KV) Voltage withstand(KV)	8
扭距(FT LBS) Torgue strength(FTLBS)	8
螺纹(mm) screw(mm)	6
螺纹深度(mm) screw depth(mm)	10

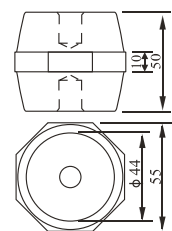

■ TSM-50 外观及尺寸(mm)

伸缩强度(LBS) Tensile strength(LBS)	1500
耐压(KV) Voltage withstand(KV)	15
扭距(FT LBS) Torgue strength(FTLBS)	40
螺纹(mm) screw(mm)	10
螺纹深度(mm) screw depth(mm)	17

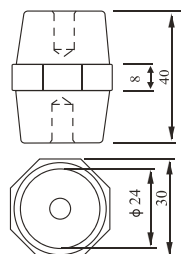

■ TSM-402 外观及尺寸(mm)

伸缩强度(LBS) Tensile strength(LBS)	500
耐压(KV) Voltage withstand(KV)	8
扭距(FT LBS) Torgue strength(FTLBS)	10
螺纹(mm) screw(mm)	6
螺纹深度(mm) screw depth(mm)	13

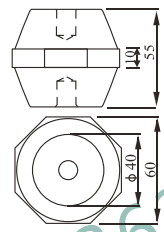

■ TSM-55 外观及尺寸(mm)

伸缩强度(LBS) Tensile strength(LBS)	2000
耐压(KV) Voltage withstand(KV)	15
扭距(FT LBS) Torgue strength(FTLBS)	50
螺纹(mm) screw(mm)	10
螺纹深度(mm) screw depth(mm)	17

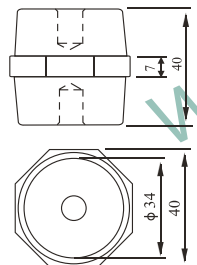

■ TSM-401 外观及尺寸(mm)

伸缩强度(LBS) Tensile strength(LBS)	700
耐压(KV) Voltage withstand(KV)	8
扭距(FT LBS) Torgue strength(FTLBS)	20
螺纹(mm) screw(mm)	8
螺纹深度(mm) screw depth(mm)	13

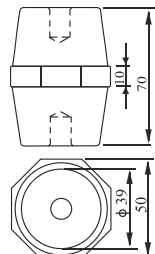

■ TSM-70 外观及尺寸(mm)

伸缩强度(LBS) Tensile strength(LBS)	1500
耐压(KV) Voltage withstand(KV)	25
扭距(FT LBS) Torgue strength(FTLBS)	40
螺纹(mm) screw(mm)	10
螺纹深度(mm) screw depth(mm)	17

SEP1615-3541 系列产品

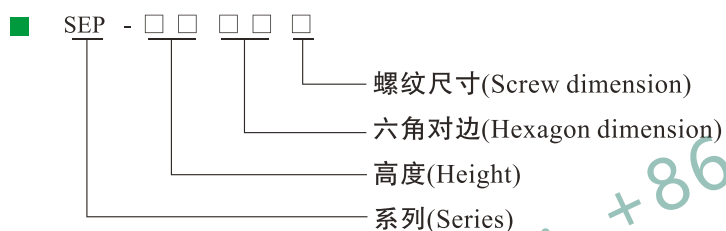

■ 工作温度: -40~+140

Operating Temperature: -40~+140

■ 嵌件: 黄铜、铁、铝

Insert: Brass, Steel with Zn coating

■ 材料: 不饱和聚酯树脂玻璃纤维增强模压塑料 (BMC) (SMC), 环保材料及UL认证材料

Material: BMC (Bough Moulding Compound)

SMC(Sheet Moulding Compound)

■ 颜色、嵌件、材料性能、螺紋可依客户需求定制

Colour, Insert, material In capability accordance screw with customer needs

SEP STANDOFF INSULATOR (Hexagonal)

SEP 1615 外观及尺寸(mm)

伸缩强度(LBS) Tensile strength(LBS)	300	
耐压(KV) Voltage withstand(KV)	4	
扭距(FT LBS) Torgue strength(FTLBS)	3	3
螺纹(mm) screw(mm)	4	5
螺纹深度(mm) screw depth(mm)	4	4

SEP 3030 外观及尺寸(mm)

伸缩强度(LBS) Tensile strength(LBS)	600	
耐压(KV) Voltage withstand(KV)	11	
扭距(FT LBS) Torgue strength(FTLBS)	10	20 20
螺纹(mm) screw(mm)	6	8 10
螺纹深度(mm) screw depth(mm)	9	9 9

SEP 2019 外观及尺寸(mm)

伸缩强度(LBS) Tensile strength(LBS)	400	
耐压(KV) Voltage withstand(KV)	7	
扭距(FT LBS) Torgue strength(FTLBS)	3	6 10
螺纹(mm) screw(mm)	4	5 6
螺纹深度(mm) screw depth(mm)	6	6 6

SEP 3040 外观及尺寸(mm)

伸缩强度(LBS) Tensile strength(LBS)	700	
耐压(KV) Voltage withstand(KV)	11	
扭距(FT LBS) Torgue strength(FTLBS)	30	40
螺纹(mm) screw(mm)	8	10
螺纹深度(mm) screw depth(mm)	9	9

SEP 2519 外观及尺寸(mm)

伸缩强度(LBS) Tensile strength(LBS)	400	
耐压(KV) Voltage withstand(KV)	8.5	
扭距(FT LBS) Torgue strength(FTLBS)	6	8
螺纹(mm) screw(mm)	5	6
螺纹深度(mm) screw depth(mm)	6	6

SEP 3532 外观及尺寸(mm)

伸缩强度(LBS) Tensile strength(LBS)	650	
耐压(KV) Voltage withstand(KV)	12.5	
扭距(FT LBS) Torgue strength(FTLBS)	10	25 40
螺纹(mm) screw(mm)	6	8 10
螺纹深度(mm) screw depth(mm)	9	10 10

SEP 2522 外观及尺寸(mm)

伸缩强度(LBS) Tensile strength(LBS)	500	
耐压(KV) Voltage withstand(KV)	8.5	
扭距(FT LBS) Torgue strength(FTLBS)	3	6 10
螺纹(mm) screw(mm)	4	5 6
螺纹深度(mm) screw depth(mm)	7	7 7

SEP 3540 外观及尺寸(mm)

伸缩强度(LBS) Tensile strength(LBS)	700	
耐压(KV) Voltage withstand(KV)	12.5	
扭距(FT LBS) Torgue strength(FTLBS)	25	50
螺纹(mm) screw(mm)	8	10
螺纹深度(mm) screw depth(mm)	10	10

SEP 2525 外观及尺寸(mm)

伸缩强度(LBS) Tensile strength(LBS)	550	
耐压(KV) Voltage withstand(KV)	8.5	
扭距(FT LBS) Torgue strength(FTLBS)	10	
螺纹(mm) screw(mm)	8	
螺纹深度(mm) screw depth(mm)	9	

SEP 3541 外观及尺寸(mm)

伸缩强度(LBS) Tensile strength(LBS)	700	
耐压(KV) Voltage withstand(KV)	12.5	
扭距(FT LBS) Torgue strength(FTLBS)	10	25 50
螺纹(mm) screw(mm)	6	8 10
螺纹深度(mm) screw depth(mm)	9	10 10

SEP4041-7550 系列产品

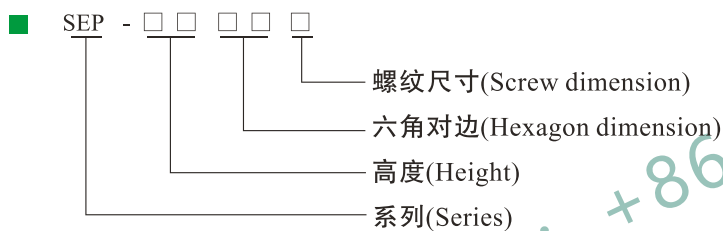

■ 工作温度: -40~+140

Operating Temperature: -40~+140

■ 嵌件: 黄铜、铁、铝

Insert: Brass, Steel with Zn coating

■ 材料: 不饱和聚酯树脂玻璃纤维增强模压塑料 (BMC) (SMC), 环保材料及UL认证材料

Material: BMC (Bough Moulding Compound)

SMC(Sheet Moulding Compound)

■ 颜色、嵌件、材料性能、螺紋可依客户需求定制

Colour, Insert, material In capability accordance screw with customer needs

SEP STANDOFF INSULATOR (Hexagonal)

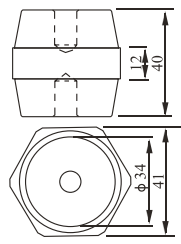

SEP 4041 外观及尺寸(mm)

伸缩强度(LBS) Tensile strength(LBS)	800	
耐压(KV) Voltage withstand(KV)	14	
扭距(FT LBS) Torgue strength(FTLBS)	25	50 85
螺纹(mm) screw(mm)	8	10 12
螺纹深度(mm) screw depth(mm)	10	10 10

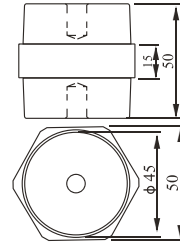

SEP 5050 外观及尺寸(mm)

伸缩强度(LBS) Tensile strength(LBS)	1500	
耐压(KV) Voltage withstand(KV)	15.5	
扭距(FT LBS) Torgue strength(FTLBS)	25	50 85
螺纹(mm) screw(mm)	8	10 12
螺纹深度(mm) screw depth(mm)	15	15 15

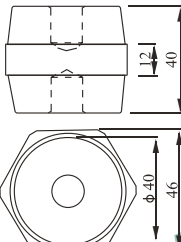

SEP 4046 外观及尺寸(mm)

伸缩强度(LBS) Tensile strength(LBS)	1000	
耐压(KV) Voltage withstand(KV)	14	
扭距(FT LBS) Torgue strength(FTLBS)	25	50 85
螺纹(mm) screw(mm)	8	10 12
螺纹深度(mm) screw depth(mm)	10	10 12

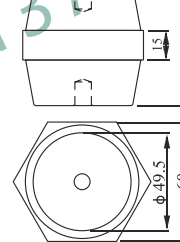

SEP 6060 外观及尺寸(mm)

伸缩强度(LBS) Tensile strength(LBS)	2000	
耐压(KV) Voltage withstand(KV)	21	
扭距(FT LBS) Torgue strength(FTLBS)	25	50 85
螺纹(mm) screw(mm)	8	10 12
螺纹深度(mm) screw depth(mm)	15	15 20

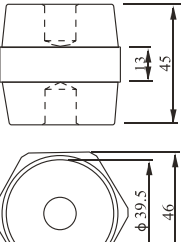

SEP 4546 外观及尺寸(mm)

伸缩强度(LBS) Tensile strength(LBS)	1000	
耐压(KV) Voltage withstand(KV)	15.5	
扭距(FT LBS) Torgue strength(FTLBS)	25	50 85
螺纹(mm) screw(mm)	8	10 12
螺纹深度(mm) screw depth(mm)	15	15 15

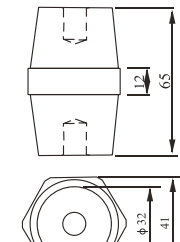

SEP 6541 外观及尺寸(mm)

伸缩强度(LBS) Tensile strength(LBS)	1000	
耐压(KV) Voltage withstand(KV)	22	
扭距(FT LBS) Torgue strength(FTLBS)	25	50 85
螺纹(mm) screw(mm)	8	10 12
螺纹深度(mm) screw depth(mm)	15	20 20

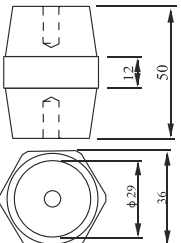

SEP 5036 外观及尺寸(mm)

伸缩强度(LBS) Tensile strength(LBS)	900	
耐压(KV) Voltage withstand(KV)	15.5	
扭距(FT LBS) Torgue strength(FTLBS)	10	25 50
螺纹(mm) screw(mm)	6	8 10
螺纹深度(mm) screw depth(mm)	15	15 15

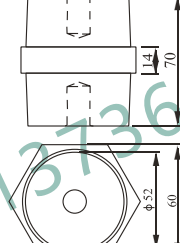

SEP 7060 外观及尺寸(mm)

伸缩强度(LBS) Tensile strength(LBS)	2000	
耐压(KV) Voltage withstand(KV)	25	
扭距(FT LBS) Torgue strength(FTLBS)	50	85 200
螺纹(mm) screw(mm)	10	12 16
螺纹深度(mm) screw depth(mm)	20	20 25

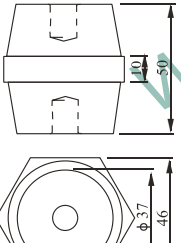

SEP 5046 外观及尺寸(mm)

伸缩强度(LBS) Tensile strength(LBS)	1100	
耐压(KV) Voltage withstand(KV)	15.5	
扭距(FT LBS) Torgue strength(FTLBS)	50	
螺纹(mm) screw(mm)	10	
螺纹深度(mm) screw depth(mm)	15	

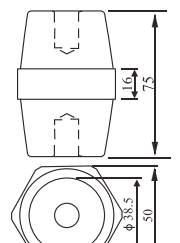

SEP 7550 外观及尺寸(mm)

伸缩强度(LBS) Tensile strength(LBS)	1500	
耐压(KV) Voltage withstand(KV)	28	
扭距(FT LBS) Torgue strength(FTLBS)	25	50 85
螺纹(mm) screw(mm)	8	10 12
螺纹深度(mm) screw depth(mm)	15	15 20

SB 系列产品 *Round Hex*



TYPE	A/F (mm)	VALUES											TORQUE STRENGTH (FTLBS)	SCREW (mm)						
		H (mm)																		
SB14	14	14	16	18	20	25	30	35	40	45	50	60				3	5	6		
SB16	16	16	18	20	25	30	35	40	45	50	55	60				4	5	6		
SB20	20	16	18	20	25	30	35	40	45	50	55	60	65	70	78.8	80	90	5	5	6
SB30	30	30	35	40	50	60					65				10	6	8			
SB35	35	45											35	10						
SB40	40	30	35	40	50	60					70				16	8	10			
SB60	60	40	50	60	70					80				50	12	16				

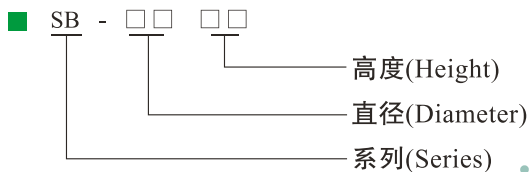

■ 工作温度: -40~+140

Operating Temperature: -40~+140

■ 嵌件: 黄铜、铁、铝

Insert: Brass, Steel with Zn coating

■ 材料: 不饱和聚酯树脂玻璃纤维增强模压塑料 (BMC) (SMC), 环保材料及UL认证材料

Material: BMC (Bough Moulding Compound)

SMC (Sheet Moulding Compound)

■ 颜色、嵌件、材料性能可依客户需求定制

Colour, Insert, material In capability accordance screw with customer needs

Conical



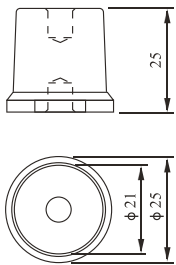

■ C□25 外观及尺寸(mm)

伸缩强度(LBS) Tensile strength(LBS)	500
耐压(KV) Voltage withstand(KV)	6
扭距(FT LBS) Torgue strength(FTLBS)	6
螺纹(mm) screw(mm)	6
螺纹深度(mm) screw depth(mm)	9

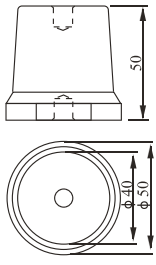

■ C□50 外观及尺寸(mm)

伸缩强度(LBS) Tensile strength(LBS)	1000
耐压(KV) Voltage withstand(KV)	15
扭距(FT LBS) Torgue strength(FTLBS)	12 20
螺纹(mm) screw(mm)	8 10
螺纹深度(mm) screw depth(mm)	12 15

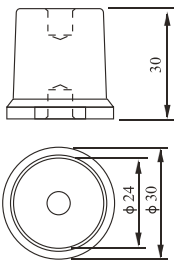

■ C□30 外观及尺寸(mm)

伸缩强度(LBS) Tensile strength(LBS)	500
耐压(KV) Voltage withstand(KV)	8
扭距(FT LBS) Torgue strength(FTLBS)	6 8
螺纹(mm) screw(mm)	6 8
螺纹深度(mm) screw depth(mm)	9 12

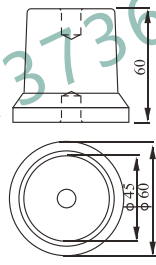

■ C□60 外观及尺寸(mm)

伸缩强度(LBS) Tensile strength(LBS)	1200
耐压(KV) Voltage withstand(KV)	20
扭距(FT LBS) Torgue strength(FTLBS)	20 40
螺纹(mm) screw(mm)	10 12
螺纹深度(mm) screw depth(mm)	15 18

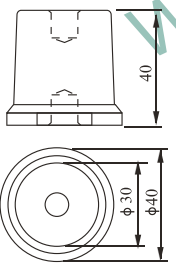

■ C□40 外观及尺寸(mm)

伸缩强度(LBS) Tensile strength(LBS)	650
耐压(KV) Voltage withstand(KV)	12
扭距(FT LBS) Torgue strength(FTLBS)	12
螺纹(mm) screw(mm)	6 8
螺纹深度(mm) screw depth(mm)	12

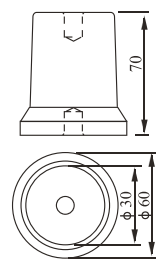

■ C□70 外观及尺寸(mm)

伸缩强度(LBS) Tensile strength(LBS)	1500
耐压(KV) Voltage withstand(KV)	22
扭距(FT LBS) Torgue strength(FTLBS)	20 40
螺纹(mm) screw(mm)	10 12
螺纹深度(mm) screw depth(mm)	15 18

EN 系列产品

Full Hex



Whatsapp: +8613736382016

TYPE	A/F (mm)	VALUES						
		H (mm)	TORGUE STRENGTH (FTLBS)	SCREW (mm)	SCREW DEPTH (mm)			
EN25	26	25	10	6	9			
EN30	26	30	10	6	9			
EN32	26	32	10	6	9			
EN40	26	40	10	6	9			
EN100	45	100	25	40	10	12	15	18
EN110	45	110	25	40	10	12	15	18
EN120	45	120	25	40	10	12	15	18

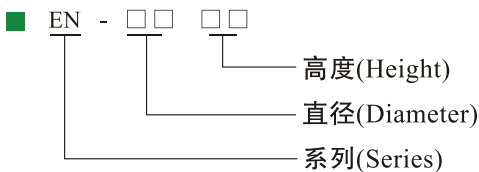

- 工作温度: -40~+140
Operating Temperature: -40~+140
- 嵌件: 黄铜、铁、铝
Insert: Brass, Steel with Zn coating
- 材料: 不饱和聚酯树脂玻璃纤维增强模压塑料(BMC)(SMC), 环保材料及UL认证材料
Material: BMC (Bough Moulding Compound)
SMC(Sheet Moulding Compound)
- 颜色、嵌件、材料性能可依客户需求定制
Colour, Insert, material In capability accordance with customer needs

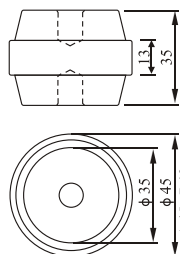

■ U4535 外观及尺寸(mm)	
伸缩强度(LBS) Tensile strength(LBS)	700
耐压(KV) Voltage withstand(KV)	6
扭矩(FT LBS) Torgue strength(FTLBS)	12
螺纹(mm) screw(mm)	10 UNC3/8-16
螺纹深度(mm) screw depth(mm)	12

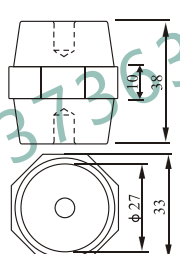

■ 7105 外观及尺寸(mm)	
伸缩强度(LBS) Tensile strength(LBS)	650
耐压(KV) Voltage withstand(KV)	8
扭矩(FT LBS) Torgue strength(FTLBS)	8
螺纹(mm) screw(mm)	6
螺纹深度(mm) screw depth(mm)	10

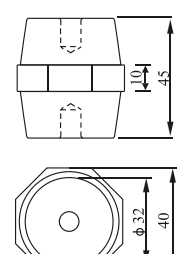

■ 7110 外观及尺寸(mm)	
伸缩强度(LBS) Tensile strength(LBS)	800
耐压(KV) Voltage withstand(KV)	10
扭矩(FT LBS) Torgue strength(FTLBS)	10
螺纹(mm) screw(mm)	8
螺纹深度(mm) screw depth(mm)	12

Cylindrical



■ $\Phi 30 \times 30$ 外观及尺寸(mm)

伸缩强度(LBS) Tensile strength(LBS)	500
耐压(KV) Voltage withstand(KV)	5
扭距(FT LBS) Torgue strength(FTLBS)	8
螺纹(mm) screw(mm)	6
螺纹深度(mm) screw depth(mm)	10

■ $\Phi 40 \times 60$ 外观及尺寸(mm)

伸缩强度(LBS) Tensile strength(LBS)	650
耐压(KV) Voltage withstand(KV)	15
扭距(FT LBS) Torgue strength(FTLBS)	40
螺纹(mm) screw(mm)	10
螺纹深度(mm) screw depth(mm)	15

■ $\Phi 30 \times 40$ 外观及尺寸(mm)

伸缩强度(LBS) Tensile strength(LBS)	500
耐压(KV) Voltage withstand(KV)	6
扭距(FT LBS) Torgue strength(FTLBS)	10
螺纹(mm) screw(mm)	6
螺纹深度(mm) screw depth(mm)	12

■ $\Phi 50 \times 40$ 外观及尺寸(mm)

伸缩强度(LBS) Tensile strength(LBS)	1000
耐压(KV) Voltage withstand(KV)	10
扭距(FT LBS) Torgue strength(FTLBS)	50
螺纹(mm) screw(mm)	10
螺纹深度(mm) screw depth(mm)	13

■ $\Phi 40 \times 40$ 外观及尺寸(mm)

伸缩强度(LBS) Tensile strength(LBS)	650
耐压(KV) Voltage withstand(KV)	10
扭距(FT LBS) Torgue strength(FTLBS)	12
螺纹(mm) screw(mm)	8
螺纹深度(mm) screw depth(mm)	13

MNS 系列产品 *Cylindrical*

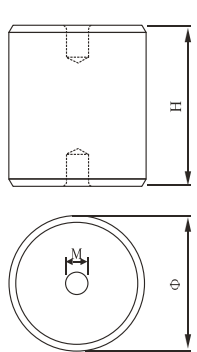

	TYPE	Diameter (mm)	VALUES							
			H (mm)					SCREW (mm)		SCREW DEPTH (mm)
MNS16×□□	Φ 16	20	25	30	35	40	M6		8	
MNS20×□□	Φ 20	20	25	30	35	40	M6		8	
MNS25×□□	Φ 25	25	30	40	50		M6		9	
MNS30×□□	Φ 30	30	40	50	60		M8		9	
MNS40×□□	Φ 40	40	50	60	70	80	M8	M10	12	
MNS50×□□	Φ 50	50	60	70	80	40	M8	M10	15	
MNS60×□□	Φ 60	60	70	60	70	80	M10	M12	15	
MNS70×□□	Φ 70	70	80	90	100	110	M14	M16	18	22

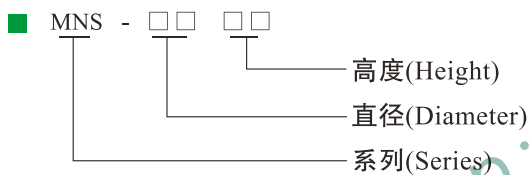

■ 工作温度: -40~+140

Operating Temperature: -40~+140

■ 嵌件: 黄铜、铁、铝

Insert: Brass, Steel with Zn coating

■ 材料: 不饱和聚酯树脂玻璃纤维增强模压塑料 (BMC) (SMC), 环保材料及UL认证材料

Material: BMC (Bough Moulding Compound)

SMC(Sheet Moulding Compound)

■ 颜色、嵌件、材料性能、螺纹可依客户需求定制

Colour, Insert, material In capability accordance screw with customer needs

D系列产品



Whatsapp: +8613736382016

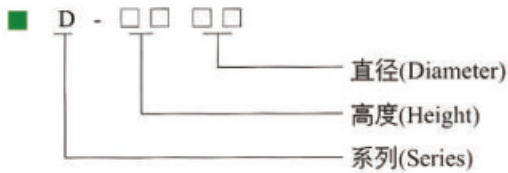

■ **D2525** 外观及尺寸(mm)

伸缩强度(LBS) Tensile strength(LBS)	500
耐压(KV) Voltage withstand(KV)	5
扭矩(FT LBS) Torgue strength(FT LBS)	20
螺纹(mm) screw(mm)	8
螺纹深度(mm) screw depth(mm)	9

■ **D3030** 外观及尺寸(mm)

伸缩强度(LBS) Tensile strength(LBS)	700
耐压(KV) Voltage withstand(KV)	6
扭矩(FT LBS) Torgue strength(FT LBS)	30
螺纹(mm) screw(mm)	8
螺纹深度(mm) screw depth(mm)	10

■ **D5040** 外观及尺寸(mm)

伸缩强度(LBS) Tensile strength(LBS)	1000
耐压(KV) Voltage withstand(KV)	10
扭矩(FT LBS) Torgue strength(FT LBS)	50
螺纹(mm) screw(mm)	10
螺纹深度(mm) screw depth(mm)	15

■ **D4040** 外观及尺寸(mm)

伸缩强度(LBS) Tensile strength(LBS)	800
耐压(KV) Voltage withstand(KV)	10
扭矩(FT LBS) Torgue strength(FT LBS)	35
螺纹(mm) screw(mm)	10
螺纹深度(mm) screw depth(mm)	15

■ **D6040** 外观及尺寸(mm)

伸缩强度(LBS) Tensile strength(LBS)	2000
耐压(KV) Voltage withstand(KV)	12
扭矩(FT LBS) Torgue strength(FT LBS)	50
螺纹(mm) screw(mm)	10
螺纹深度(mm) screw depth(mm)	18

CT 系列产品

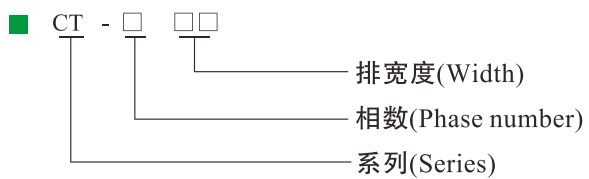

■ 工作温度: -40~+140

Operating Temperature: -40 ~ +140

■ 嵌件: 黄铜、铁、铝

Insert: Brass, Steel with Zn coating

■ 材料: 不饱和聚酯树脂玻璃纤维增强模压塑料 (BMC) (SMC), 环保材料及UL认证材料

Material: BMC (Bough Moulding Compound)

SMC(Sheet Moulding Compound)

■ 颜色、嵌件、材料性能可依客户需求定制

Colour, Insert, material In capability accordance screw with customer needs

■ CT4-20

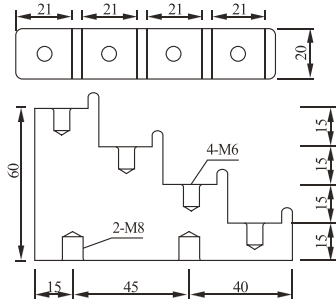

■ CT2-25

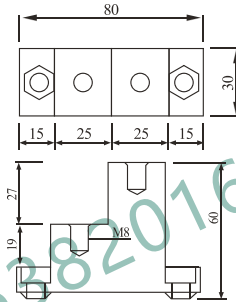

■ CT4-30

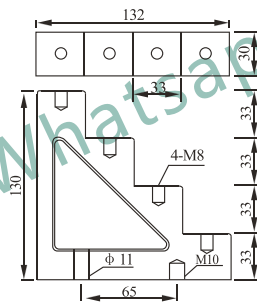

■ CT5-25

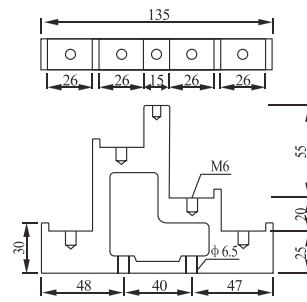

■ CT4-40

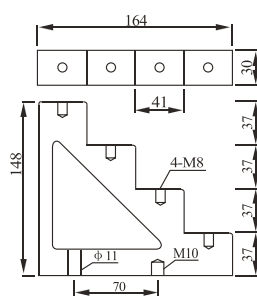

■ J4-30

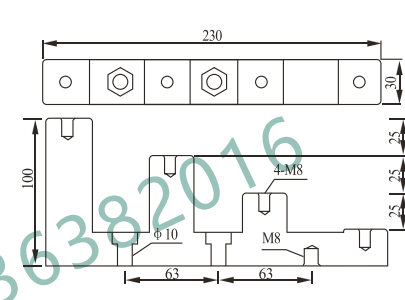

■ CT4-50

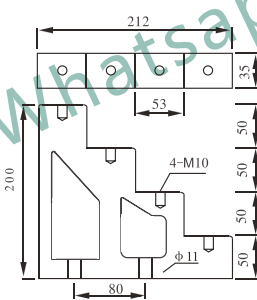

■ J4-40

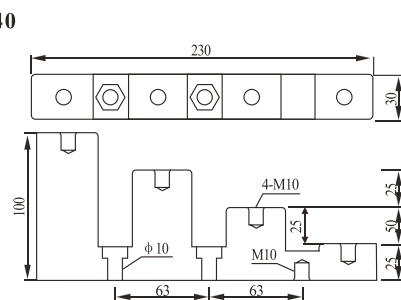

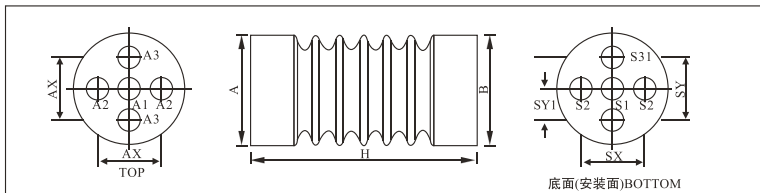
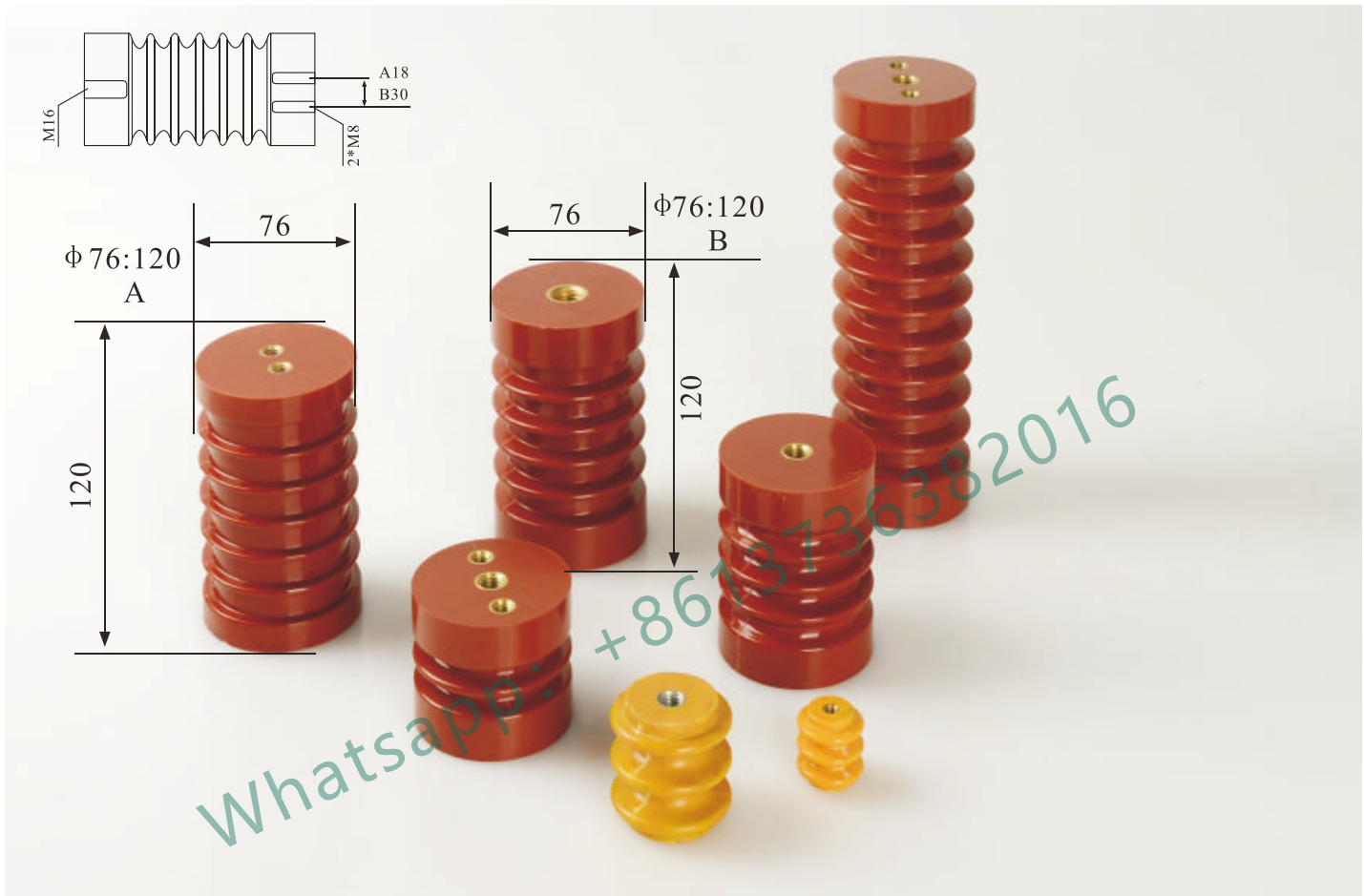

1. Material: Bulk molding compound, unsaturated polyester
2. Nut inserts: Brass, various specifications are available.
3. Test specifications: JIS C3801 and JIS C3851
4. Color: Dark brown or dark red.
5. Dimension and characteristics

Part No.	76:120	EL-24	EL-15	EL-12	EL-6M	EL-3M	
End diameters (A/B).mm	76	70	70	58	70	70	
Height(H).mm	120	210	142	130	90	60	
Surface leakage distance, mm	300	356	210	172	125	88	
Rated voltage.kV	10	24	15	12	7.2	3.6	
Low frequency dielectric strenght .kV	55	60	50	36	22	16	
Impule voltage resistance, kV	110	125	110	95	75	60	
Persistent begding strength. I min, kg	400	300	400	300	400	400	
Tensile strength, kg	>1500	>1500	>1500	>2000	>1200	>1200	
Torque stength.kg-m	>25	>25	>25	>25	>25	>25	
Inseris arrangement	Top	A1	M16	M10/M12	M8/M10	M10	M10
		A2	-/M8	-	-	M8	M8
		A3	-	M6/M8	M6/M8	-	-
		AX	-	-	-	36	40
		AY	-	36/40	36/40	-	-
		SY	-	M10/M12/M16	M10/M12/M16	M10/M16	M10
	BOTTOM	S2	-	-	-	-	-
		S3	-	-	-	-	-
		S31	-	-	-	-	-
		SX	-	-	-	-	-
		SY	-	-	-	-	-
		SYI	-	-	-	-	-

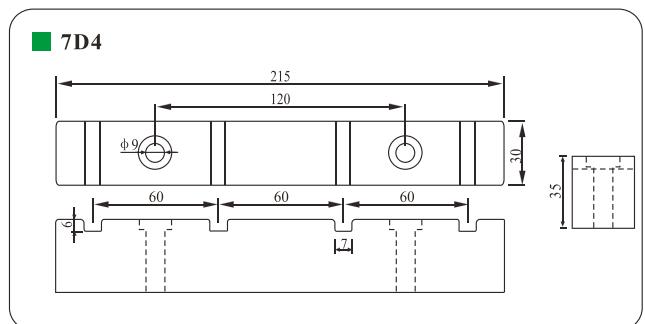
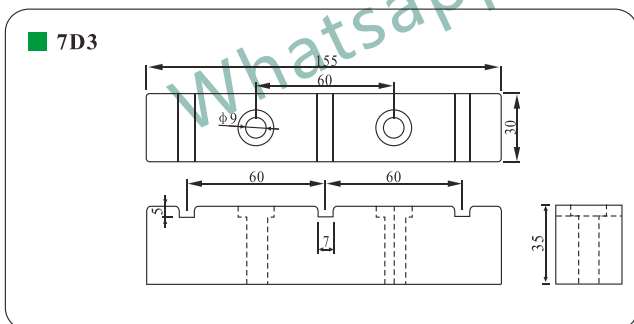
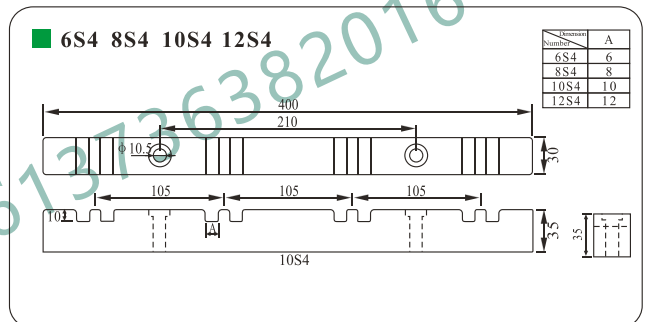
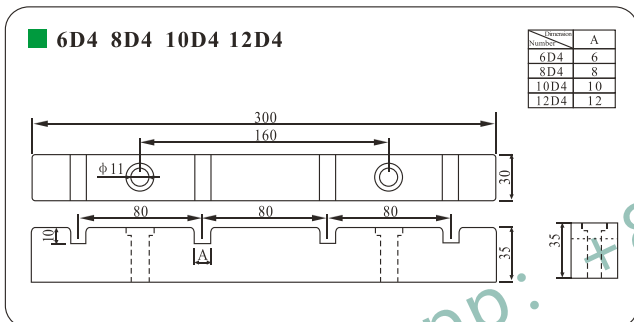
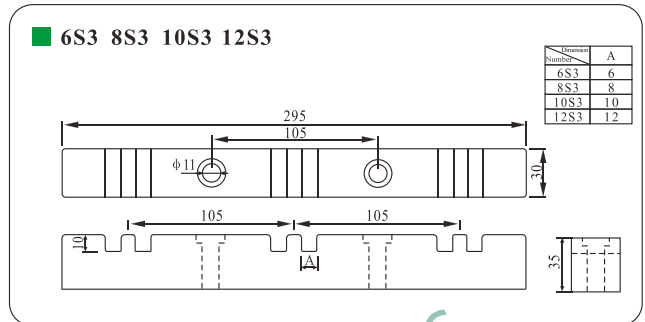
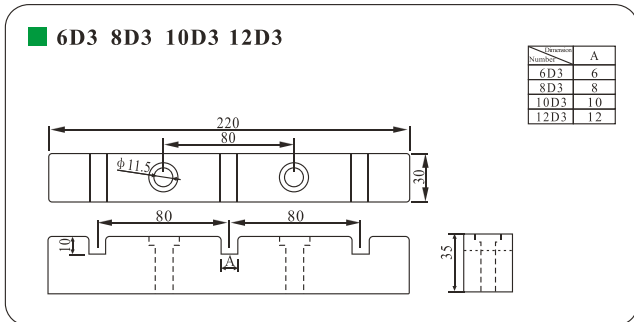
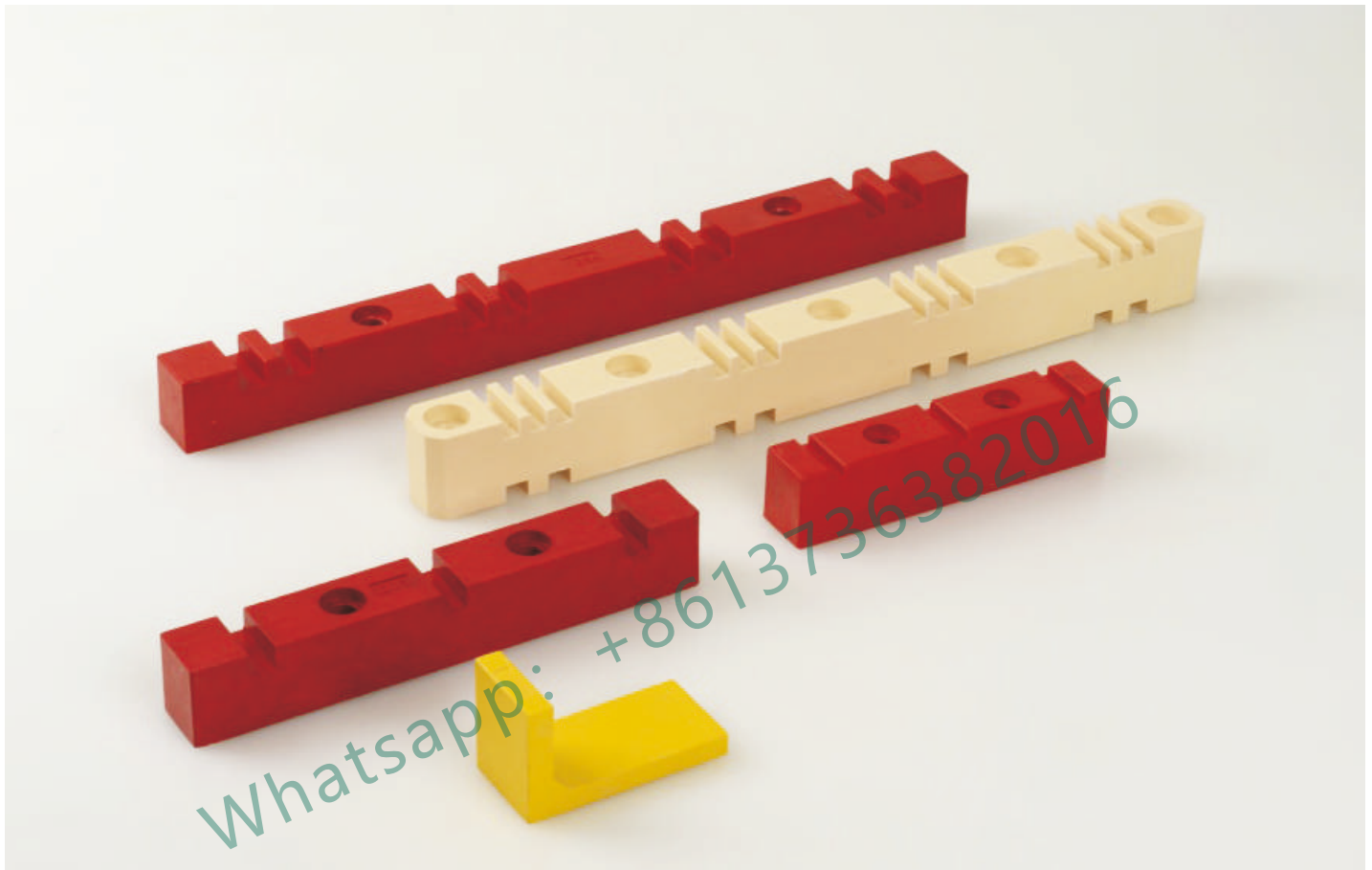

PMJ、MD系列绝缘母线框

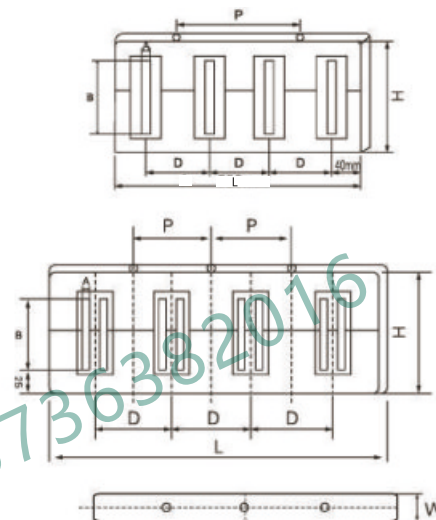

采用DMC型不饱和树脂，产品规格可用内钳块调节，使用方便。

产品名称	产品型号	长度(L)	厚度(W)	相数	相距(D)	孔距(P)	规格(AxB)	高(H)
GCK母线框	PMJ	310mm	40mm	四相	80mm	160mm	4×40	90mm
GCK母线框	MD2	290mm	40mm	三相	110mm	110mm	5×50	110mm
GCK母线框	MD3	240mm	40mm	三相	80mm	80mm	6×60	110mm
GCK母线框	MD4	420mm	40mm	四相	110mm	110mm×2	8×80	130mm
GCK母线框	MD5	310mm	40mm	四相	110mm	110mm×2	10×80	130mm
GCK母线框	MD6	390mm	40mm	三相	120mm	160mm	8×100	150mm
GCK母线框	MD7	460mm	40mm	四相	100mm	100mm×2	10×100	150mm
GCK母线框	MD8	390mm	40mm	四相	100mm	100mm×2	10×120	170mm
GCK母线框	MD7	460mm	40mm	四相	120mm	120mm×2	12×120	170mm
GCK母线框	MD8	290mm	40mm	三相	100mm	100mm	10×125	175mm
GCK母线框	MD8	290mm	40mm	三相	100mm	100mm	12×125	175mm

绝缘母线夹

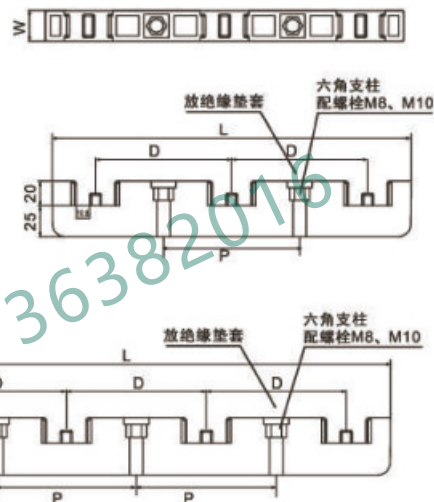

采用DMC型不饱和树脂，产品规格可用内钳块调节，使用方便。

产品名称	产品型号	长度(L)	厚度(W)	相数	相距(D)	孔距(P)	规格	高(H)
绝缘母线夹	D0-240L	240mm	25mm	三相	80	160mm	4×40	90mm
绝缘母线夹	D0-280L	280mm	25mm	三相	100	110mm	5×50	110mm
绝缘母线夹	D0-280L	280mm	25mm	三相	110	80mm	6×60	110mm
绝缘母线夹	D0-320	320mm	25mm	三相	120	110mm×2	8×80	130mm
绝缘母线夹	D0-320L	320mm	25mm	四相	80	160mm	10×80	130mm
绝缘母线夹	D0-380L	380mm	25mm	四相	100	100mm×2	10×100	150mm
绝缘母线夹	D0-380L	380mm	25mm	四相	100	100mm×2	10×120	170mm
绝缘母线夹	D0-380L	380mm	25mm	四相	130	120mm×2	12×120	170mm
绝缘母线夹	D0-380L	380mm	25mm	四相	130	120mm×2	10×125	175mm
绝缘母线夹	D0-380L	380mm	25mm	四相	130	120mm×2	12×125	175mm



型号及含义



产品性能

工作温度: -40°C~+140°C;

材料: 不饱和聚酯树脂玻璃纤维增强压塑料(BMC)(SMC);

颜色、材料性能可依客户需求定制。

注: 加热缩宽度加 2mm

PMJ9-3 三相间距 120mm 分单母排、双母排、三母排

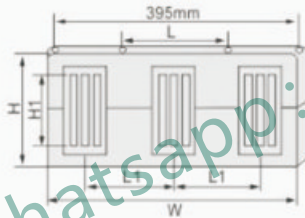

W (mm)	H (mm)	母线 × H1 (mm)	双母线 × H1 (mm)	L (mm)	L1 (mm)
390	128	10×80	10×80	120	120
390	148	10×100	10×100	120	120
390	168	12×120	10×120	120	120
390	172	14×125	12×125	120	120

H1 可选择: 40、60、80、100、120、125mm
 单母线厚度可选择: 10、12、14mm
 双母线厚度可选择: 10、12、14mm

PMJ9-4 三相间距 150mm 分单母排、双母排、三母排

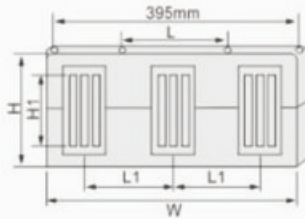

W (mm)	H (mm)	母线 × H1 (mm)	双母线 × H1 (mm)	L (mm)	L1 (mm)
420	130	10×80	10×80	150	150
420	150	10×100	10×100	150	150
420	170	12×120	10×120	150	150
420	175	14×125	12×125	150	150

H1 可选择: 40、60、80、100、120、125mm
 单母线厚度可选择: 10、12、14mm
 双母线厚度可选择: 10、12、14mm

PMJ9-5 三相间距 170mm 分单母排、双母排、三母排

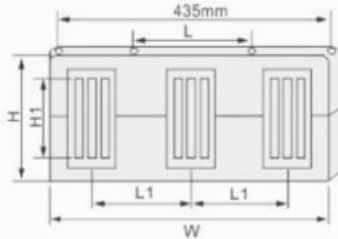

W (mm)	H (mm)	母线 × H1 (mm)	双母线 × H1 (mm)	L (mm)	L1 (mm)
460	130	10×80	10×80	120	120
460	150	10×100	10×100	120	120
460	170	12×120	10×120	120	120
460	175	14×125	12×125	120	120

H1 可选择: 40、60、80、100、120、125mm
 单母线厚度可选择: 10、12、14mm
 双母线厚度可选择: 10、12、14mm

PMJ9-6 四相间距 120mm 分单母排、双母排、三母排

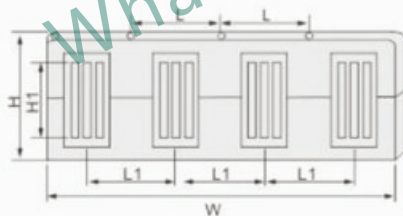

W (mm)	H (mm)	母线 × H1 (mm)	双母线 × H1 (mm)	L (mm)	L1 (mm)
460	130	10×80	10×80	120	120
460	150	10×100	10×100	120	120
460	170	12×120	10×120	120	120
460	175	14×125	12×125	120	120

H1 可选择: 40、60、80、100、120、125mm
 单母线厚度可选择: 10、12、14mm
 双母线厚度可选择: 10、12、14mm

ZMJ1组合式母线夹

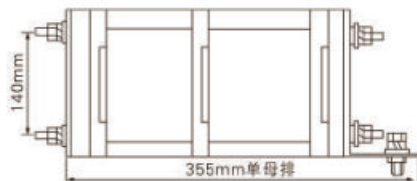

适用于GGD低压配电柜做为主母线固定之用

ZMJ1单母排		
3×30	4×40	5×50
6×60	6×80	6×100
8×80	8×100	10×50
10×60	10×80	10×100
10×120	10×125	12×120

备注：ZMJ2长415mm、ZMJ3长475mm

LMJ1零母线夹

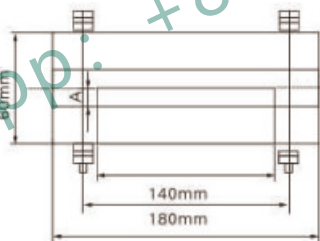
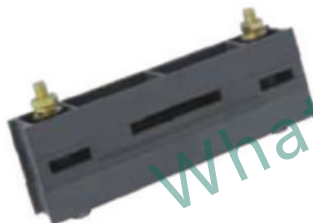

适用于GGD低压配电柜做为主母线固定之用

LMJ零母线夹		
3×30	4×40	5×50
6×60	6×80	6×100
8×80	8×100	10×50
10×60	10×80	10×100
10×120	10×125	12×120

备注：LMJ2高80mm

JK屏用母线框

采用DMC不饱和树脂制成绝缘性能优良、强度高、额定电压为660V配电柜的主母线。

AMJ2单母线框（材料DMC树脂、塑料）

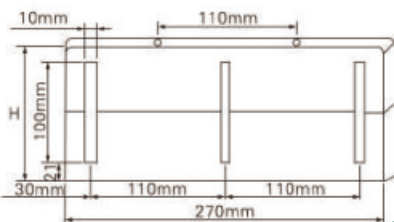

AMJ2单母线框	H	AMJ2单母线框	H
4×40	86	8×60	106
5×50	96	10×60	106
6×60	106	10×80	126
8×80	126	10×120	166
10×100	146	12×120	166

AMJ2型双母线框（材料DMC树脂、PC塑料）

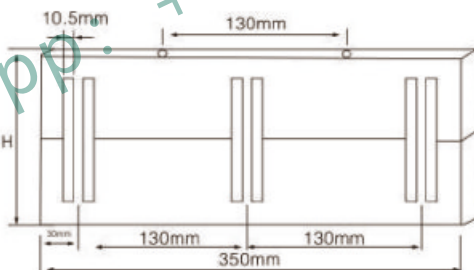
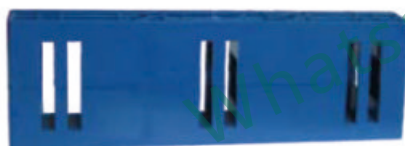

AMJ2双母线框	H	AMJ2双母线框	H
6×60	106	8×80	126
10×60	106	10×80	126
8×100	146	10×100	146
10×120	166	12×120	166