

COMPANY PROFILE

KINGREAL MACHINERY

BOTH **COIL SLITTING MACHINE AND CUT TO LENGTH LINE** ESSENTIALLY FUNCTION TO PROCESS METAL COILS AND HAVE A WIDE RANGE OF APPLICATIONS IN ALL MAJOR INDUSTRIES. **GUANGZHOU KINGREAL MACHINERY CO., LTD** IS A SPECIALIZED MANUFACTURER OF COIL SLITTING MACHINES AND CTL LINES AND IS COMMITTED TO BRINGING HIGH QUALITY MACHINES AND EQUIPMENT TO OUR CUSTOMERS.

FOR MORE THAN **20 YEARS**, **GUANGZHOU KINGREAL MACHINERY CO., LTD** HAS BEEN FOCUSING ON OPTIMIZING AND INNOVATING DIFFERENT PROCESSES TO ENSURE THAT ITS MACHINE PRODUCTS BRING PROJECT SUCCESS TO ITS CUSTOMERS IN TERMS OF PRODUCTION QUALITY, PRODUCTIVITY AND LONGEVITY.

"PROFESSIONAL TECHNICAL LEVEL AND PERFECT AFTER-SALES SERVICE" IS THE PRINCIPLE THAT **GUANGZHOU KINGREAL MACHINERY CO., LTD** HAS BEEN ADHERING TO FOR MANY YEARS, TO BE RESPONSIBLE FOR EVERY CUSTOMER, TO DO A GOOD JOB OF INSTALLATION AND AFTER-SALES SERVICE FOR EVERY PROJECT, IN ORDER TO MAKE US GET THE RECOGNITION OF CUSTOMERS FROM ALL OVER THE WORLD. SO FAR, **KINGREAL** HAS REACHED A LONG-TERM AND STABLE COOPERATION WITH **INDONESIA, SAUDI ARABIA, THE UNITED ARAB EMIRATES, TURKEY AND RUSSIA AND OTHER COUNTRIES AND REGIONS.**

NEW INNOVATIONS AND DEVELOPMENTS CONTINUE IN 2024, WELCOME TO **GUANGZHOU KINGREAL MACHINERY CO., LTD**. 不管是**金属纵剪线**还是**金属横剪线**本质的功能都是为了加工金属卷材，在各大行业有着广泛的应用。**GUANGZHOU KINGREAL MACHINERY CO., LTD**是专业制造分条机和剪板线的供应商，致力于为客户带来高质量的机器设备。20多年来，**GUANGZHOU KINGREAL MACHINERY CO., LTD**专注于不同加工工艺的优化和创新，以确保机器产品在生产质量、生产效益和使用寿命等多个方面为客户带来项目上的成功。

"专业的技术水平和完善的售后服务"是**GUANGZHOU KINGREAL MACHINERY CO., LTD**多年来一直坚持的原则，对每一个客户认真负责，对每一个项目做好售后的安装和为止，才能使得我们获得来自世界客户客户的认可。目前为止，**KINGREAL**已经与**印度尼西亚、沙特、阿联酋、土耳其和俄罗斯**等多个国家和地区达成长期稳定的合作关系。

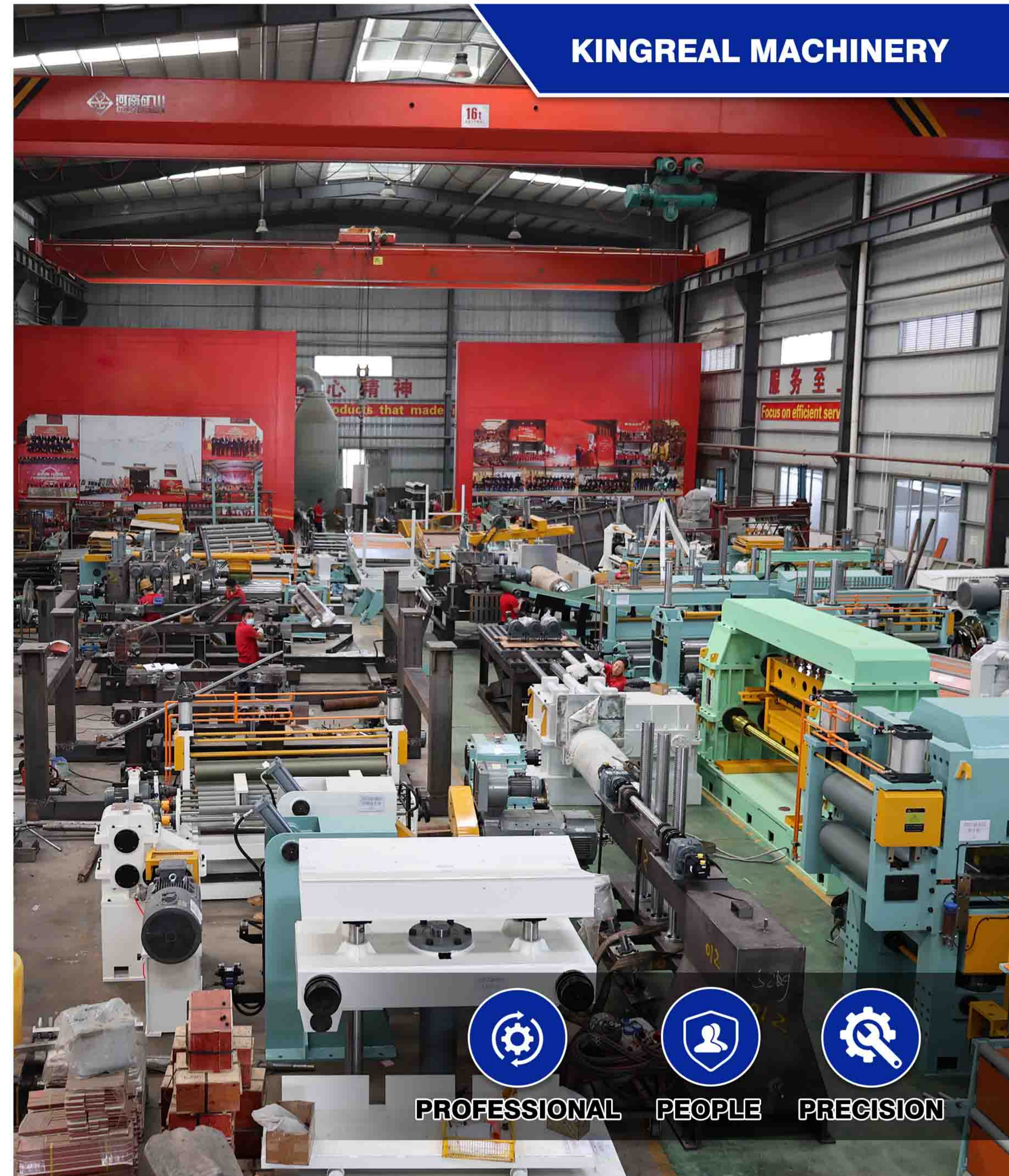
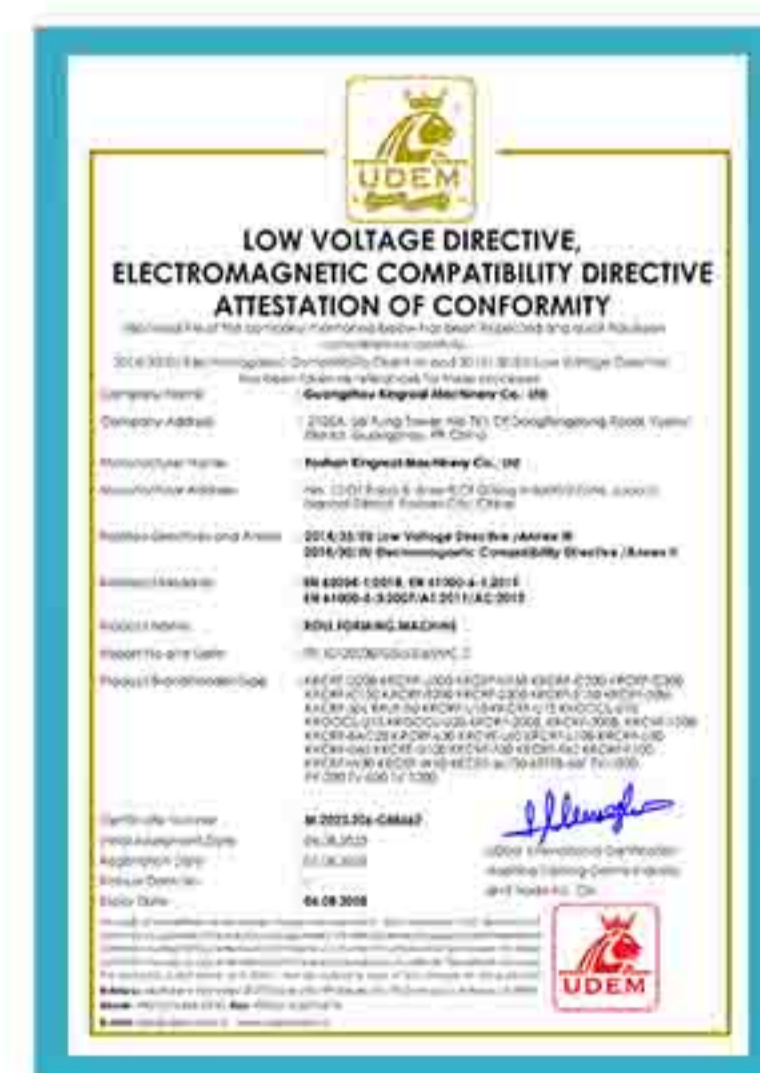

100+
TECHNICAL TALENTS

25+ YEARS
PRODUCTION EXPERIENCE

30+
INVENTION &
UTILITY MODEL PATENTS

PROFESSIONAL PEOPLE PRECISION



CLASSIFICATION		
LIGHT-GAUGE	MEDIUM GAUGE	HEAVY-GAUGE
0.2-3.0MM	3.0-6.0MM	6.0-16MM



HIGH-SPEED DUAL-SLITTER HEAD

COIL SLITTING LINE

双刀座分条机

REFERENCE DRAWING

参考图纸

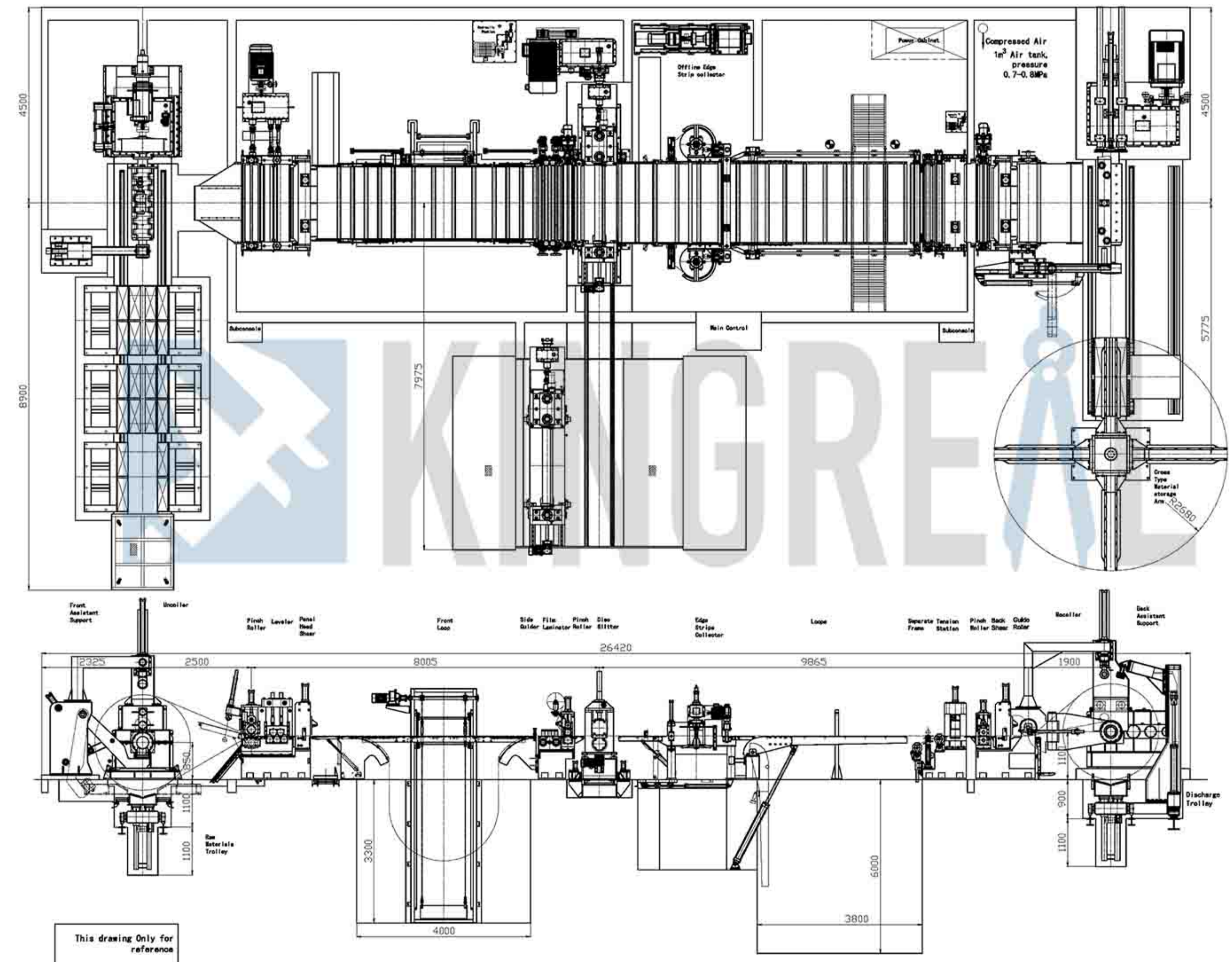

INTRODUCTION

DOUBLE TOOL HOLDER STRUCTURE; THE TOOLS CAN BE LOADED AND LOADED AT THE SAME TIME DURING THE PRODUCTION LINE TO IMPROVE WORK EFFICIENCY.

双刀座结构；生产线工作过程中可以同进装刀，提高工作效率

MACHINE DETAILS

MACHINE FEATURES	
200M/MIN	TWIN SLITTERS FOR QUICK SWOPPING



METAL COILS SLITTING LINE WITH BELT BRIDLE TENSION UNIT

皮带张力机

REFERENCE DRAWING

参考图纸

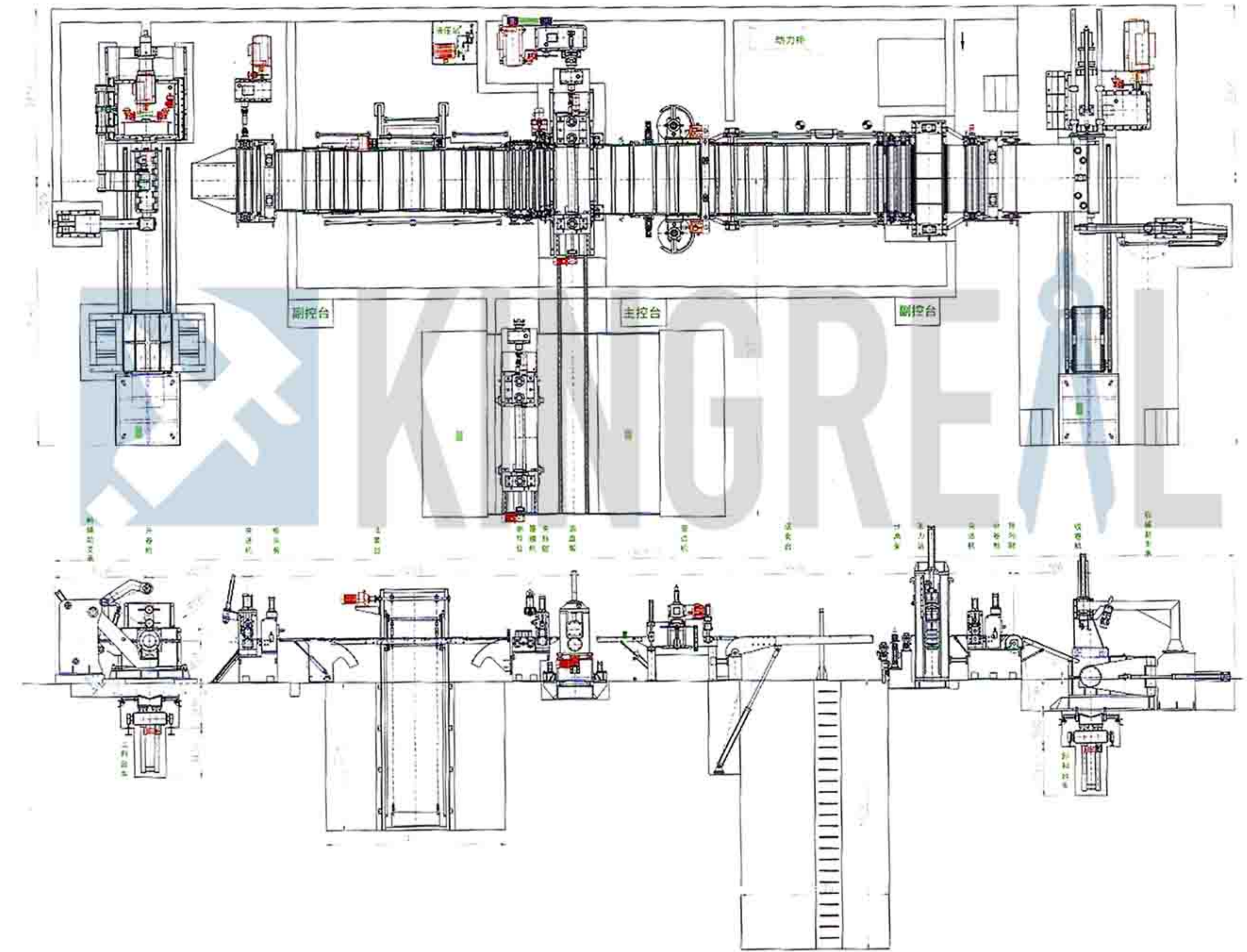

INTRODUCTION

SUITABLE FOR CONFIGURATIONS WITH HIGH REQUIREMENTS ON COIL MATERIALS

适应在对卷材有高要求的纵剪线中。

MACHINE DETAILS



HEAVY GAUGE COIL SLITTING LINE

厚板分条机

MACHINE DETAILS

机器细节



INTRODUCTION

THIS COIL SLITTING LINE IS CAPABLE OF PROCESSING DIFFERENT MATERIALS SUCH AS COLD ROLLED STEEL COILS, HOT ROLLED CARBON STEEL COILS, STAINLESS STEEL COILS, COPPER, BRASS, ALUMINUM AND SUCH AS PRE-PAINTED STEEL COILS. CAN ACCURATELY SLIT VARIOUS ROLL MATERIALS WITH A THICKNESS OF 6-16MM

该卷材纵剪线能够加工不同材质的冷轧钢卷、热轧碳钢卷、不锈钢卷、铜、黄铜、铝以及彩涂钢卷等。可精准分条厚度6-16MM厚的各种卷材。



MACHINE FEATURES

THICKNESS: 6.0-16MM

NUMBER OF STRIPS: 2-6

SIMPLY COIL SLITTING LINE

简易分条机

REFERENCE DRAWING

参考图纸

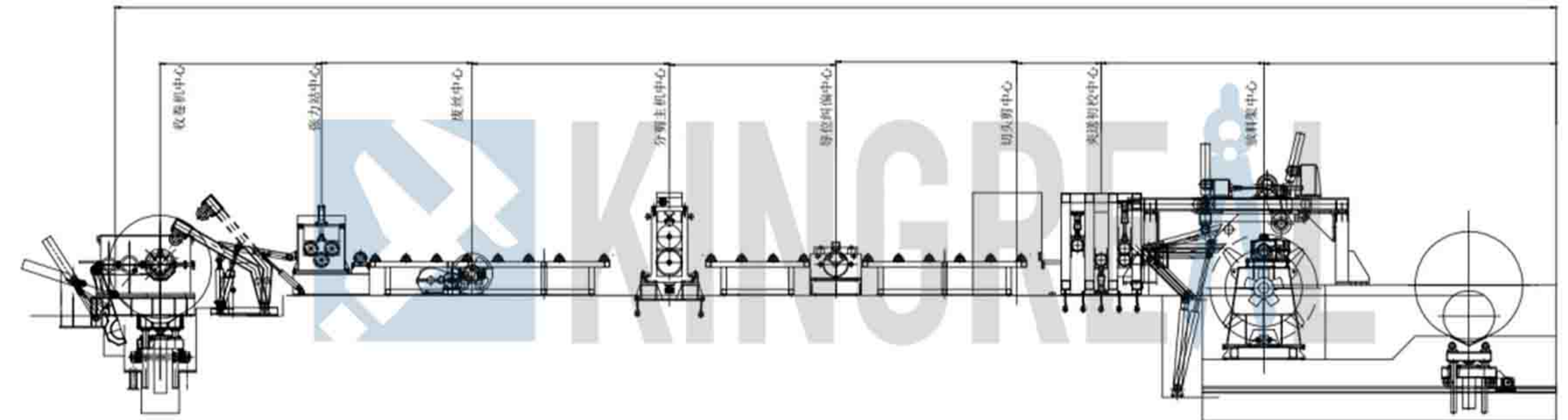

MACHINE DETAILS



INTRODUCTION

MEET BASIC SLITTING MACHINE PRODUCTION REQUIREMENTS

满足基本的分条机生产需求。



// PARTS DISPLAY //

零件展示

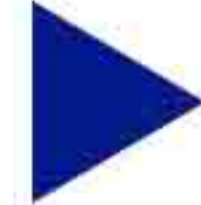
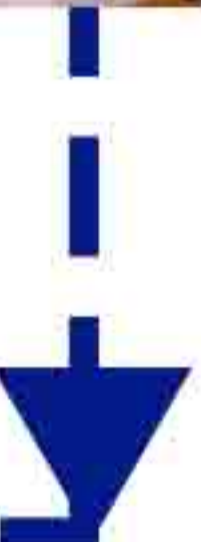



CLASSIFICATION		
LIGHT-GAUGE	MEDIUM GAUGE	HEAVY-GAUGE
0.2-3.0MM	3.0-6.0MM	6.0-16MM



FLY SHEARING CUT TO LENGTH LINE WITH DUAL PRECISION STRAIGHTENING MACHINE

双整平飞剪线

REFERENCE DRAWING

参考图纸

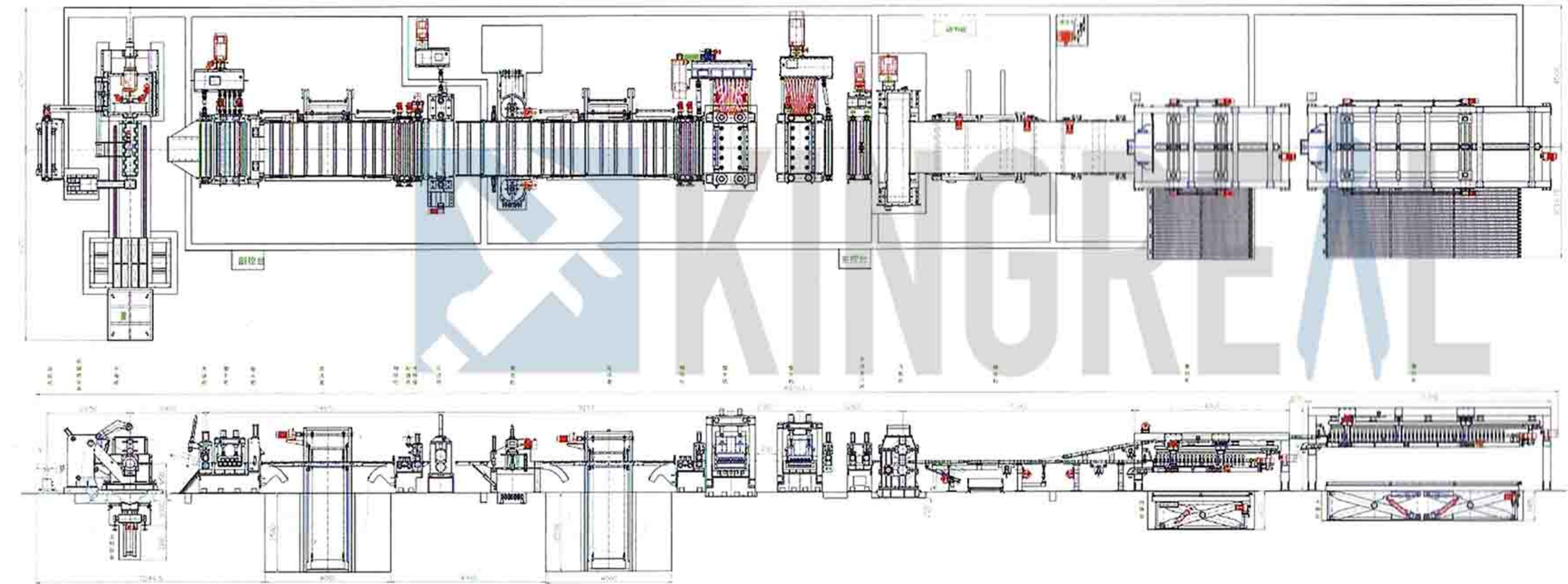

MACHINE DETAILS

INTRODUCTION

THERE ARE A TOTAL OF 21 WORK ROLLERS, 4 CYLINDER ROLLERS, 23 INTERMEDIATE ROLLERS, AND 5 SETS OF UPPER AND LOWER SUPPORTING ROLLERS IN THE LEVELING MACHINE. THE DUAL LEVELING MACHINE CONFIGURATION CAN PRECISELY LEVEL THE ROLLS WITH ROUGH AND UNEVEN SURFACES.

整平机中共有21个工作辊、4个夹紧辊、23个中间辊、上下各5组支撑上下辊。双整平机配置可对表面粗糙不平的卷材进行进行精密整平。

MACHINE FEATURES

80M/MIN

DUAL PRECISION STRAIGHTENING MACHINE



FIXED STATION SHEARING CUT TO LENGTH LINE

定剪剪板线

REFERENCE DRAWING

参考图纸

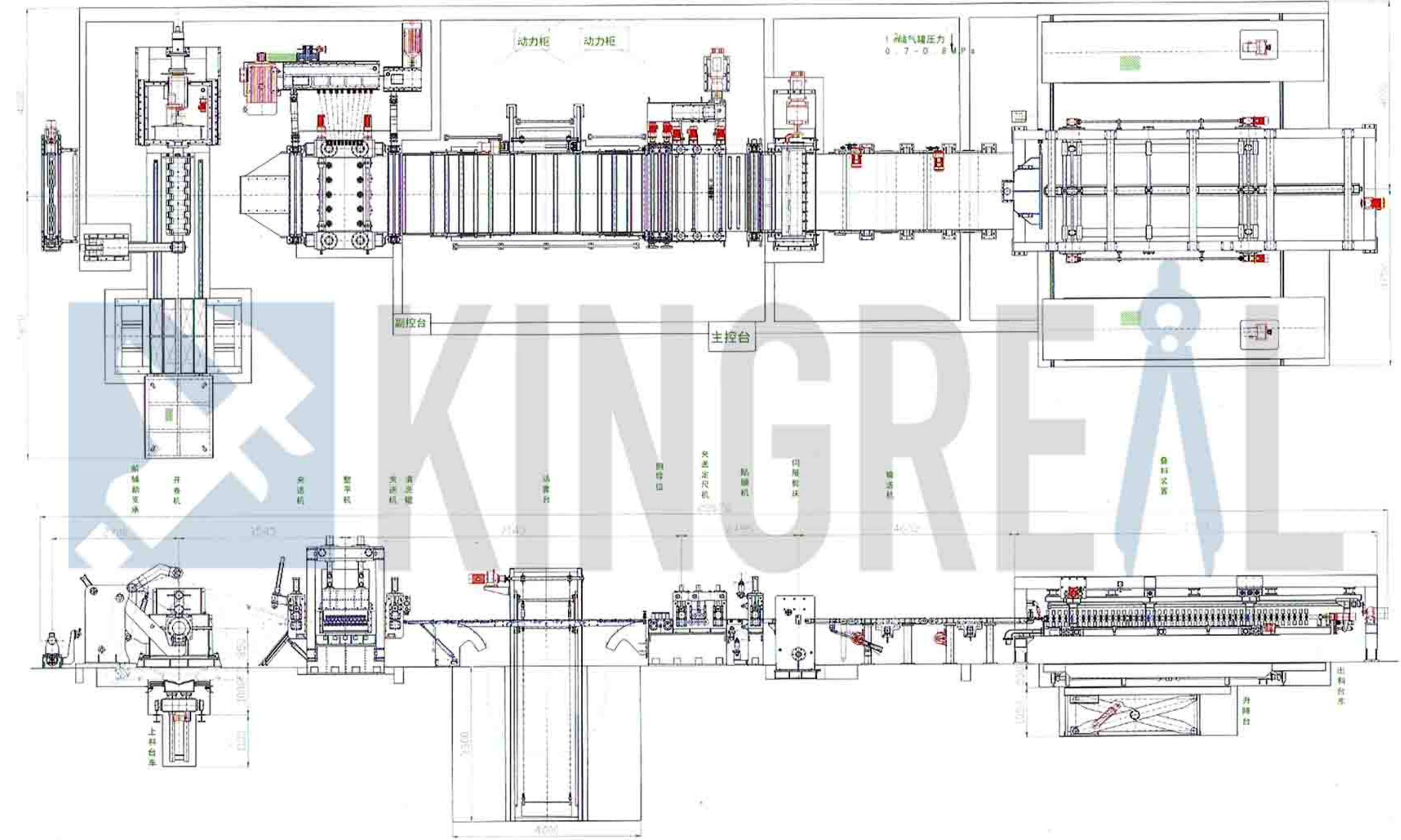

INTRODUCTION

USING STEPPER MOTOR FREQUENCY CONVERSION SPEED CONTROL, EFFICIENT OPERATION TO REDUCE ERRORS, SPEED 30M/MIN, STRAIGHT KNIFE CROSS-CUTTING IS ALSO SUITABLE FOR CUSTOMIZATION IN HEAVY-DUTY SHEARING LINES, SHEARING COILS WITH A THICKNESS OF 6-20MM

采用步进电机变频调速控制，高效运作减少出错，速度30M/MIN，直刀横切同时适用定制在重型剪板线中，剪厚度为6-20MM的卷材

MACHINE DETAILS

MACHINE FEATURES

30M/MIN

SUITABLE FOR HEAVY-GAUGE CUT TO LENGTH LINE



HEAVY GAUGE CUT TO LENGTH LINE

厚板剪板线

MACHINE DETAILS

机器细节



INTRODUCTION

THE TYPE OF SHEARING MACHINE IS HYDRAULIC GATE TYPE, AND THE BLADE MATERIAL IS CR12MOV. IT CAN ACCURATELY SHEAR VARIOUS COIL MATERIALS WITH A THICKNESS OF 6-20MM.

剪板机型式为:液压闸式, 刀片材质为: CR12MOV, 可精准剪切厚度6-20MM厚的各种卷材。



MACHINE FEATURES

THICKNESS: 6.0-20MM

8-12PCS/MIN



SIMPLY CUT TO LENGTH LINE

简易剪板线

REFERENCE DRAWING

参考图纸

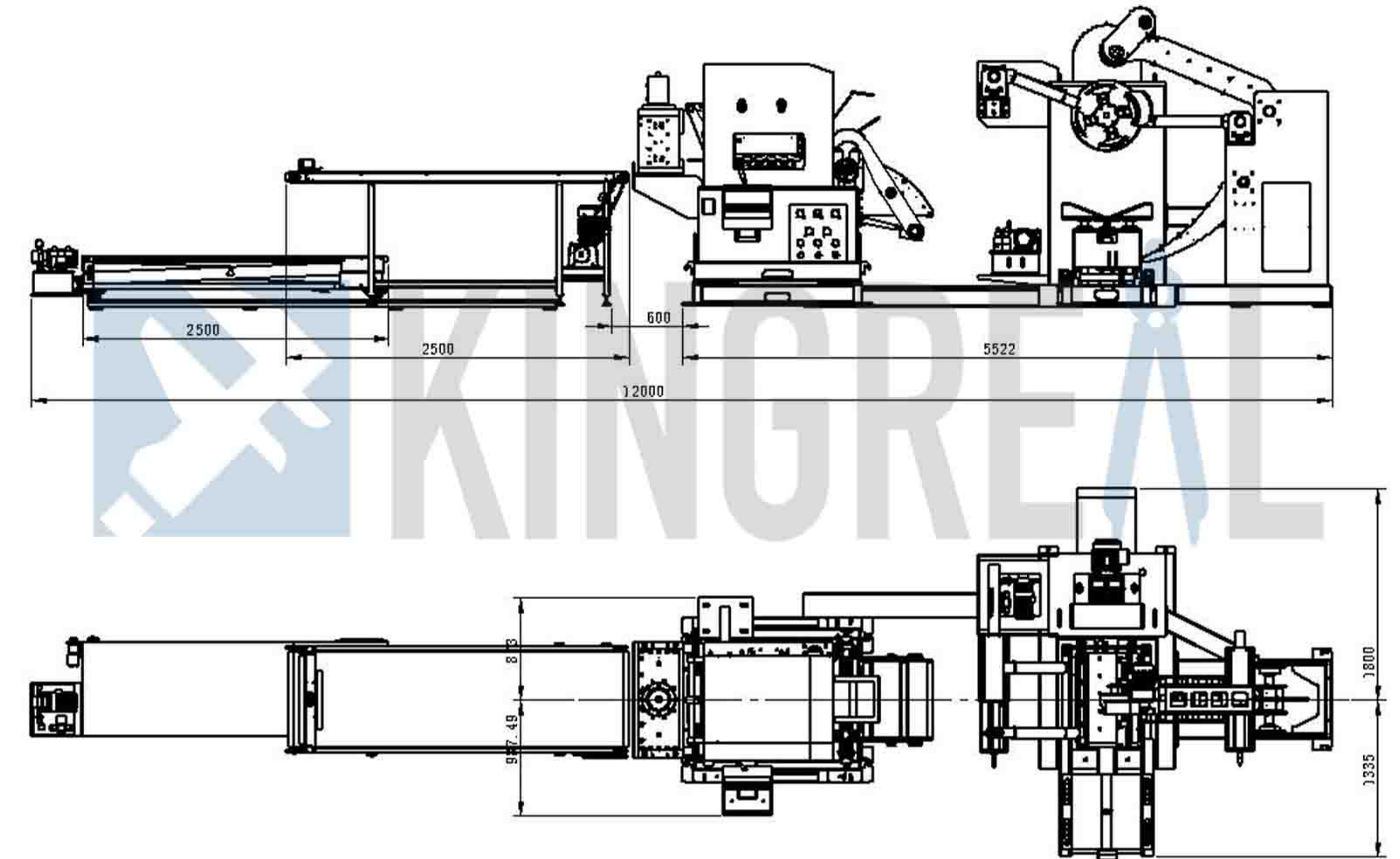

INTRODUCTION

THE PRODUCTION LINE CONSISTS OF FOUR PARTS: DECOILING - LEVELING - SHEARING - STACKING, WHICH CAN MEET BASIC PRODUCTION NEEDS.

生产线由开卷-整平-剪切-叠料，四个部分组成，可满足基本的生产需求。

MACHINE DETAILS

MACHINE FEATURES

0-30M/MIN ADJUSTABLE

MATERIAL OF COILS: CHROME STEEL, GALVANIZED IRON SHEET, GALVANIZED ALUMINUM SHEET



SWING SHEARING CUT TO LENGTH LINE

摆剪剪板线

MACHINE DETAILS

机器细节



INTRODUCTION

THE SWING SHEARING CUT TO LENGTH LINE CUTS COILED MATERIAL INTO SECTIONS OF THE REQUIRED LENGTH WITH IRREGULAR SHAPES THROUGH A SWING SHEARING DEVICE. IT IS TYPICALLY USED IN CUTTING BODY PANELS FOR THE AUTOMOTIVE INDUSTRY.

通过摆动剪切装置将卷材逐段切割成所需长度的不规则形状的板材。通常应用在车身板材的切割中



PARTS DISPLAY

零件展示

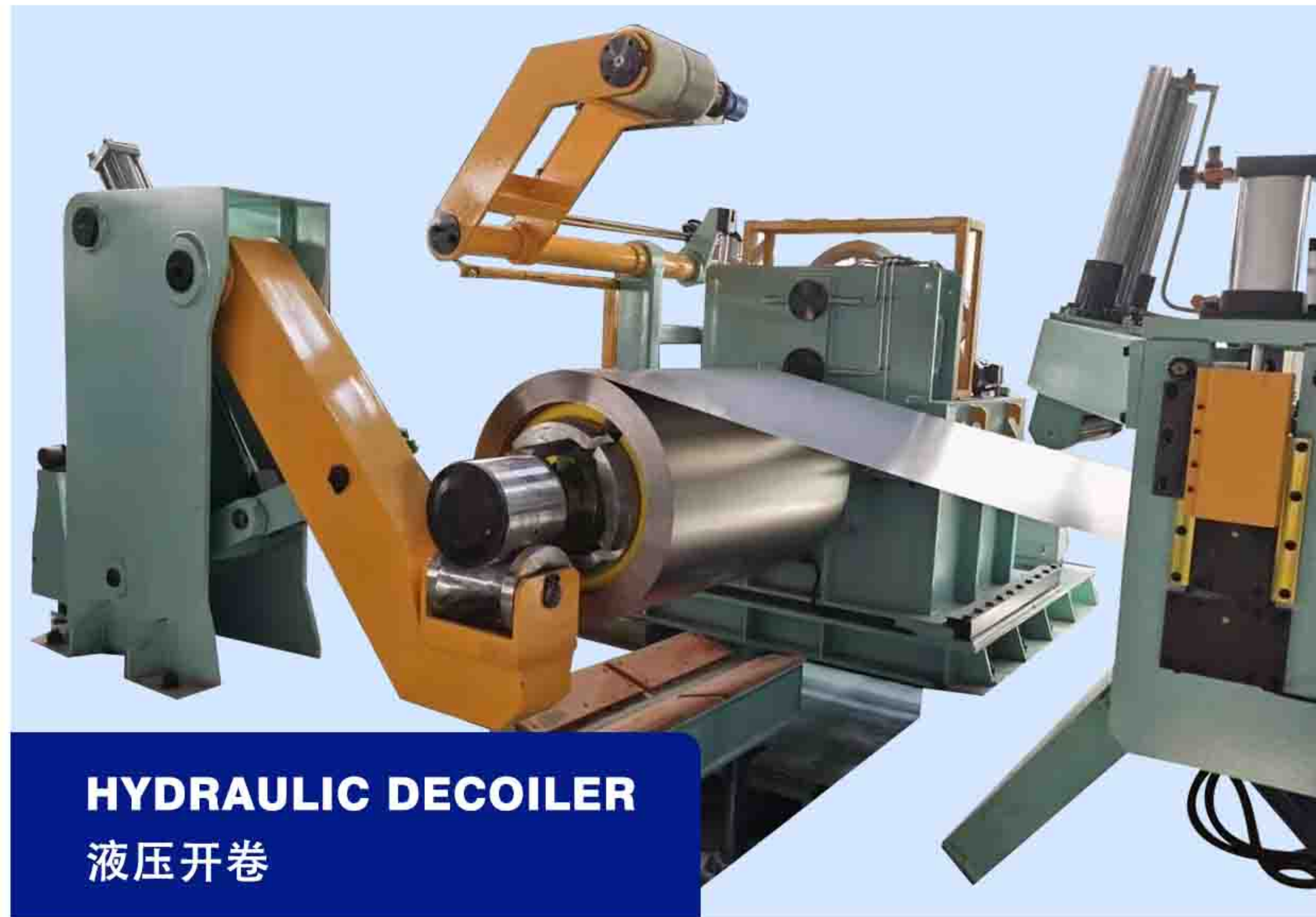

QUALITY CONTROL / QC质检

客户探厂 / **CUSTOMER VISITS**

► **MACHINE DEBUGGING**



INDONESIA



BENGAL



RUSSIA



SAUDI ARABIA



BRAZIL

► **KINGREAL EXHIBITION**

打包发货 / **PACKING&SHIPPING**

METALLOBRABOTKA 2023



THE 134th CANTON FAIR



THE 135th CANTON FAIR

