

尺寸: 120*85MM
正反折页

Handheld Industrial Endoscope

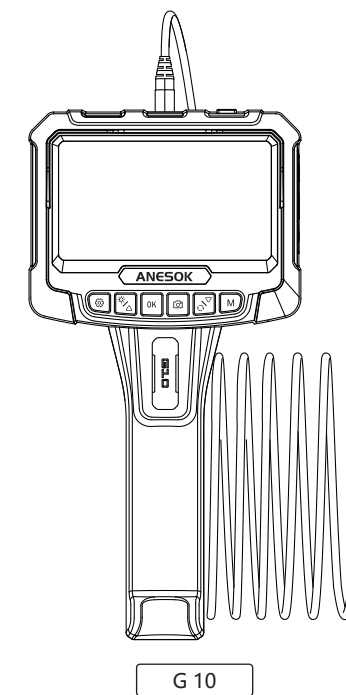

G 10

Product Description

G 10 is a high-performance industrial endoscope camera with 5 inch HD color display. It adopts ergonomic design, which makes it easy to operate. Self-storage, support for photo and video functions, also the TF card expansion function (up to 64G). This product is equipped with a small diameter HD camera with LED auxiliary lighting. The camera adopts a high-sensitivity chip, which can be used normally even in a dark working environment.

Safety and Maintenance

- The product is an industrial endoscopy camera and is not intended for medical use or human examination.
- Do not hit the camera violently and do not pull the cable.
- When used in an environment with sharp bumps, please use it carefully to prevent the waterproof protective layer of the probe from being scratched.
- The camera probe is not made of heat-resistant and high-temperature materials. When checking the automobile engine, please ensure that the temperature in the engine drops to the normal temperature.
- When not in use, please ensure that the lens and the main unit are clean and dry, and avoid contact with oil, etc. or other corrosive and dangerous substances.
- This product is not suitable for people with limited physical, sensory or mental abilities.
- Do not allow children to touch and operate this equipment.

Battery instructions

- Please use a 5V household charger that meets the safety regulations to charge the equipment. Fast charging is not supported.
- This device supports charging while using.
- If the device is not used for a long time, please ensure that it is charged at least once every 3 months to prevent irreparable damage caused by excessive discharge of the battery.

Function introduction

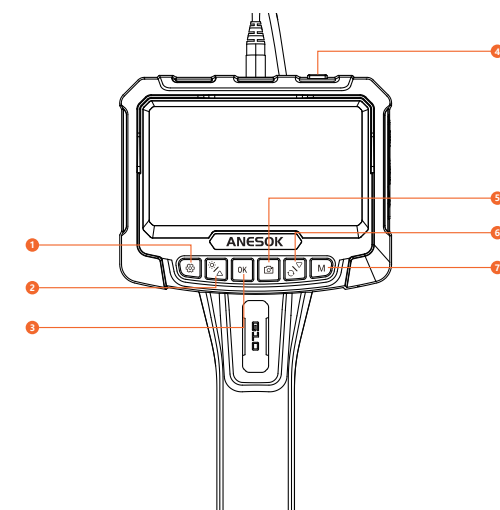

- Setting key: ① Enter ② Exit the setting interface
- Up selection key: ① Up ② Adjust the brightness of the camera LED ③ Video playback fast forward key ④ Zoom in
- Enter: ① Confirm selection ② Image fixed
- Switch: ① Press and hold for 3 seconds to turn on/off
- Taking photos: ① Short press to take photos ② Start recording ③ End recording ④ Long press to switch camera
- Down selection key: ① Scroll down ② Picture rotation ③ Video playback
- Mode switching: ① Switch between 3 function modes of take photo, video and photo album

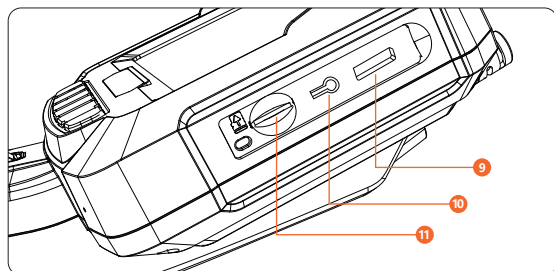

8.Charging interface 9.Reset 10.TF card slot

Instructions

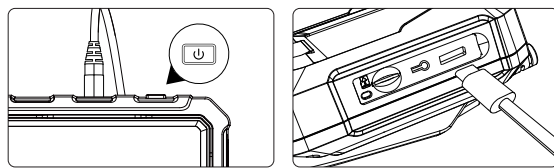

Long press "P" for 3 seconds to power on / off Use the type-C charging cable to charge the device

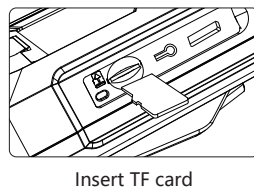

Insert TF card

- Insert TF card:**
- Please insert the TF card in the off state
 - Please pay attention to whether the insertion direction and front and back sides of TF card are correct
 - Do not use excessive force when inserting or pulling out the TF card to prevent damage to the card slot structure

Language settings

The default language is English, and the system also supports Simplified Chinese, Japanese, English, Korean, French, German, Italian, Spanish, Russian, Polish

- Press " " button to enter the setting page
- Select the language setting
- Press the up and down button to select the desired language
- Press "OK" to save

Enter the picture outputting interface

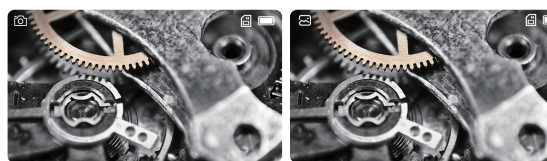

- Press "M" to switch to take photo or video, press " " to take photo or video.
- Press "M" to switch to photo album viewing, select the photo or video that you want to view, press " " to delete the photo or video.

Copy picture and video files

Can use a TF card to copy directly, or use a type-c cable to connect to computer for copy

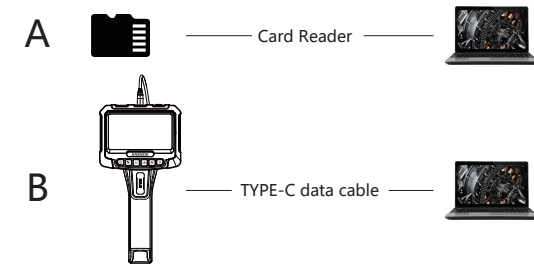

When operating the copy, if the machine is not connected to the computer, please restart the machine or plug and unplug the TYPE-C data line. Do not plug and unplug the TYPE-C data cable during the data transmission process, which will cause the data transmission to fail.

Charging Guide

- Connect the device to the TYPE-C USB adapter for charging (5V=1A/5V=2A). The product does not support fast charging.
- (1) During the charging process, the power symbol indicates that the charging is in progress; (2) When the device is fully charged, the power display shows the full state

FAQ

- The product does not output a picture or the screen turns black**
Remove the flexible conduit joint, reassemble and tighten it, or restart the device.
- Lags happened during the photo outputting of the product**
Please check whether the product has sufficient power, or restart the device, or reassemble the flexible conduit.
- Product crash**
Please press the reset button on the back of the device, restart the device.
- Imaging screen is not clear**
The best imaging focal length of the product is: 2cm-10cm, please calibrate the distance to the object, or clean the front of the camera with a clean alcohol cloth.
- Product charging**
Please use (5V=1A/5V=2A) charger to charge the device. The product does not support fast charging.
- The camera is heat**
It is normal for the camera to heat up, especially when the camera LED light is on at the highest brightness. But it does not affect normal use or service life.
- TF card can not be recognized**
Please confirm whether the TF format is FTA32. If not, please format it and do not recognize it. Please plug and unplug the TF card again

Accessories installation Guide

Accessories: Protective ring*1, Magnet *1, Hook *1

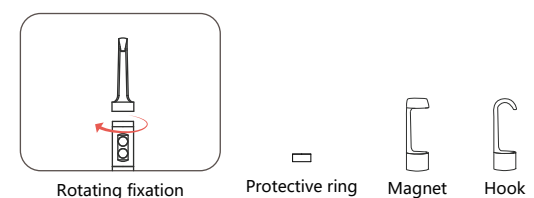

Camera

	Dual lens		Single lens	
Camera diameter	8mm	5.5mm	8mm	5.5mm
Camera resolution	2 Megapixels			
Viewing angle	78°		70°	
Auxiliary lighting	8+1 Einstellbare Helligkeits-LEDs		8 Einstellbare Helligkeits-LEDs	
Fokussier-bereich	A Camera	20-100mm	20-100mm	
	B Camera	20-50mm		

Other

Operating temperature: 32°F-113°F(0°C-45°C)	Battery: 2000mAh
Battery life: 3 hours	Battery charging time: 2.5 hours
List: endoscope, manual, TYPE-C charging cable, accessories container, Protective ring, Hook, Magnet	

Specifications

Screen type: 5.0-inch color display	Screen resolution: 1280 * 720
Support camera probe resolution: 2 MP	Photo resolution: 1920*1080
Video resolution: 1280*720	Port: TYPE-C charging port

