

MECHANICAL DIMENSION

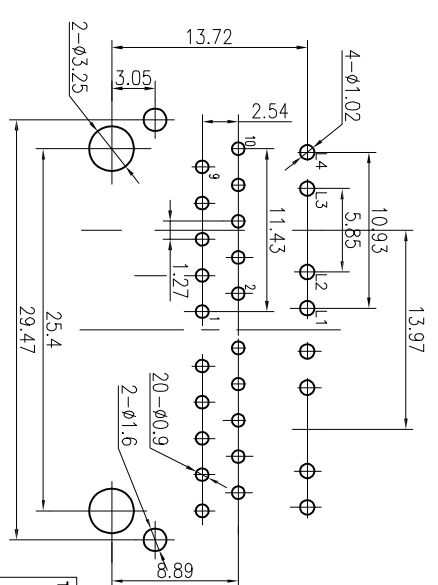
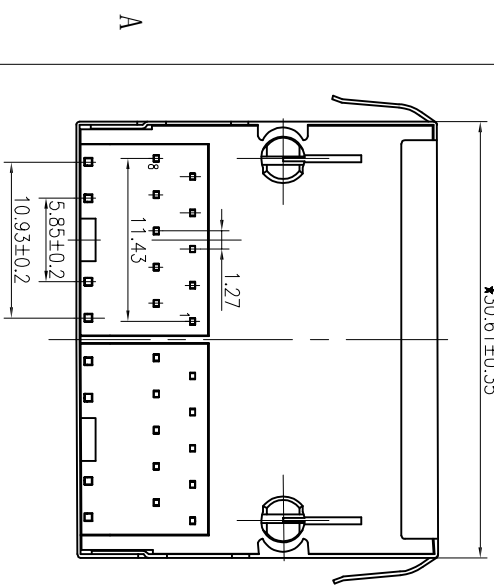
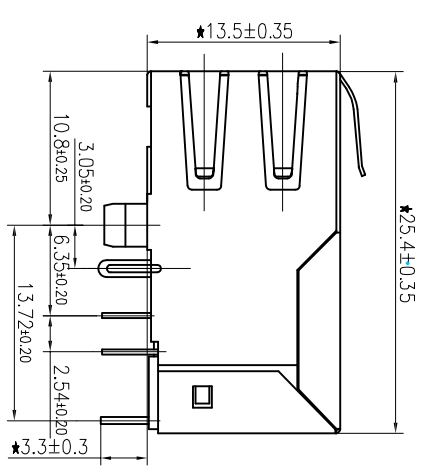
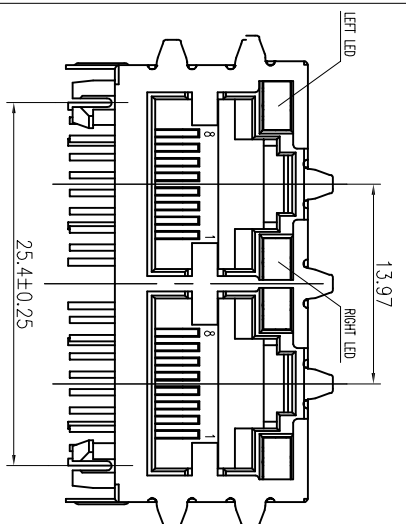

1. MATERIALS AND FINISH

HOUSING: PA9T (GLASS FILLED POLYESTER UL94V-0)
 CONTACT: PHOSPHOR BRONZE T=0.35MM FLAT PIN
 PLATING: 6 U" GOLD PLATING OVER NICKEL
 SHIELD: 0.20MM THICKNESS COPPER ALLOY WITH NICKEL PLATED
 PCB RETENTION PRE-SOLDER: 1LB MIN.
 PCB RETENTION POST-SOLDER: 10 LBS MIN.
 TAILS: 150U"~200U" TIN-LEAD MIN OVER30U"~50U" NICKEL (ROHS6)

2. MECHANICAL CHARACTERISTICS

DURABILITY: 750 (MODULAR JACK) INSERTION/PLUG DIMENSION CYCLES AT MIN. RATE OF 120 CYCLES PER MINUTE.

3. ELECTRICAL

CONTACT RESISTANCE: 30 MILLIOHMS MAX.
 INSULATION RESISTANCE: 500 MEGOHMS MIN. @500 VDC.
 DIELECTRIC STRENGTH: 1500 VAC RMS 60HZ, 1MIN.

4. ENVIRONMENTAL

OPERATING TEMPERATURE: 0°C~+70°C
 STORAGE TEMPERATURE: -40°C~+85°C

5. DESIGN AND CONSTRUCTION
 COMPLIES WITH IEEE802.3 STANDARDS AND ALL 10/100/1000 ETHERNET SPECIFICATIONS
 MATES WITH MODULAR PLUG CONFORMING TO FCC PACT 68 SUBPART F.

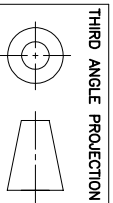

THIRD ANGLE PROJECTION

DO NOT SCALE DRAWING
 DRAWING IS SUBJECT TO CHANGE WITHOUT NOTICE
 DIMENSIONS: mm(INCH)
 .X±0.20 .XXX±0.10
 .XX±0.15
 SHEET NO. 1 OF 2

JAN 东莞市建旭电子有限公司
 JANSUM ELECTRONICS (DONGGUAN)CO.,LTD
[Http://www.jansum.cn](http://www.jansum.cn)

PART NO:		G121001Y	
TITLE		RJ45 1X2 TAP UP 1G WITH LED	
DRW BR:	ZHANGYANBIN	DATE:	2021/3/17
APP BR:	SUXIANHE	DATE:	2021/3/17
DWG NO:	JX-01	REV:	A/0



SCHEMATIC:

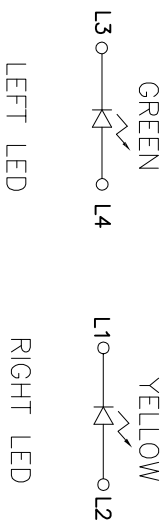
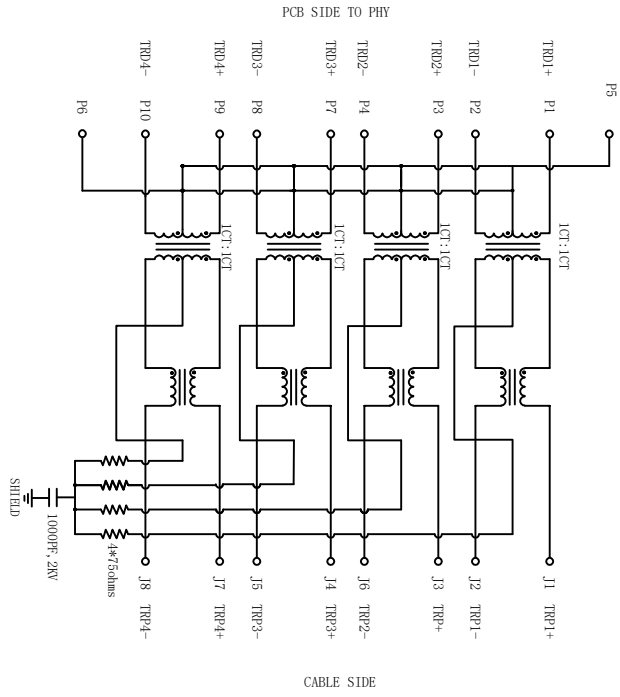

- ELECTRICAL CHARACTERISTICS @ 25°C
1. ELECTRICAL SPECIFICATIONS: @ 25°C
- 1.1 ISOLATION VOLTAGE: 1500V/AC (INPUT TO OUTPUT)
 - 1.2 OCL: 350ΩH MINIMUM @100KHZ 100WV 8MA DC
 - 1.3 INSERTION LOSS: -1.2DB MAXIMUM @100KHZ-100MHZ)
 - 1.4 RETURN LOSS: -18DB MINIMUM @1MHZ-30MHZ
-14DB MINIMUM @30MHZ-60MHZ
-12DB MINIMUM @60MHZ-80MHZ
-10DB MINIMUM @80MHZ-100MHZ
 - 1.5 COMMON MODE REJECTION: -30DB MINIMUM @1MHZ-100MHZ
 - 1.6 GROSS TALK: -30DB MINIMUM @1MHZ-100MHZ

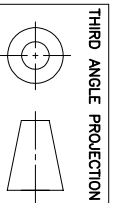

JAN 东莞市建旭电子有限公司
JANSUM ELECTRONICS (DONGGUAN)CO.,LTD
Http://www.jansum.cn

DO NOT SCALE DRAWING
DRAWING IS SUBJECT TO CHANGE WITHOUT NOTICE
DIMENSIONS: mm(INCH)
X±0.20 XXX±0.10
XX±0.15
SHEET NO. 2 OF 2



PART NO: G121001Y		DATE: 2021/3/17	
TITLE: RJ45 1X2 TAP UP 1G WITH LED		APPD BY: SUXIANHE	
Address: 6-7/F, No. 82, Jinhe 1st Road, Jinmei Village, Chongming Town, Dongguan City, Guangdong, China		DATE: 2021/3/17	
E-mail: jsales@jansum.cn		REV: A/0	
Tel: +86-769-86299641		DWG NO: JX-02	