



32.5×27.6×20.5

NT90 (50A)



Features
<ul style="list-style-type: none"> 50A contact switching capability. The temperature rise is <80K under 70°C. Terminal width 1.8mm and 3.3mm available. PC board mounting available. PV power, UPS power, charger, electric car, electric equipment, air conditioner, etc.

Ordering Information	
<p>NT90 R 50 A S 24 S F .9</p> <p>1 Part number: NT90 2 Terminal: R: without Pin 6; Nil: with Pin 6; W: 3.3mm 3 Load: 50:50A 4 Contact arrangement: A: 1A; B: 1B; C: 1C 5 Enclosure: S: Wash tight¹; E: Flux proof</p>	<p>6 Coil rated voltage(V): DC: 5, 6, 9, 12, 15, 18, 24, 48 AC: 24, 110, 120, 220, 240, 277 7 Contact material: S: AgSnO₂ 8 Resist heat class: F: 15570°C 9 Coil Power(W): .9: 0.9W; NIL: 1.5W&2.7VA</p>

¹Wash tight plastic case with knock off nib.

Contact Data

Contact Arrangement	1A(SPSTNO) 1B(SPSTNC) 1C(SPDT(B-M))	
Contact Material	AgSnO ₂	
Contact Rating ² (Resistive)	NO: 50A/240VAC; NC: 35A/240VAC; NO: 35A/30VDC; NC: 25A/30VDC; Motor Load: 2HP 250VAC; TV-8	
Max. Switching Power	1050W 12000VA	
Max. Switching Voltage	30VDC 280VAC	Max. Switching Current: 50A
Contact Resistance	≤ 30mΩ	Item 4.12 of IEC 61810-7
Operation Life	Electrical	3 × 10 ⁴ (50A/277VAC, Resistive load, 40°C 1s on 9s off) 6 × 10 ³ (50A/277VAC, Resistive load, 85°C 1s on 9s off) 3 × 10 ⁴ (35A/277VAC, Resistive load, 40°C 1s on 9s off) 2.5 × 10 ⁴ (TV-8)
	Mechanical	1 × 10 ⁷ Item 4.31 of IEC 61810-7

²Remove vent nib after soldering and cleaning.

Coil

Coil Power	DC	AC
	0.9W; 1.5W	2.7VA

NT90(50A)

Coil Parameter

DC Coil Parameter								
Dash numbers	Rated voltage VDC		Coil resistance $\Omega \pm 10\%$	Pick-up voltage V(max) (75%of rated voltage)	Drop-out voltage V(min) (10%of rated voltage)	Coil power W	Operate time ms	Release time ms
	Rated	Max						
005-900	5	6.5	28	3.75	0.5	0.9	≤ 15	≤ 10
006-900	6	7.8	40	4.50	0.6			
009-900	9	11.7	90	6.75	0.9			
012-900	12	15.6	160	9.00	1.2			
015-900	15	19.5	250	11.25	1.5			
018-900	18	23.4	360	13.50	1.8			
024-900	24	31.2	640	18.00	2.4			
048-900	48	62.4	2560	36.00	4.8			
005-1500	5	6.5	16.7	3.75	0.5	1.5	≤ 15	≤ 10
006-1500	6	7.8	24	4.50	0.6			
009-1500	9	11.7	54	6.75	0.9			
012-1500	12	15.6	96	9.00	1.2			
015-1500	15	19.5	150	10.25	1.5			
018-1500	18	23.4	216	13.50	1.8			
024-1500	24	31.2	384	18.00	2.4			
048-1500	48	62.4	1536	36.00	4.8			

AC Coil Parameter									
Dash numbers	Rated voltage VAC		Rated current mA	Coil resistance $\Omega \pm 10\%$	Pick-up voltage V(max) (75%of rated voltage)	Drop-out voltage V(min) (10%of rated voltage)	Coil power VA	Operate time ms	Release time ms
	Rated	Max							
024AC-2700	24	28.8	112.5	96	18	7.2	2.7VA	—	—
110AC-2700	110	132	24.5	2320	82.5	33			
120AC-2700	120	144	22.5	2800	90	36			
220AC-2700	220	264	12.3	9500	165	66			
240AC-2700	240	288	11.3	11600	180	72			
277AC-2700	277	332	9.7	15600	208	83			

CAUTION: 1.The use of any coil voltage less than the rated coil voltage will compromise the operation of the relay.
2.Pickup and release voltage are for test purpose only and are not to be used as design criteria.

Safety Approvals

Safety approval	UL&CUR	TÜV	CQC
Load	NO: 50A/240VAC,277VAC 85°C NC: 35A/240VAC,277VAC 40°C	NO:50A/240VAC 40°C NC:35A/240VAC 40°C	NO:50A/240VAC 40°C NC:35A/240VAC 40°C

Characteristics

Insulation Resistance	1000M Ω min (at 500VDC)	Item 4.11 of IEC 61810-7
Dielectric Strength Between Contacts Between Contact and Coil	50Hz 1500V 50Hz 2500V 4000V(without pin 6)*	Item 4.9 of IEC 61810-7 Item 4.9 of IEC 61810-7
Shock Resistance	Functional: 98m/s ² 11ms	Item 4.26 of IEC 61810-7
	Destructive: 980m/s ² 11ms	Item 4.26 of IEC 61810-7
Vibration Resistance	10Hz~55Hz Double amplitude 1.5mm	Item 4.28 of IEC 61810-7
Terminals Strength	10N	Item 4.24 of IEC 61810-7
Ambient Temperature	-55°C~85°C	
Relative Humidity	5% to 85%	Item 4.16 of IEC 61810-7
Mass	27g	Item 4.7 of IEC 61810-7

* Please contact with the sales personnel for the 4000VAC version.

Dimensions

mm

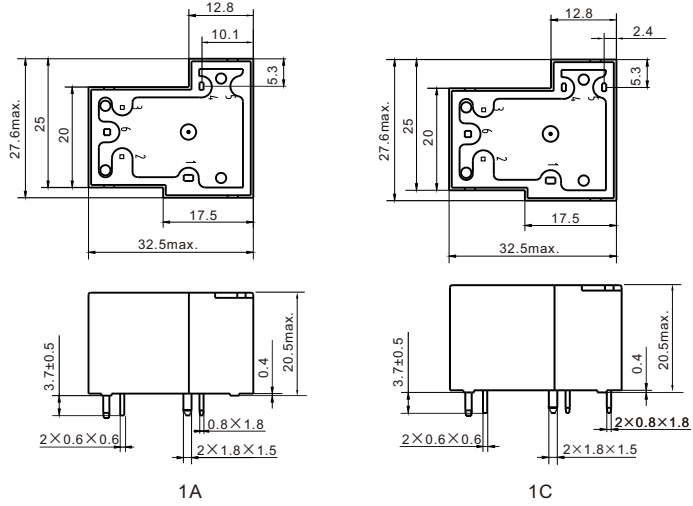

1A

1C

1.8mm
Dimensions

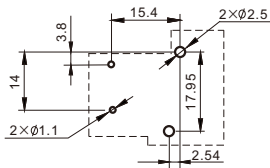

Without pin 6

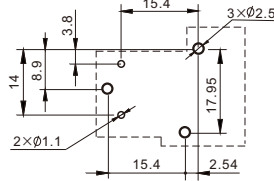

With pin 6

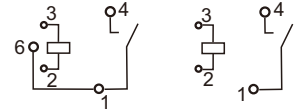

With pin 6

Without pin 6

1A 1.8mm

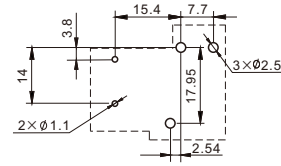

Without pin 6

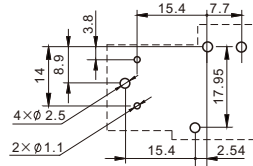

With pin 6

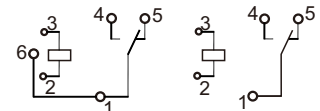

With pin 6

Without pin 6

1C 1.8mm

Wiring diagram(Bottom view)

Mounting (Bottom view)

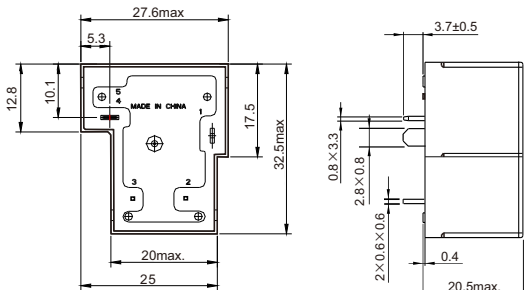

3.3mm
Dimensions

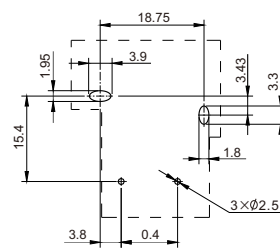

3.3mm
Wiring diagram(Bottom view)

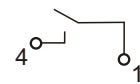

1A 3.3mm
Mounting (Bottom view)

CAUTION: In case of no tolerance shown in outline dimension: outline dimension $\leq 1\text{mm}$, tolerance should be $\pm 0.2\text{mm}$; outline dimension $> 1\text{mm}$ and $\leq 5\text{mm}$, tolerance should be $\pm 0.3\text{mm}$; outline dimension $> 5\text{mm}$, tolerance should be $\pm 0.4\text{mm}$.