

AIR FRYER OVEN

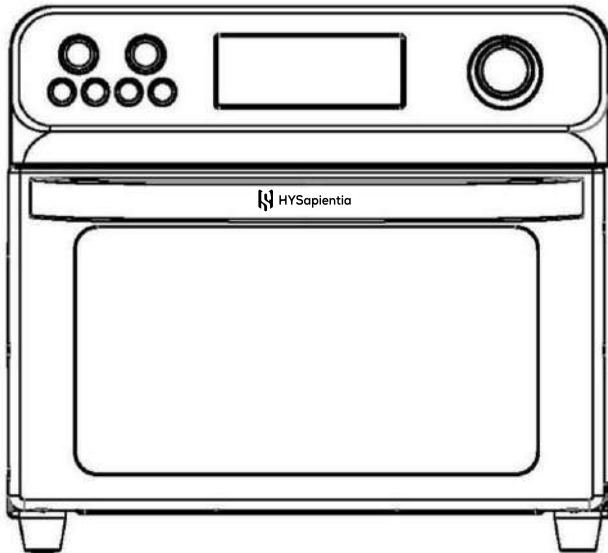

HYS-AFO-01A

USER MANUAL

USER MANUAL

Important Safeguards.....	3-5
Know Your Air Fryer Oven.....	6-7
Before First Use.....	8
Using Your Air Fryer Oven.....	9-10
Convection Tips.....	11
Troubleshooting.....	12
Cleaning&Maintenance.....	13

QUICK GUIDE

How To Set.....	14-16
Accessories Instructions.....	17-22
Accessories Combination.....	23-24
About HYSapientia Air Fryer Oven.....	25
Frequently Asked Questions.....	26

IMPORTANT SAFEGUARDS

When using electric appliances, basic safety precautions should always be followed:

1. Read all instructions.
2. This appliance is not intended for use by persons (including children younger than 8) with reduced physical, sensory or mental capabilities, or lack of experience and knowledge, unless they have supervision.
3. Check if the voltage indicated on the appliance corresponds to the local main voltage before you connect the appliance.
4. **Do not** use the appliance if the plug, the main cord or the appliance itself is damaged. Always make sure that the plug is inserted properly into a wall outlet.
5. **Do not** operate any appliance with a damaged cord or plug, after the appliance malfunctions, or has been damaged in any manner. Return appliance to the nearest authorized service facility for examination, repair, or adjustment.
6. Close supervision is necessary when any appliance is used near children. Children should be supervised to ensure that they do not play with the appliance. Cleaning and user maintenance shall not be done by children unless they are older than 8 and supervised.
7. **Do not** let the cord hang over the edge of the table or counter or touch hot surfaces.
8. To protect against electric shock, **do not** immerse cord, plugs, or appliance in water or other liquid. **Do not** plug in the appliance or operate the control panel with wet hands.
9. **Never** connect this appliance to an external timer switch or separate remote-control system in order to avoid a hazardous situation. To disconnect, turn off the appliance, then remove plug from wall outlet.
10. **Do not** place the appliance on or near combustible materials such as a tablecloth or curtain. The accessible surfaces may become hot during use. **Do not** place on or near a hot gas or electric burner, or in a heated oven.
11. **Do not** place the appliance against a wall or against other appliances. Leave at least 4 inches of free space on the back and sides and 4 inches of free space above the appliance. **Do not** place anything on top of the appliance.
12. **Do not** use the appliance for any other purpose than described in this manual. The use of accessory attachments not recommended by the appliance manufacturer may cause injuries.
13. **Do not** let the appliance operate unattended. Extreme caution must be used when moving an appliance containing hot oil or other hot liquids.
14. **Do not** use outdoors.
15. **Do not** touch hot surfaces and

the air outlet on the back; use the handle. During air frying, hot steam is released through the air outlet. Keep your hands and face a safe distance from steam and vents. Also be aware of hot steam and air when removing the air conditioner. Pan from device.

16. After using the appliance, avoid contact with the hot metal inside. Unplug from outlet when not in use and before cleaning. Allow to cool before cleaning the appliance.
17. Immediately unplug the appliance if you see dark smoke coming out of the appliance. Wait for the smoke emission to stop before you remove the pan from the appliance.
18. **Do not** use appliance for other than intended use.
19. Use extreme caution when removing tray or disposing of hot grease.
20. **Do not** clean with metal scouring pads. Pieces can break off the pad and touch electrical parts, creating a risk of electric shock.
21. Oversize foods or metal utensils must not be inserted in a toaster-oven as they may create a fire or risk of electric shock.
22. A fire may occur if the toaster-oven is covered or touching flammable material, including curtains, draperies, walls, and the like, when in operation. **Do not** store any item on top of the

appliance when in operation.

23. Extreme caution should be exercised when using containers constructed of anything other than metal or glass.
24. **Do not** store any materials, other than manufacturers recommended accessories, in this oven when not in use.
25. **Do not** place any of the following materials in the oven: paper, cardboard, plastic, and the like.
26. Turn off the appliance by pressing **START/STOP**.
27. For household use only.
28. It is recommended that you wear oven mitts and use the included tray handles to remove cooked food.
29. After the oven is finished, the fan will continue to work to achieve the effect of heat dissipation. When the oven door is opened after cooking, please do not put your face close to the oven to avoid being burned by the hot air.
30. Choose suitable accessories according to different cooking purposes.
Please remove the grill pan, grill or air fryer basket when all accessories are cool.
31. **Do not** heat plastic, wood glass, glazed china, beverage cans and nonfood items in the oven.

SAVE THESE INSTRUCTIONS

32. The air fryer does not have a microwave function, so if you want to heat food, you can wrap it in tin foil and heat it at 100°C.

33. Do not use this product near showers, bathtubs, washbasins, swimming pools, etc. **Do not** rinse this product with water.

CORD SAFETY

- A short power-supply cord is provided to reduce risk of becoming entangled in or tripping over a longer cord.
- Extension cords may be used if care is exercised in their use.
- If an extension cord is used:
 - a. The marked electrical rating of the extension cord should be at least equal to the electrical rating of the appliance; and
 - b. The longer cord should be arranged so that it will not drape over the countertop or tabletop where it can be pulled on by children or tripped over.

*** Attention:**

When used for the first time, white smoke and odor are normal.

Power:	220-240V 50/60HZ 1800W
--------	------------------------

KNOW YOUR AIR FRYER OVEN

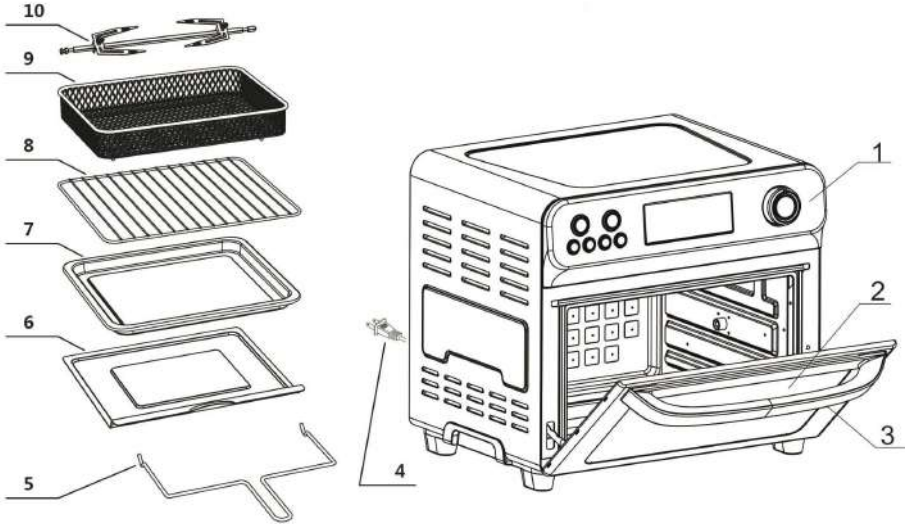

- 1. Key Panel
- 2. Glass Door
- 3. Door Handle
- 4. Power Cord
- 5. Fetch Rack
- 6. Crumb Tray

- 7. Bake Tray
- 8. Oven Rack
- 9. Air Fryer basket
- 10. Rotisserie

Control Panel

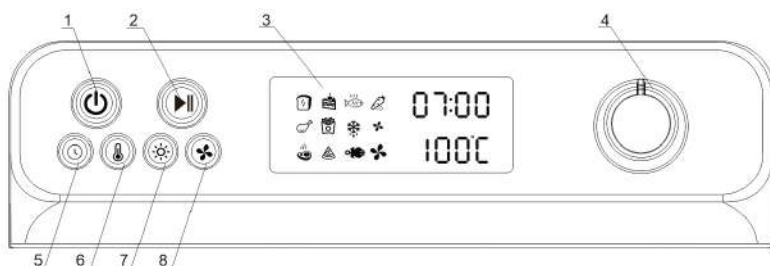

1.Power ON/OFF Button

2. Start/Pause

3.LED display

4.Adjusting knob

5.Time Control Button

6.Temperature Control Button

7.Light Button

8.Fan Speed Button

BEFORE FIRST USE

BEFORE USING FOR THE FIRST TIME

1. Remove all packaging stickers, and labels from the unit.
2. Wash the Fry Basket, Oven Rack, Baking Pan, and Crumb Tray with hot water, some dishwashing liquid, and a non-abrasive sponge. Dry before placing trays into Air Fryer Oven.
3. Place the Crumb Tray in the bottom of the Air Fryer Oven.

CAUTION:

- Do not place the Air Fryer Oven against a wall or against other appliances. It is important to leave at least 4 inches of free space on the back and sides, and 4 inches of free space above the Air Fryer Oven to allow for proper ventilation.
- Do not put anything on top of the Air Fryer Oven.

USING YOUR AIR FRYER OVEN

The Air Fryer Oven preset function is only for the reference, the actual cooking time & temperature can be setted according to the specific food

Product Features

1.The adjusting knob can be rotated clockwise or anticlockwise to quickly switch modes and adjust time and temperature.

2.Highlight LED display, clear operation, real-time display of temperature and remaining time.

3. Fan Speed Button

The oven has two speed fan working: low or high. One fan speed light is on when fan works at low speed, while two fan speed lights on under high fan speed works

4. Power ON/OFF Button

Use to start or stop the oven after set well.

5. Light Button

Press the light button throughout the cooking process to observe cooking if desired. Press the light button again to turn it off. The light will turn off after one minute.

Operating Instructions

1. Power on (power on initialization), standby mode The control panel is plugged into the standby mode: the buzzer will give a beep.The Temperature LED Display shows "OFF".





2.power on

Short press the POWER button to start the machine, and the LED screen will light up.The default mode is bread mode.It is shown as follows:



The bread symbol flashes, all other symbols are on, and the duration, temperature and fan speed (Low speed shows small blade symbol and High speed shows strong wind blade symbol) are shown in the table below. The above process is defined as the boot screen. When the adjusting knob is turned anticlockwise, the flashing icon will move to the left, and when the adjusting knob is turned clockwise, the flashing icon will move to the right. Press start  when mode is selected, and press again to enter the pause process.

During Mode Operation :

1. Temperature display set temperature, time display minutes countdown. Return to the boot screen when returning to zero.
2. Press the fan speed button  to switch the wind speed. The preset program of High wind is not allowed to adjust to Low wind speed.
3. Press the light button  to turn the halogen lamp on or off. After forgetting to turn OFF the halogen lamp for 60s, it will automatically turn OFF.
4. Press the time button  to adjust the duration in the preset program, clockwise rotation +5min, the maximum 60min, counterclockwise rotation -5min, the minimum 5min. Every time you adjust the buzzer drop short tone.
5. After pressing the temperature button , the temperature control temperature in the preset program can be adjusted by clockwise rotation of +5, the maximum is 230, counterclockwise rotation of -5, the minimum is 60. Each adjustment of a buzzer drop short tone; Cake, dry, thaw mode, only allowed in the program set temperature down.











The process of running and pausing after pressing the mode: the time screen flashes and the buzzer drops three times every 1min to remind the user.

Smart Programs

The oven designed several smart programs as bellow chart show. Smart programs control cooking times and temperatures automatically. Select a smart program, with function select knob, display show the time and temperature accordingly, the icon will be light on. Press start button, oven work according selected smart program.

When intelligent function, the power light is White breath flash;

When Toast function, the light will be Blue breath flash;

Function	Default Temp/Time	Adjusted Temperature /Time Range	Default Fan Speed	Adjustable Fan Speed	Synchronous Motor
 Toast	230 /5min	60-230 /5-60min	High	NO	OFF
 Bake	140 /40min	60-140 /5-60min	Low	YES	OFF
 Fish	230 /25min	60-230 /5-60min	High	NO	ON
 Dehydrate	70 /240min	60-70 /5-900min	High	NO	OFF
 Grill/Broil	230 /20min	60-230 /5-60min	High	NO	OFF
 Air Fry	190 /20min	60-230 /5-60min	High	NO	ON
 Unfreeze	60 /30min	40-70 /5-60min	Low	YES	OFF
 Steak	230 /12min	60-230 /5-60min	High	NO	OFF
 Pizza	230 /7min	60-230 /5-60min	High	NO	OFF
 Rotisserie	180 /45min	60-230 /5-60min	High	NO	ON

CONVECTION TIPS

TIPS ON USING THE CONVECTION SETTING

Because convection cooks foods faster and is hotter, you can reduce the cooking temperature by 25°, and check for doneness three quarters of the way through the cook time.

Foods that are covered benefit from the convection's even heat and will cook faster without any moisture loss.

The high temperature air circulation produces roasted foods that are golden brown on the outside and juicy and tender on the inside.

Even cooking means that you can use more than one rack and you do not have to turn foods or rotate baking trays.

Below are foods that benefit from the convection setting and when to use it:

Convection roast:

Meat, vegetables, whole fish

Convection Bake:

Pies, pastries, cookies, biscuits

Convection Broil:

Meat, fish, for melting cheese, for browning the top of casseroles

Pizza:

- Use the lower rack position and check often so the cheese does not burn.
- Start with no convection and then turn on convection for the last few minutes to brown cheese.

Additional tips:

- Make sure air can circulate around food and pans.
- Use trays, roasting pans, and baking pans with lower sides.

TROUBLESHOOTING

Problem	Solution
The Air Fryer Oven does not work	Ensure the unit is plugged into a dedicated power outlet.
Food is not cooked	Use smaller batches for more even cooking
	Raise temperature and continue cooking
Food is not fried evenly	Turn over food halfway through cooking process
	Cook similar sized foods together
White smoke is coming out of the Air Fryer Oven	Clean the Air Fryer Oven and accessories after each use to remove greasy residue
French Fries are not cooking evenly	Fry less potatoes at a time
	Blanch potatoes before frying
	Use firm, fresh potatoes cut into sticks
Fries are not crispy	Remove excess water from potatoes
	Cut potatoes into more narrow strips
	Mist with a little more oil

CLEANING & MAINTENANCE

WARNING: Never immerse cord, plugs, or appliance in water or other liquid. Do not plug in the appliance or operate the control panel with wet hands.

- Clean the appliance after every use.
- Always unplug the appliance and let it cool down completely before cleaning.
- Never clean with abrasives or caustic products appliance.
- Dishwasher clean accessories, or hand wash with nylon Score pad or brush in warm soapy water.
- Before first use, wash all accessories in hot water, detergent and a non-abrasive sponge, then wipe the interior and exterior
Wipe the air fryer with a damp cloth.
- Always place the crumb tray on the bottom of the cooking
Collects oil from fried food and cleans easily.
- For easier cleanup, it is recommended to line the baking sheet with crumbs Tray with aluminum foil.
- For a deep clean, soak accessories in warm soapy water overnight
And scrub with a non-abrasive brush or sponge.
- For cleaning the inside and outside of the oven, it is recommended to use an oven cleaner and wipe with a damp cloth or non-abrasive sponge.

STORAGE

- Unplug the appliance and let it cool down.
- Make sure all parts are clean and dry.
- Store the appliance in a clean and dry place.

ENVIRONMENT

Do not throw away the appliance with the normal household waste at the end of its life, but hand it in at an official collection point for recycling. By doing this, you help to preserve the environment.

HOW TO SET

1. To start the oven, hard press turn on the switch. ⏻
2. To turn off the oven, hard press the switch three seconds. ⏻

FREE SETTING

Adjust freely according to your needs



FREE SELECTION MODE 1

- Step 1:** Plug in the power supply and turn on the use switch.
- Step 2:** Select the toaster (first icon on the LED screen).
- Step 3:** Press the time button then set up the cooking time via turning the knob.
- Step 4:** Press the temperature button, then set up the cooking temperature via turning the knob.
- Step 5:** Press the start button.

HOW TO SET FREE SETTING



FREE SELECTION MODE 2

Step 1: Plug in the power supply and turn on the use switch.

Step 2: Select the bake. (second icon on the LED screen)

Step 3: Press the time button then set up the cooking time via turning the knob.

Step 4: Press the temperature button then set up the cooking temperature via turning the knob.

Step 5: Press the fan button you can choose the high/low speed fan. (mainly for bake function)

Step 6: Press the start button.

HOW TO SET

PRESET MODE

Settings to quickly cook your favorite meals



Step 1: Plug in the power supply and turn on the use switch.

Step 2: Turn the knob to select the cooking mode via the LED screen. (toast/cake/fish/dehydration/chicken/ chips/warm/steak/ pizza/Rotisserie)

Step 3: Press the start button.

Note:

Please close the glass door after pressing the power button.

Instructions for use included in the package.

During operation, do not directly touch the outside of the oven with your hands.

Please wash in time after use.

ACCESSORIES INSTRUCTIONS

COMPLIMENTARY ACCESSORIES

Crumb Tray



32.6×29.8cm

Function:

Intercepts grease and crumbs that fall out during food cooking.

Installation Method:

Place the Crumb Tray under the bottom heating tube as shown in the picture.

Cooking advise:

No food contact

Position: 4



Bake Tray



32.8×28.5cm

Function:

Pans have depth to better hold food and receive hot air from the top.

Installation Method:

Place the Bake Tray on level 1. 2.3

Cooking advise:

Pie/Cake/Pizza/
Whole Chicken

Position: 1 2 3



Oven Cavity Diagram



ACCESSORIES INSTRUCTIONS

COMPLIMENTARY ACCESSORIES

Oven Rack



32.8×27.7cm

Function:

Use an Oven Rack to allow hot air to heat food evenly from the top fan and bottom heat pipes.

Installation Method:

Place the Oven Rack on level 1.2.3

Cooking advise:

Steak/Chicken/Fish/Toast/
Potato/Sausage

Position: 1 2 3



Air Fryer Basket



33.3×27×3cm

Function:

Air Fryer Basket can hold more small and large quantities of food.

Installation Method:

Place the Air Fryer Basket on level 1.2.3

Cooking advise:

Fries/Chicken Nuggets/
Potato Wedges/Doritos

Position: 1 2 3



Oven Cavity Diagram



ACCESSORIES INSTRUCTIONS

COMPLIMENTARY ACCESSORIES

Fetch Rack



27.6×14cm

Function:

Use Fetch Rack to install and remove the rotisserie rack.

Installation Method:

1. When installing, align both ends of the same letter, first align the B end, and then install the A end.
2. When taking out, lift end A first, and pull out end B outwards.

Cooking advise:

No food contact

Gloves



Function:

Use Gloves to remove all accessories after cooking to prevent burns.

Installation Method:

Wear gloves and move hot accessories.

Cooking advise:

No food contact



Oven Cavity Diagram



ACCESSORIES INSTRUCTIONS

COMPLIMENTARY ACCESSORIES

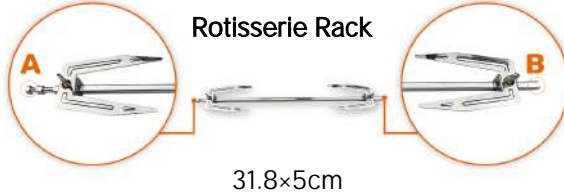

Function:

Rotisserie Rack can fix larger food and the synchronous motor in the oven makes the food rotate 360 degrees in the oven to achieve the best cooking effect.

Installation Method:

1. Pass the shaft through the fork, adjusting the distance of the fork according to the size of the food.
2. Pass the screw through the hole above the fork and tighten to secure the fork.
3. When installing, align the two ends of the same letter, first align the B end, and then install the A end.

Cooking advise:

Whole Chicken/Pork Knuckle

Position: 5



Oven Cavity Diagram

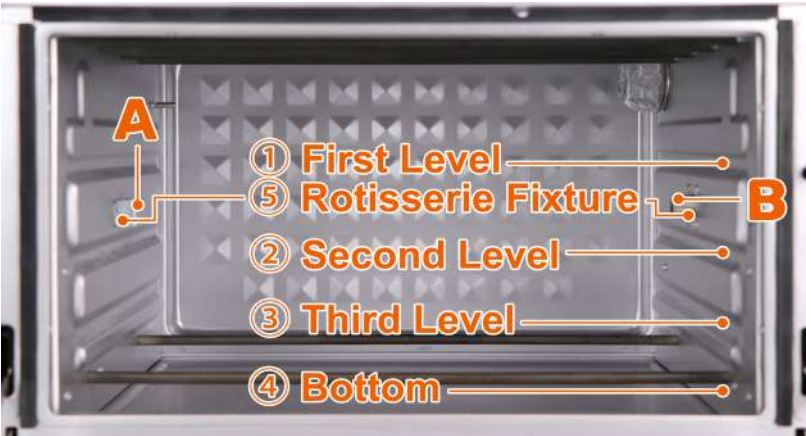

ACCESSORIES INSTRUCTIONS

OPTIONAL ACCESSORIES

Panini Maker Mold



25.5×16.5cm

Cooking advise:
Panini/Sandwich

Kebab Rotary Rack



18×14cm

Cooking advise:
Chicken Kebabs
/Mutton Kebabs

Rolling Grill Basket



18×12×12cm

Cooking advise:
Fries/Chicken Nuggets

Air Fryer Basket



30.3×24.6×4.4cm

Cooking advise:
Fries/Chicken Nuggets

Pizza Baking Sieve



d:25.5cm

Cooking advise:
Pizza

Kitchen Tongs



26.9×3.8cm

ACCESSORIES INSTRUCTIONS

WARNING&TIPS

1. Optional accessories need to be purchased separately.
2. Be careful not to reverse the ends of the Rotisserie, otherwise it will cause motor failure.
3. The Crumb Tray must be placed in the designated position - under the bottom heating tube.
4. All accessories are dishwasher safe.(except gloves)
5. Please refrain from touching the items with your hands until they have cooled.
6. Place a foil-wrapped tray under the grill to reduce cooking fumes.
7. Please put the chicken rack out of the reach of children to avoid accidentally swallowing the screws.
8. Please do not heat the gloves in the oven.
9. Some special foods may cause the accessories to be stained after heating, but the accessories themselves will not fade.
10. When cooking with multiple accessories at the same time place the tray on the bottom (third level) to avoid blocking the hot air from the top.

ACCESSORIES COMBINATION

COMPLIMENTARY ACCESSORIES



Combination 1
Oven Rack
Bake Tray

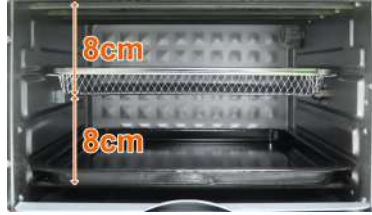

Combination 2
Air Fryer Basket
Bake Tray



Combination 3
Air Fryer Basket
Oven Rack



Combination 4
Air Fryer Basket
Oven Rack Bake Tray



Combination 5
Rotisserie Rack

ACCESSORIES COMBINATION

OPTIONAL ACCESSORIES



Combination 1
Three Oven Racks

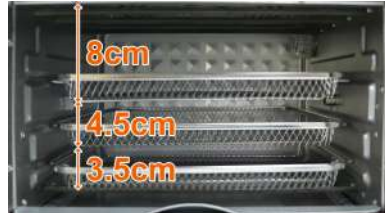

Combination 2
Three Air Fryer Baskets

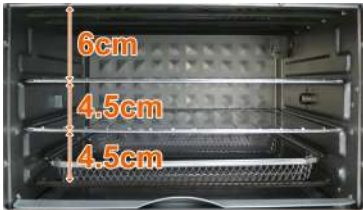

Combination 3
Two Oven Racks
Air Fryer Basket

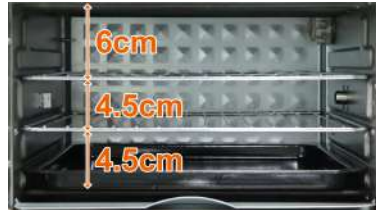

Combination 4
Two Oven Racks
Bake Tray



Combination 5
Rolling Grill Basket

ABOUT HYSAPIENTIA AIR FRYER OVEN

How HYSapientia Air Fryer Oven works?

HYSapientia Air Fryer Oven is combined with both normal oven and air fryer function. It has upper and lower heating tubes + high-speed fan structure, when the fan and heating tube operating together, it is equivalent to having functions such as air frying, fast grilling/ baking/ roasting/dehydration etc...

How HYSapientia Air Fryer Oven differentiates from the Normal Convection Oven?



1. HYSapientia Air Fryer Oven has high speed fan with the speed between 2000rpm. But Normal Convection Oven has low speed fan with the speed only about 1000rpm.
2. HYSapientia Air Fryer Oven has the special air duct which can absorb the air from two sides of the oven and generate 360°thermal cyclone on the top of oven, then powerful hot wind causes the air fryer effect.

How HYSapientia Air Fryer Oven differentiates from the Normal Air Fryer?

1. HYSapientia Air Fryer Oven is made of the stainless steel, but most Air Fryer is made of the plastic.
2. HYSapientia Air Fryer Oven has large capacity compare with most Air Fryer Oven.

FREQUENTLY ASKED QUESTIONS

Q1: Why can't I adjust the fan speed?

A1: The fan cannot be switched off, it can only be adjusted in bake  or unfreeze  mode to adjust the speed of the fan.

Q2: How can I switch the air fryer oven to the oven function?

A2: You can select the Bake(cake) mode, which is an oven function with temperature range of 60-140 degrees and time of 5-60 minutes. Also adjustable for high and low speed fan.

Q3: What if my food is not cooked or over cooked when it's in preset mode?

A3: If the food is not cooked or over cooked in the certain preset mode, so for next cooking you can slight adjust the temperature and time in this mode, as the preset mode just for the reference.

Q4: Does the Air Fryer Oven have the microwave function?

A4: The air fryer oven does not have microwave function, if you want to heat up the food, you can wrap it with aluminum foil and set the temperature around 100°C.

Q5: What if the Air Fryer Oven fill with oily smoke when cooking?

A5: There is not just the heat tube on the top but also at the bottom of air fryer oven, also the oven inner temperature could reach over 200°C when operation. So if you cook the meat with rich fat, such as pork or lamb, the fat burns become the oil and drip on the heat tube could cause the smoke, because the smoke point of meat fat is around 230°C, so we strongly recommended to place the bake tray cover with aluminum foil on the lower level in the oven in order to intercepts grease that fall out. alternatively, you can lower the cooking temperature under 200°C.

Q6: Why does the fan keep operating when the oven stop working?

A6: When the oven stopped and the temperature is above 80°C, the oven heater will turn off and the fan will continue to run for a minute to help dissipate the hot air inside and cool down the oven.

Q7: Why does moisture appear above the oven door frame?

A7: When cooking food with high water content, such as frozen food with ice shards, the water vaporizes into water vapor due to temperature rise. When the temperature is lowered, the water vapor on the surface will liquefy into water droplets, which is a normal phenomenon.



easy cooking&healthy eating



Web:www.hysapientia.com

E-mail:service@hysapientia.com