

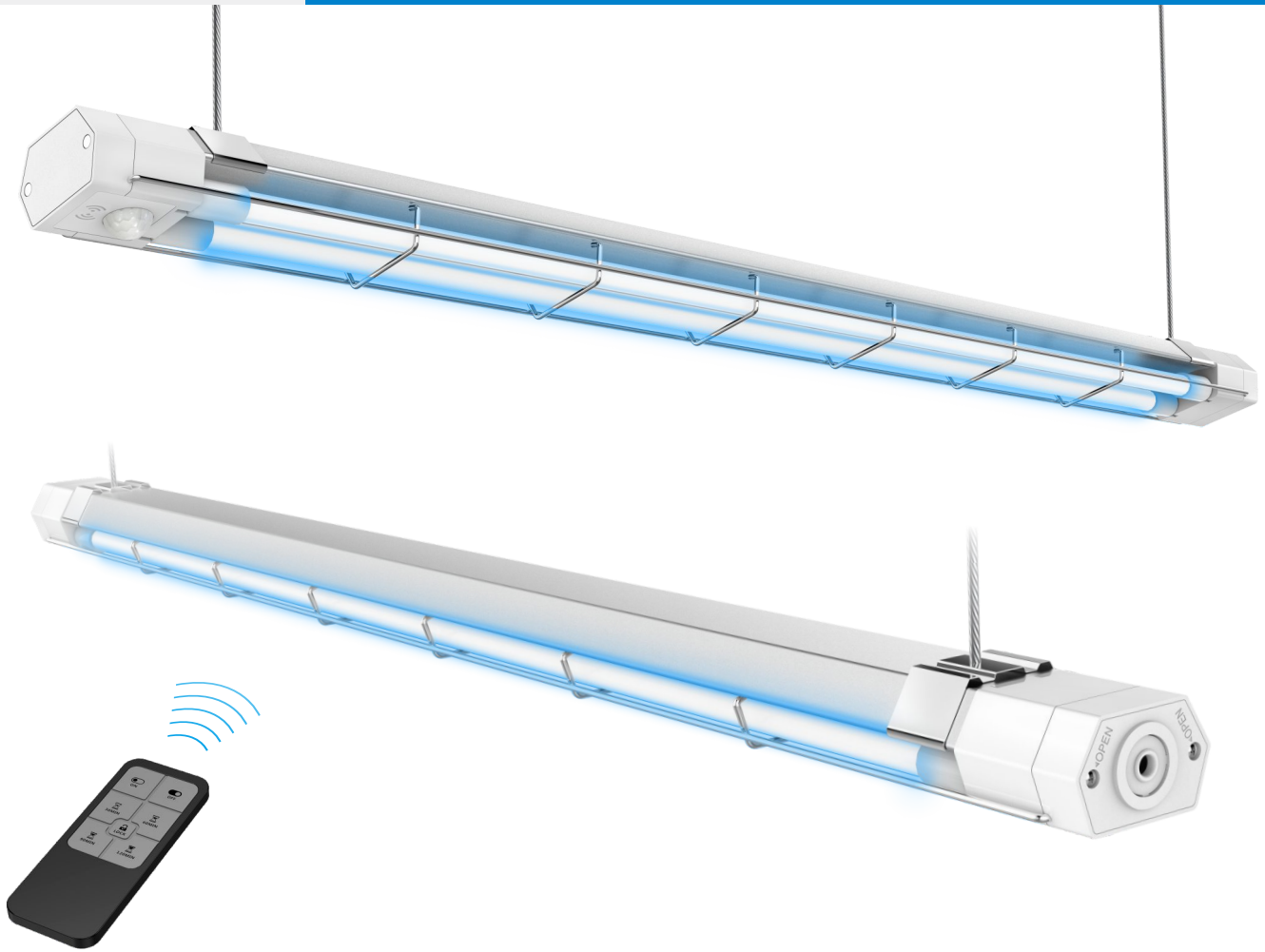

U12-01/02 | UVC TUBE LIGHT

40W / 60W / 80W



Specifications

Model No.	Power	Voltage	Wave length	Lamp type	Lamp base	Hold time	Lamp size	Operating Temp (°C/°F)	Life span	Weight (lbs=kgx2.2)	Color
U12-40W-01	40W±15%	100-120V 50-60Hz	254nm	UVC	G5	30/60/90/ 120mins/stay	704 x 67 x 54mm	-10~35°C 14~95°F	9,000H	NW:0.96kg GW:1.30kg	Matt Silver
U12-60W-01	60W±15%	100-120V 50-60Hz	254nm	UVC	G5	30/60/90/ 120mins/stay	1009 x 67 x 54mm	-10~35°C 14~95°F	9,000H	NW:1.24kg GW:1.77kg	Matt Silver
U12-80W-01	80W±15%	100-120V 50-60Hz	254nm	UVC	G5	30/60/90/ 120mins/stay	1313 x 67 x 54mm	-10~35°C 14~95°F	9,000H	NW:1.53kg GW:2.15kg	Matt Silver
U12-40W-02	40W±15%	220-240V 50-60Hz	254nm	UVC	G5	30/60/90/ 120mins/stay	704 x 67 x 54mm	-10~35°C 14~95°F	9,000H	NW:0.96kg GW:1.30kg	Matt Silver
U12-60W-02	60W±15%	220-240V 50-60Hz	254nm	UVC	G5	30/60/90/ 120mins/stay	1009 x 67 x 54mm	-10~35°C 14~95°F	9,000H	NW:1.24kg GW:1.77kg	Matt Silver
U12-80W-02	80W±15%	220-240V 50-60Hz	254nm	UVC	G5	30/60/90/ 120mins/stay	1313 x 67 x 54mm	-10~35°C 14~95°F	9,000H	NW:1.53kg GW:2.15kg	Matt Silver

Feature

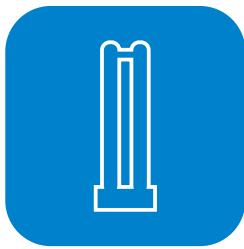

Quartz tube

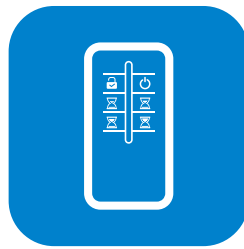

Wireless remote



18S delay start-up



Ozone-free UV



Microwave and PIR Sensor Built-in

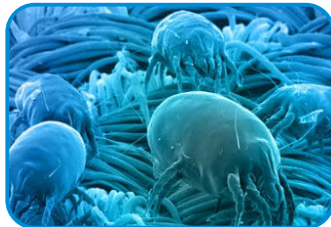

Effectively kill 99.99% mites



effective killing of parasites 99.9%

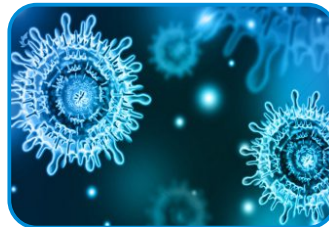

effective killing of virus 99.9%



UV irradiation

Ozone-free UV lamp

Ultraviolet light rays travel in a straight line, they do not disinfect a surface if it is blocked from the direct light

Sensor Built-in

Ceiling Mount
Top View

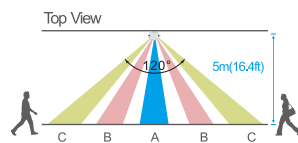
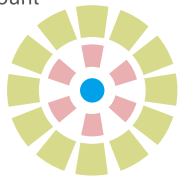

Wall Mount
Top View

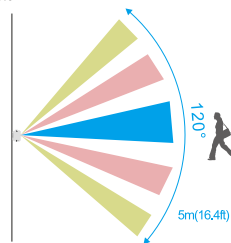

Top View

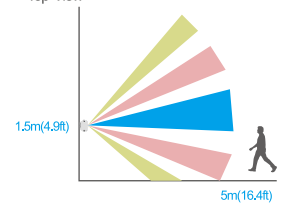

Feature

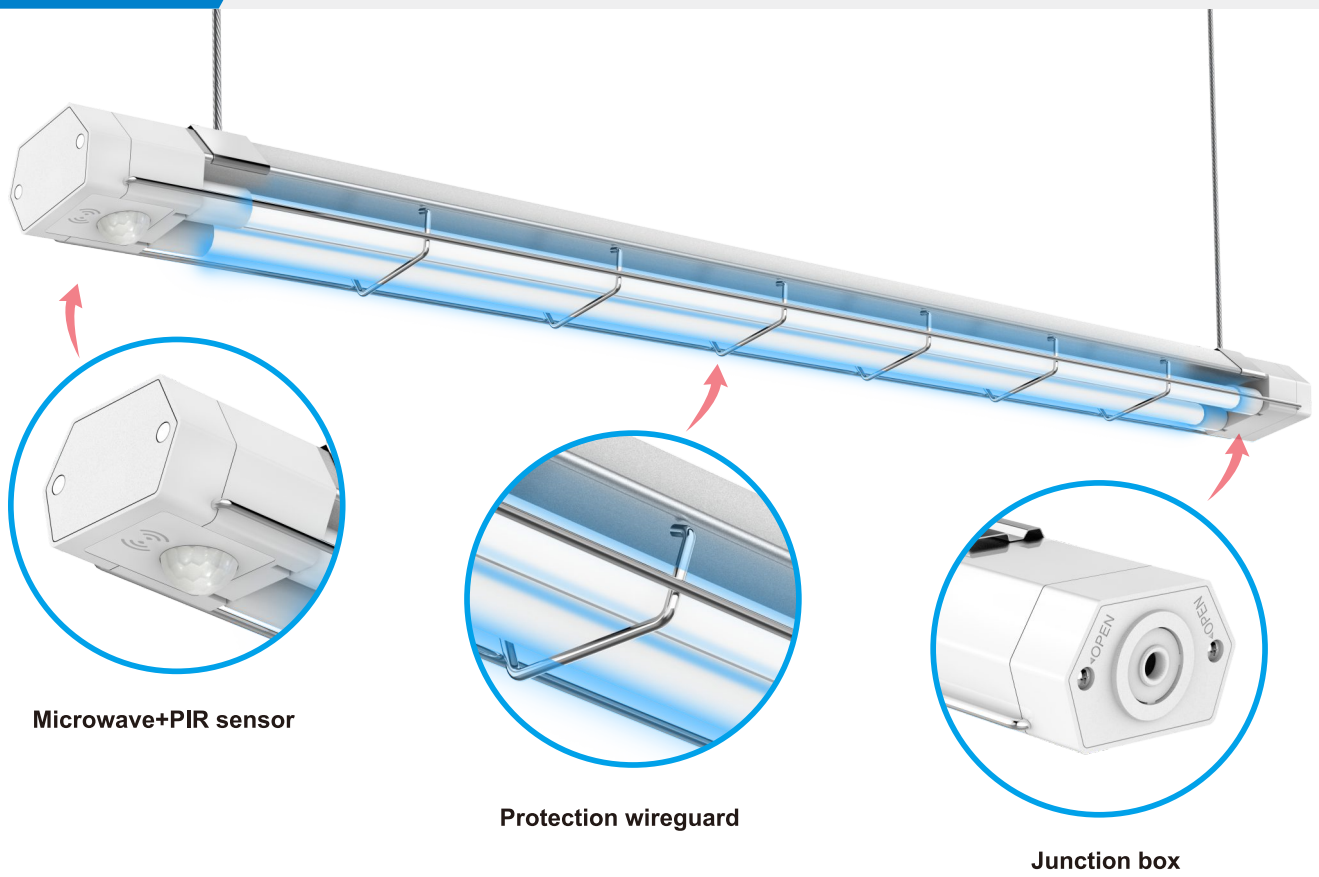

Microwave+PIR sensor

Protection wireguard

Junction box

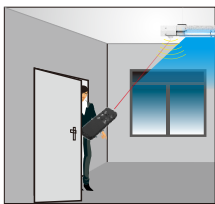

1

Wireless remote, let you operate at a far distance, ensuring UVC light beaming never touch your

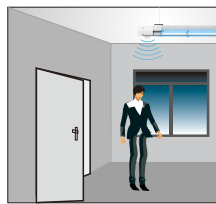

2

Built-in microwave+PIR
A. Once the human approaching the lamp, it will turn off automatically
B. Double security: Should both of the sensors dead, the lamp will never turn on, so as to ensure the human safety

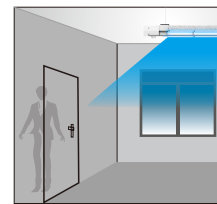

3

Built-in microwave and PIR
After detecting the human have left, the UVC lamp will turn on automatically, and back to the target work

Dimensions

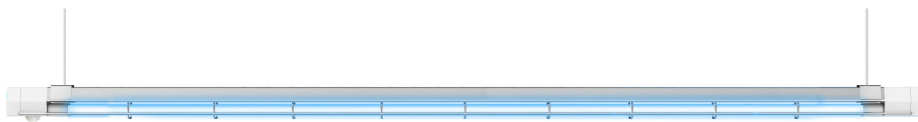

2X40W 4FT
Size: L1313*W67*D54 mm

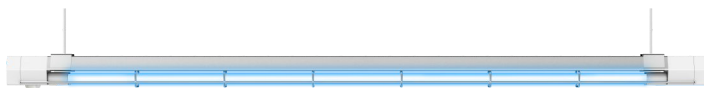

2X30W 3FT
Size: L1009*W67*D54 mm



2X20W 2FT
Size: L704*W67*D54 mm

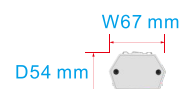

Application



U12 Installation

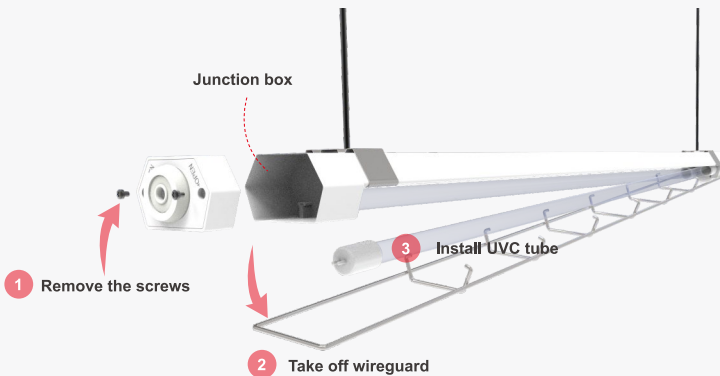

Different mounting installation

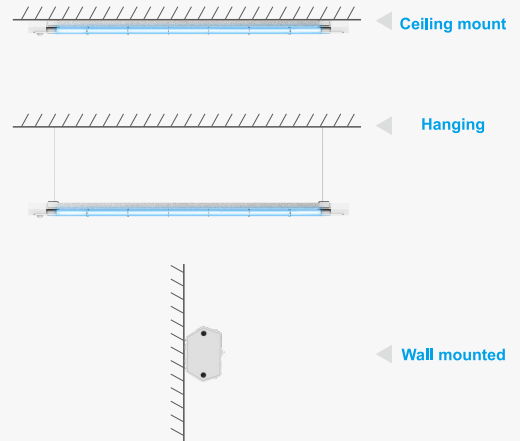

Packing

Model No.	Inner box size (mm) (x0.0393=inch)	N.W per lamp (kg) (lbs=kgx2.2)	G.W per lamp (kg) (lbs=kgx2.2)	G.W per Carton (kg) (lbs=kgx2.2)	Carton size (mm) (x0.0393=inch)	Quantity per carton
U12-40W	Light fixture: 730x80x64mm UVC tube: 730x80x38mm	Light fixture: 0.882 1 UVC tube: 0.073	Light fixture: 1.035 UVC tube: 0.265	8.35	745x320x175mm	6PCS
U12-60W	Light fixture: 1035x80x64mm UVC tube: 1035x80x38mm	Light fixture: 1.134 1 UVC tube: 0.104	Light fixture: 1.350 UVC tube: 0.420			
U12-80W	Light fixture: 1340x80x64mm UVC tube: 1340x80x38mm	Light fixture: 1.400 1 UVC tube: 0.132	Light fixture: 1.670 UVC tube: 0.480	14.17	1355x320x175mm	6PCS

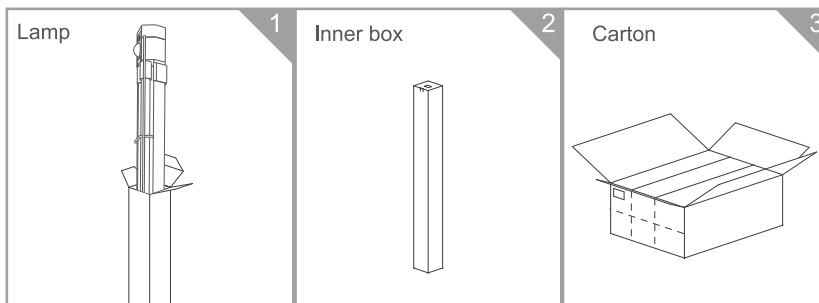

CAUTIONS

- Risk of electric shock. Do not use where directly exposed to water.
- Avoid UV light direct eyes and skin when turn on the lamp.
- Don't take apart the lamps without our permit.

GK SHENZHEN GUANKE TECHNOLOGIES CO., LTD

Bldg 34, XiaLang Industrial Zone, HeShuiKou Community, MaTian St., GuangMing Dist., ShenZhen 518106, China

Tel: +86-755-27165559
E-mail: info@szguanke.com

Fax: +86-755-27543939
Web: www.gkuvc.com