

JHA0020DA 90° DATASHEET

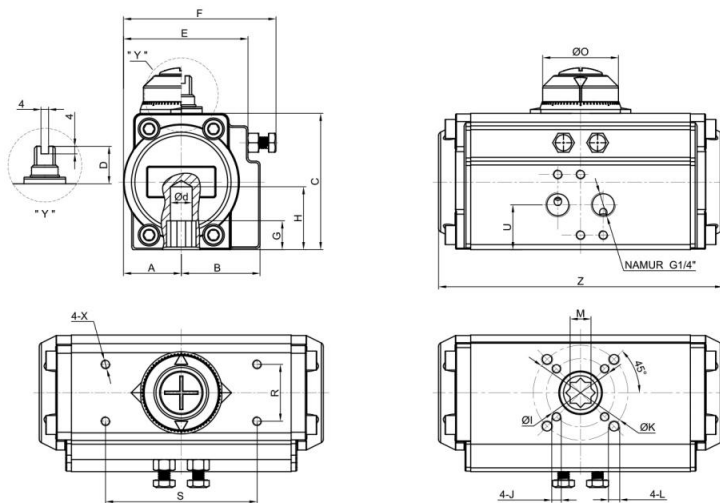

Reference Parameters		
Cylinder size	52	mm
Weight	1.3	kg
Air volume	Open	0.12
	Close	0.17
Cycle speed*①	Open	<1
	Close	<1
Pressure rang	2 up to 8	bar(g)
Media	Clean, dry and non-corrosive compressed air	
Temperature	High	-15 up to 150
	Standard	-20 up to 80
	Low	-40 up to 80
Flange	F03&F05	
Stroke	90±5	°

> According to EN 15714-3 & ISO 5211

>*①. Test conditions: clean air with a pressure of 6 bar, the diameter of the pipe is 8 mm, and the temperature is room temperature.

Dimensions in mm																					
Model	A	B	C	D	E	F	G	H	φI	J	φK	L	M	R	S	X	O	U	φd	Z	Air connection
JHA0020DA	31	42	72	20	66	81	15	33	36	M5*8	50	M6*10	11	30	80	M5*8	40	24	12	150	G1/4"

OUTPUT TORQUE (Unit:N.m)

Model	Air Supply Pressure in bar(g)										
	2	2.5	3	3.5	4	4.5	5	5.5	6	7	8
JHA0020DA	8	10	12	14	16	18	20	22	24	28	32

OUTPUT TORQUE (Unit:lbf.in)

Model	Air Supply Pressure in psi										
	29	36	44	51	58	65	73	80	87	102	116
JHA0020DA	71	89	106	124	142	159	177	195	212	248	283

Notes:

- > 1 bar(g) = 14.5038 psi ; 1 N.m = 8.8507 lbf.in
- > For further information regarding options , materials , certifications and additional execution please contact JUHANG's sales office.
- > Flange and bi-square drive shall comply with ISO 5211 standard.
- > Solenoid valve mounting interface according to VDI/VDE 3845(NAMUR)

