

感触科技 / 启动未来!

遥控器、按钮、信号灯专业供应商



Contents

目录



工业用遥控器系列
Remote controller for industrial

01~07



按钮控制盒系列
Pushbutton Control box series

46~51



YB2按钮系列
YB2 Pushbutton series

08~29



吊机控制站系列
Pendant control stations series

52~61



YB4按钮系列
YB4 Pushbutton series

30~34



YHLA1\TA42\LA38
按钮系列
YHLA1\TA42\LA38
Pushbutton series

62~74



YB5按钮系列
YB5 Pushbutton series

35~40



YHJ 金属按钮系列
YHJ Metal switch series

75~80



AD6系列指示灯
AD6 Indicator lamp series

41~45



LAY90-V16按钮系列
LAY90-V16 Push button Series

81~89

F21 系列超轻工业用遥控器
F21 Remote controller for industrial use

产品特点

- 广泛适用于各种工业设备;
- 防水等级达IP65;
- 玻璃纤维外壳结构, 坚固耐用;
- 超宽操作温度范围-35°C~+80°C;
- 低功耗设计, 2个1.5V5号电池;
- 结合汉明码, 自我检测及不重复的32位元识别码;
- 操作距离依机种不同可达50-100公尺。

F21-4S

4个单速按键, 1个紧急开关, 1个开机按键
尺寸: 156X61X51mm

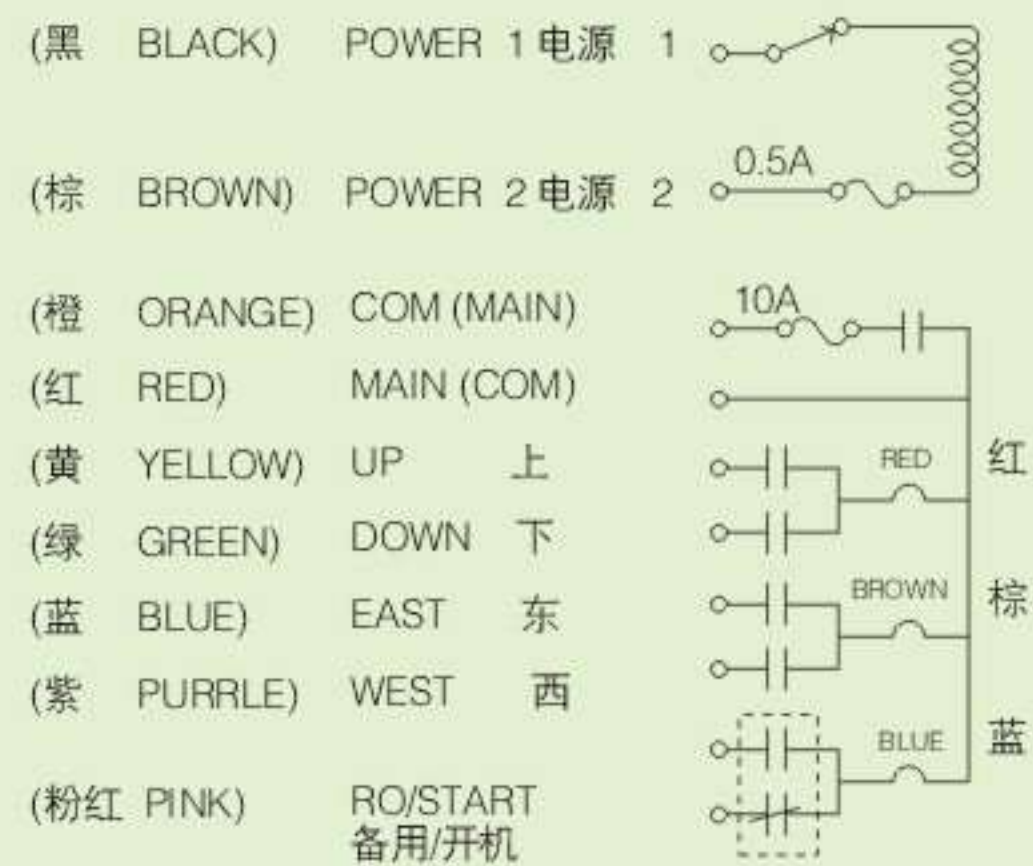

F21-4D

4个双速按键, 1个紧急开关, 1个开机按键
尺寸: 156X61X51mm

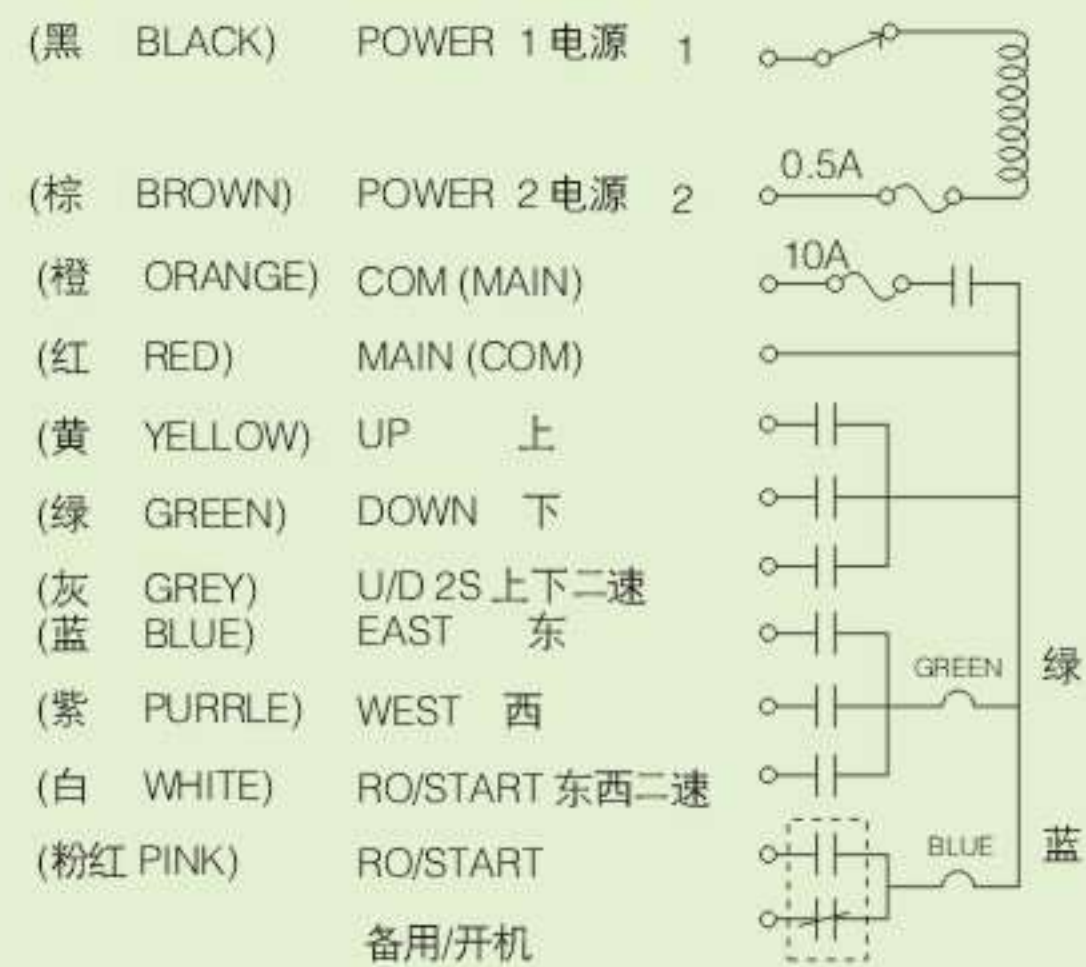

F21 系列超轻工业用遥控器
F21 Remote controller for industrial use

F21-E1B

6个单速按键, 1个紧急开关, 1个开机按键
尺寸: mm



F21-2S

2个单速按键, 1个开机按键
尺寸: 130X45X22mm

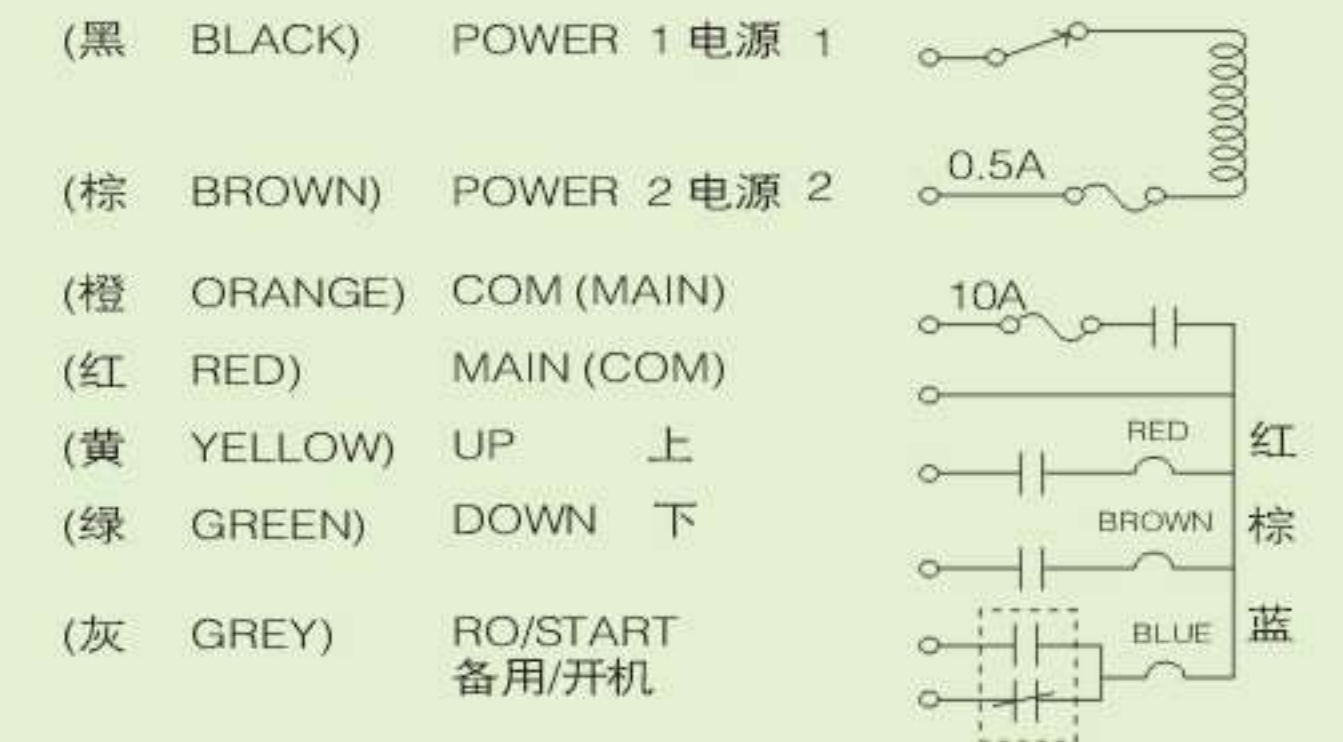

F21-E1

6个单速按键, 1个紧急开关, 1个开机按键
适用于单钩单速行车使用



F23工业用无线电遥控器 F23 Remote controller for industrial use

产品特点

- 弹性化设计；可自行DIY组装； IP65防水、防尘等级；
- 操作功能均可通过F23软体设定； 超宽操作温度范围-35°C~+80°C。
- 发射及接收机构为内藏式天线 (接收机可另行加装附件：被动天线)
- 多重安全保护设计的汉明码及32位元不重复识别码；

F23-BB

10个单速按键，1个紧急开关，1个开机按键
尺寸：218X60X60mm 适用于MD葫芦



F23-A+ +

8个单速按键，1个紧急开关，1个开机按键
尺寸：218X60X60mm 适用于MD葫芦

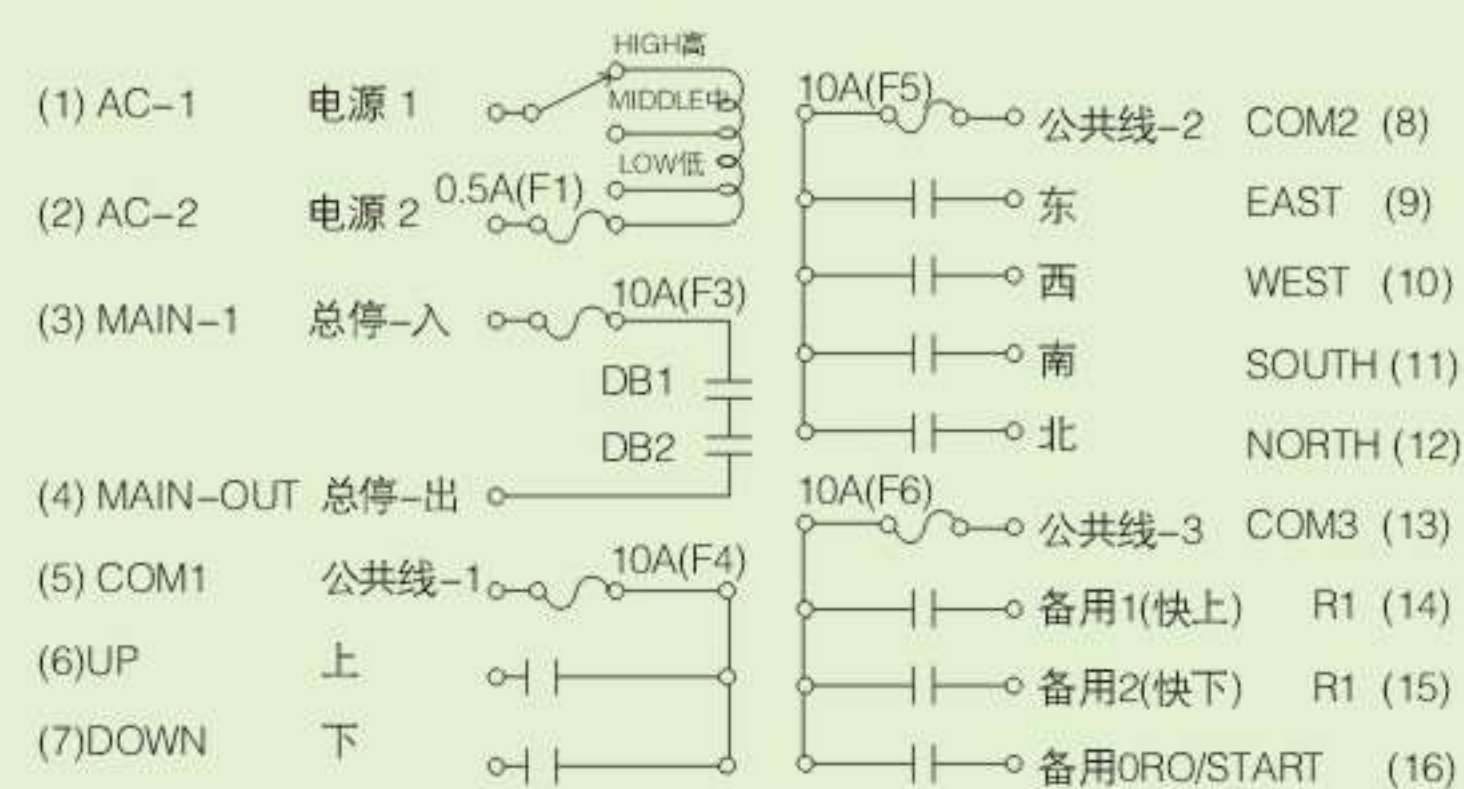

F23工业用无线电遥控器 F23 Remote controller for industrial use

F23-A+

6个单速按键，其中上下为双速、1个紧急开关，1个开机按键，适用于MD葫芦
尺寸：218X60X60mm 重量：350~365克

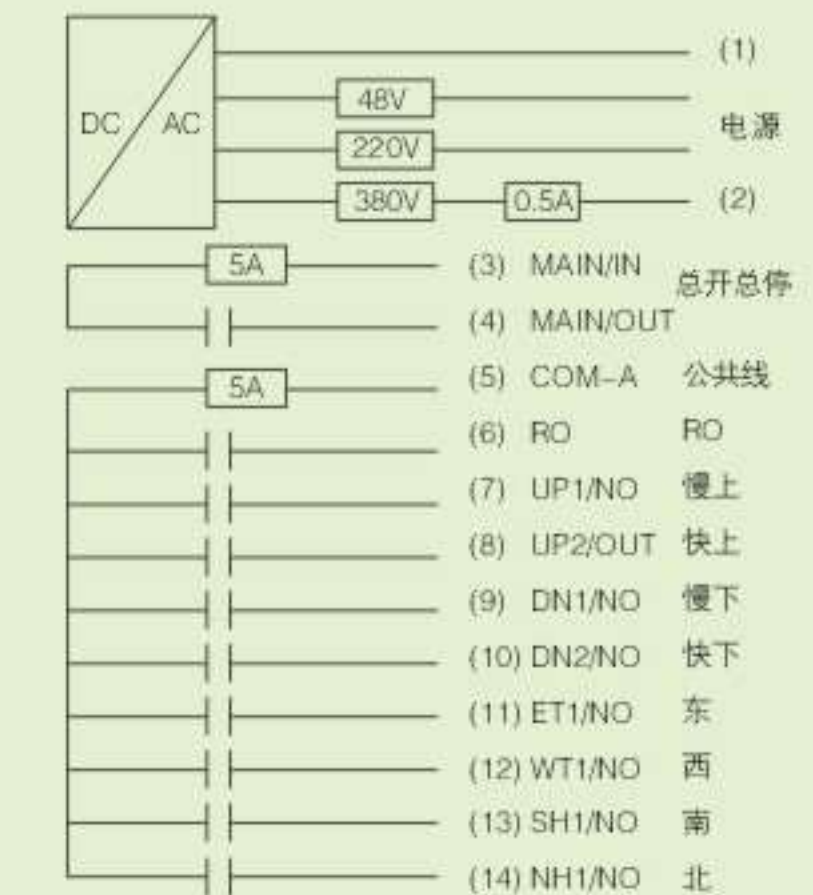

F23-D

10个双速按键，1个紧急开关，1个开机按键
尺寸：218X60X60mm 重量：350~365
适用于单/多速行车使用



F23-C

6个双速按键，1个紧急开关，1个开机按键
尺寸：218X60X60mm 重量：350~365
适用于单/多速行车使用



BF24 防爆系列/F24工业用无线电遥控器
BF24 Remote controller for industrial use

产品特点

轻巧耐用安全稳定; IP65防水防尘等级;
尼龙加纤的强化塑料外壳,可防止摔落及强力碰撞所造成的损坏;
低功耗(使用两颗5号AA碱性电池,平均使用寿命达2个月);

F24-8S

8个单速按键、1个紧急开关、1个开机键、1个旋转钥匙

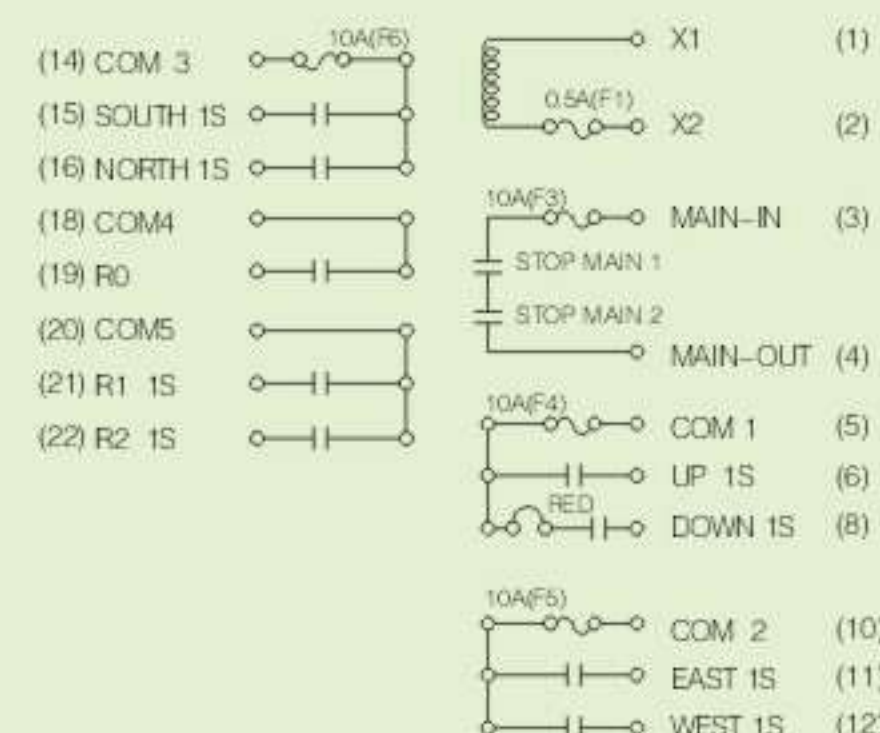

适用单钩单速/多速行车使用

F24-10S

10个单速按键、1个紧急开关、1个开机键、1个旋转钥匙

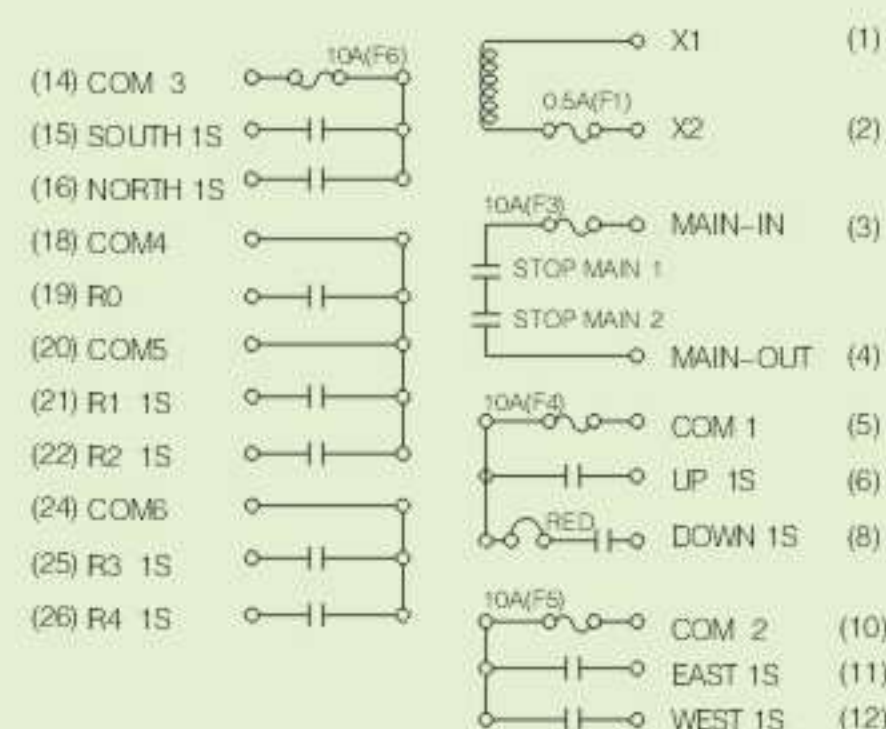

F24-12S

11个单速按键、1个紧急开关、1个开机键、1个旋转钥匙

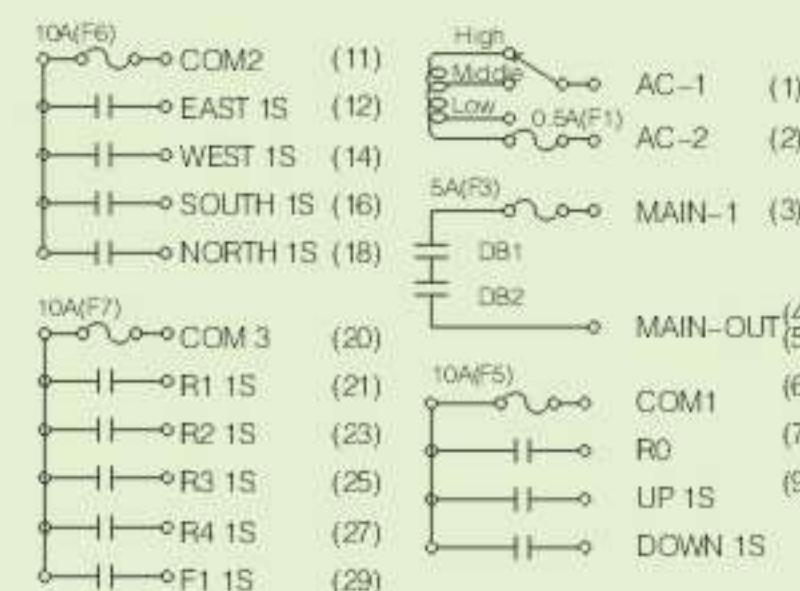

适用于单梁/双梁双钩、
双速/多速行车使用

可经由PC软件设定多种按键功能,能满足各种操作需求;
接收机含输出电缆,安装简单、快速;
多重安全保护设计;汉明码、看门狗线路及32位元不重复识别码。

F24-8D

8个双速按键、1个紧急开关、1个开机键、1个旋转钥匙

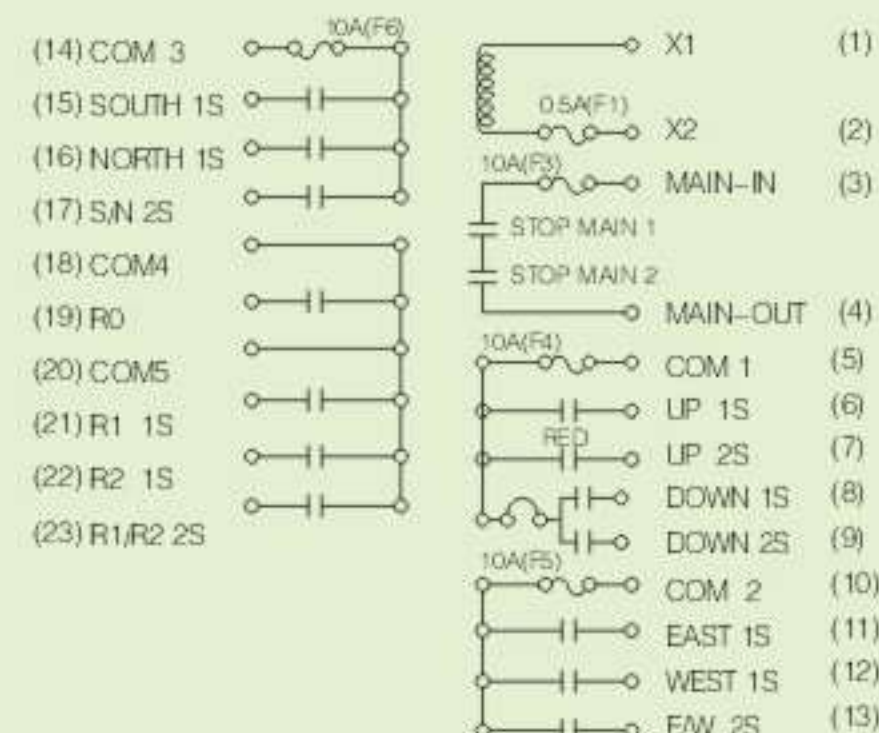

F24-10D

10个双速按键、1个紧急开关、1个开机键、1个旋转钥匙

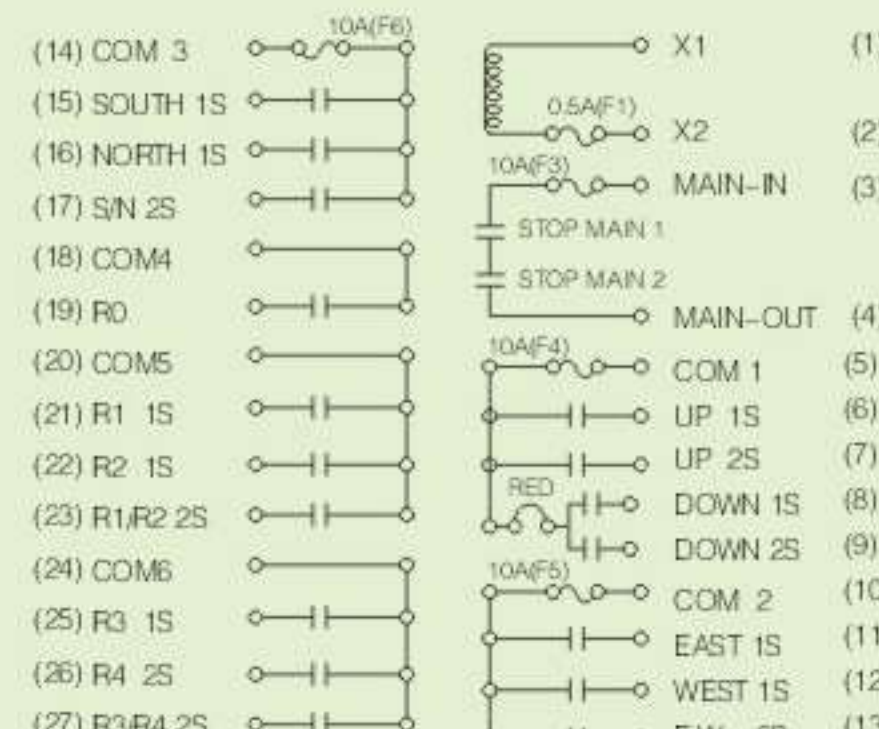

F24-12D

11个双速按键、1个紧急开关、1个开机键、1个旋转钥匙

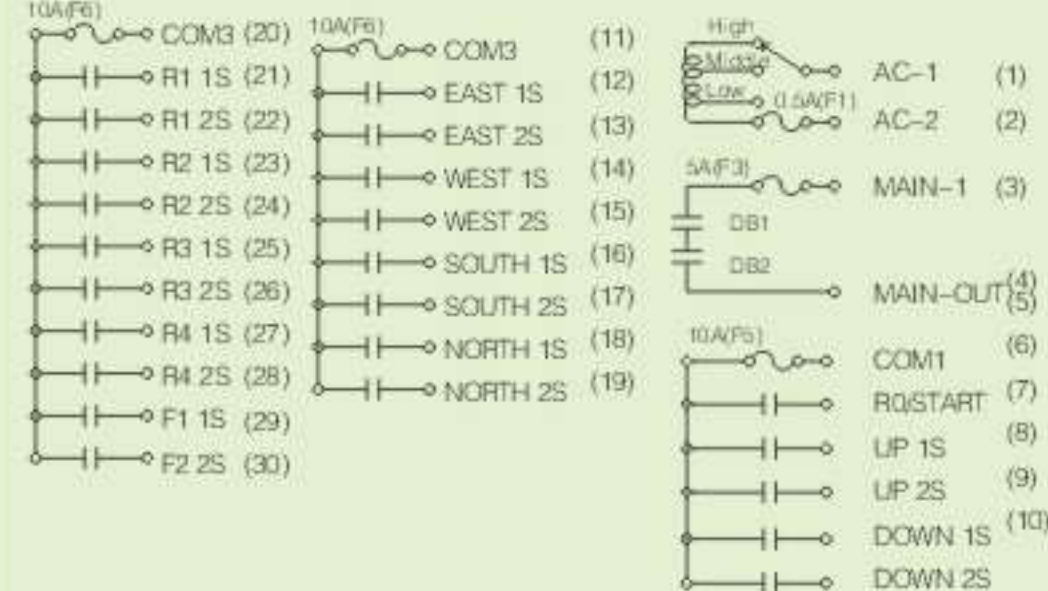

F24-60五速双摇杆工业用无线电遥控器
F24-60Remote controller for industrial use

产品特点

- 轻巧耐用安全稳定;
- 程式化输出设定,经由软件设定单一动作可达16个输出点;
- 操作距离可达100公尺;
- 尼龙加纤的强化塑胶外壳,可防止摔落及强力碰撞所造成的损坏;
- 接收机含输出电缆线,安装简单,快速;发射机三段式电源指示;
- 可规划加速延迟设定(使天车运转更顺畅);
- 多重安全保护设计;汉明码、看门狗线路32位元不重复识别码。



- ☆ 发射机
- 2只五速段落感摇杆
- 6个单速按键(含开机键)
- 1个紧急停止蘑菇头
- 1个旋转钥匙、
- 2个2段式选择开关
- 2个3段式选择开关
- 适用于多钩多速复杂功能
- 超重机械或相应工业控制

Common line	Relay contact	Command	Wire NO	Remark
	F10.5A	AC-1	2-1	
		AC-2	2-2	
	F3 10A	MAIN-IN	2-3	
	DB1 DB2	MAIN-OUT	2-4	
F4 10A		COM1	2-21	
F7 10A		COM2	2-22	
F5 10A		COM3	2-23	
F6 10A		COM4	2-24	
	Ry1	F1	1-1	
	Ry2	R0/START	1-2	
	Ry3	R1	1-3	
	Ry4	R2	1-4	
	Ry5	R3	1-5	
	Ry6	R4	1-6	
	Ry7	SWA	1-7	
	Ry8	SW BA	1-8	
	Ry9	SW BB	1-9	
	Ry10	SW CA	1-10	
	Ry11	SW CB	1-11	
	Ry12	SW D	1-12	
	Ry13	1Y(U)1	1-13	
	Ry14	1Y(D)1	1-14	
	Ry15	1Y(U/D)2	1-15	
	Ry16	1Y(U/D)3	1-16	
	Ry17	1Y(U/D)4	1-17	
	Ry18	1Y(U/D)5	1-18	
	Ry19	1X(L)1	1-19	
	Ry20	1X(R)1	1-20	
	Ry21	1X(L/R)2	1-21	
	Ry22	1X(L/R)3	1-22	
	Ry23	1X(L/R)4	1-23	
	Ry24	1X(L/R)5	1-24	
	Ry25	2Y(U)1	2-25	
	Ry26	2Y(D)1	2-6	
	Ry27	2Y(U/D)2	2-7	
	Ry28	2Y(U/D)3	2-8	
	Ry29	2Y(U/D)4	2-9	
	Ry30	2Y(U/D)5	2-10	
	Ry31	2X(L)1	2-11	
	Ry32	2X(R)1	2-12	
	Ry33	2X(L/R)2	2-13	
	Ry34	2X(L/R)3	2-14	
	Ry35	2X(L/R)4	2-15	
	Ry36	2X(L/R)5	2-16	
	Ry37	(AUX)1	2-17	
	Ry38	(AUX)2	2-18	
	Ry39	(AUX)3	2-19	
	Ry40	(AUX)4	2-20	

SAGA1工业用无线电遥控器

SAGA1 Remote controller for industrial use



SAGA1-K1/K2

8个单双按键含旋转钥匙
急停钮和报警蜂鸣器

SAGA1-K3/K4

12个单双按键, A/B 开关,
含旋转钥匙, 急停钮和报警蜂鸣器

符合欧体4级安规(EN-ISO13849-1 Cat.); 继电器接点侦测; 接收机报警蜂鸣器; 接收机提供输出电缆让您轻松且快速的完成安装;

F型接收机天线方便延伸外接

一般规格

操作频道	70个
识别码	超过100万种组合
频道间隔	25KHz
汉明码长度	>4
外壳	强化加玻璃纤维
工作温度范围	-40°C~+85°C
操作距离	可达100公尺

发射机

电源	“AA” 电池4个	
发射功率	小于10毫瓦	
尺寸(公厘)	163X49X45(SAGA1-K1/K2)	274X77X42(SAGA1-K3/K4)
重量(公克)	约210(SAGA1-K1/K2)	约385(SAGA1-K3/K4)

接收机

电源	24/48/110/220/380VAC(±20%)	
尺寸(公厘)	167X154X88(SAGA1-K1/K2)	310X160X95(SAGA1-K3/K4)
重量(公克)	约2100(SAGA1-K1/K2)含电机	约2900(SAGA1-K3/K4)含电机

特殊功能:

无线遥控配对: 遥控配对可透由无线电方式由接收机将功能设定、识别码及频道等资料以无线电方式传送并下载到发射机上, 以执行配对之工作, 此方式可避免攀爬天车之麻烦, 增加安全性及方便性。

发射机功率: 发射机可依使用者需要调整发射输出功率, 共八段可供设定。

手动换频: 发射机以无线电方式遥控接收机执行换频工作, 接收机接到换频指令后, 即会自动搜寻一个最适合的操作频率, 同时将此操作频率送回至发射机并更新发射机之操作频率。

选购配件:



● 软件与USB烧录线

● 被动天线

● SAGA1-K 拷贝机

● SAGA1-K 保护套

● 12~24V DC/DC转换机

YB2/XB2/LAY5按钮系列 YB2/XB2/LAY5 PUSHBUTTON SERIES

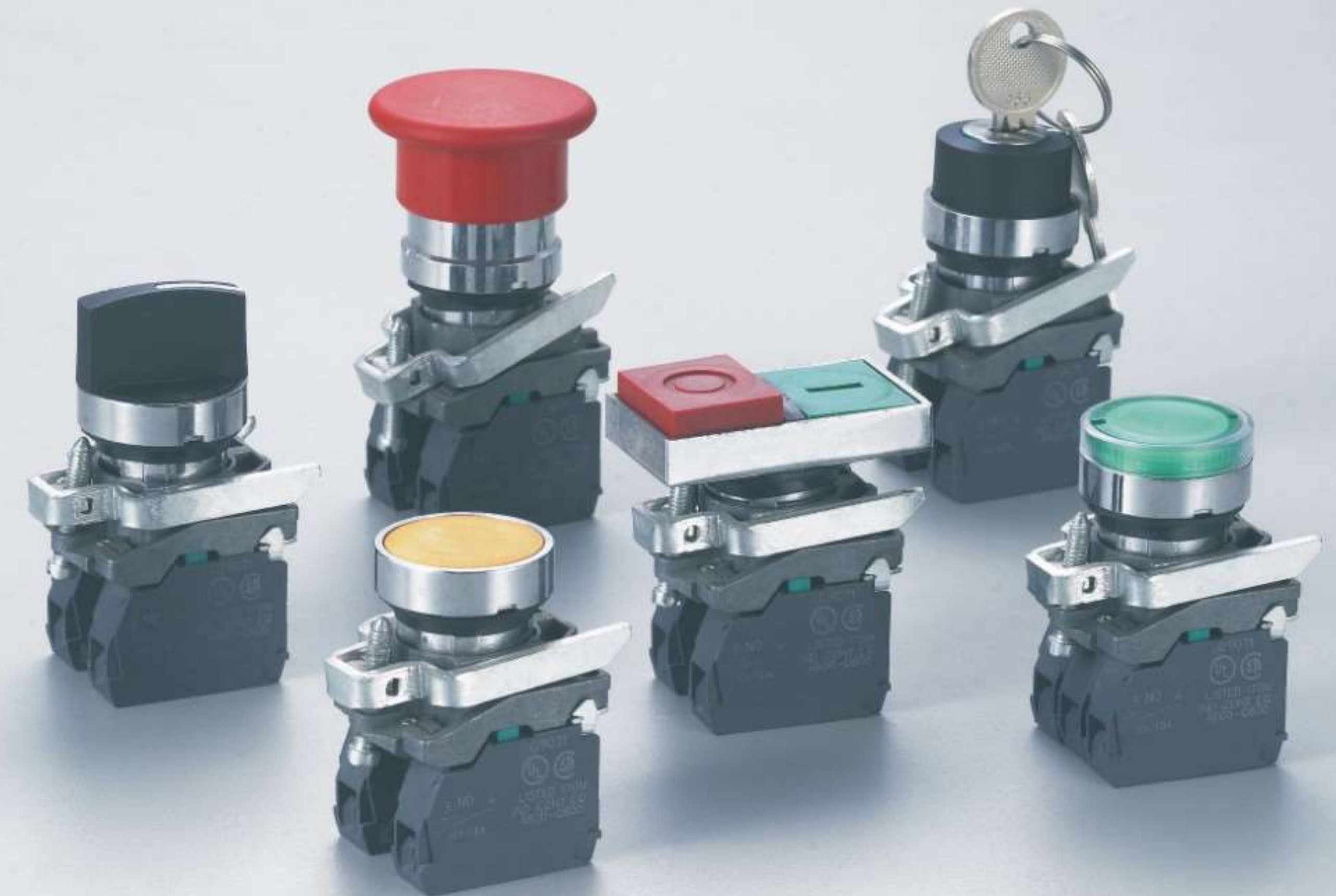

该系列按钮适用于电压至 660V 电流 50Hz 的交流控制电路, 直流电压低于 400V,

主要用于控制信号和连锁的作用。按钮的主体采用锌合金、高档抗阻燃塑料。接触采用特殊的银合金材料, 具有高抗电蚀效果
该系列信号灯是合适的电器交流电压至 380V/50Hz 电路, 直流电压 380V 以下。该产品性能良好, 用作指示信号、警告信号、紧急信号等

产品符合 GB/T14048.5 和 IEC60947-5-1 要求, 所有产品已通过 CE、ISO9001、ROHS 和 UL 认证

□产品概述

该系列按钮适用于电压至 660V 电流 50Hz 的交流控制电路，直流电压低于 400V，主要用于控制信号和联锁的作用。

按钮的主体采用锌合金、高档阻燃塑料。接触采用为特殊的银合金材料，具有高抗电蚀效果。

该系列信号灯是合适的电器交流电压至 380V/50Hz 电路，直流电压 380V 以下。该产品性能良好，用作指示信号、警告信号、紧急信号等。

我们的产品符合 GB/T14048.5 和 IEC60947-5-1 要求，所有产品已通过 CE、ISO9001、ROHS 和 UL 认证。

□工作环境

1. 环境温度: $-25^{\circ}\text{C} \sim +55^{\circ}\text{C}$;
2. 空气相对湿度: $\leq 85\%$;
3. 正常工作条件: 振动频率为 2-80Hz, 加速度 0.7g/h;
4. 污染等级 III, 安装排序 III, 防护等级可达 IP65;
5. 海拔: ≤ 2000 米。

注意:

PG 表示纯绿色, PW 表示纯白色。

□主要技术参数 Main technical parameter

●按钮基本参数 Basic technical of button

额定绝缘电压 Rated insulation voltage	AC 600V(50/60Hz)	
对流电流 Convective current	10A	
绝缘电阻 Insulation resistance	$\geq 50\text{M}\Omega$	
接触电阻 Contact resistance	$\leq 25\text{Min}\Omega$	
机械寿命 Mechanical life	100×10^4 (Pushbutton)	50×10^4 (Selector switch/Key switches)
电气寿命 Electrical life	500×10^4 (Pushbutton)	250×10^4 (Selector switch/Key switches)

●信号灯基本参数 Basic technical of signal lamp

绝缘电阻 Insulation resistance	$\geq 50\text{M}\Omega$
接触电阻 Contact resistance	$\leq 25\text{Min}\Omega$
Pf 耐压 Pf withstand voltage	AC 2.5KV/min
电压波 Voltage wave	$\pm 20\%$ 10A
亮度 Brightness	$60\text{cd}/\text{m}^2$
连续工作寿命 Continuous working life	100×10^4 h

□Products instruction

The push button series are used in controlling circuit of AC voltage up to 660V/AC 50Hz, and DC voltage below 400V. It is used for controlling signal and interlocking purposes. The main body of the push buttons adopts zinc alloy and high-grade anti-flam plastic. The contact adopts special silver alloy in order to enjoy the benefit of high anti-electrical erosion. The signal lamp series are suitable for electrical appliances circuit of AC voltage up to 380V/50Hz, and DC voltage below 380V. It is ideal for using as indicating signals, warning signals, emergency signals, etc.

Our products comply with GB/T14048.1 and IEC60947-5-1, all products are CE, ISO9001, ROHS and UL certified.











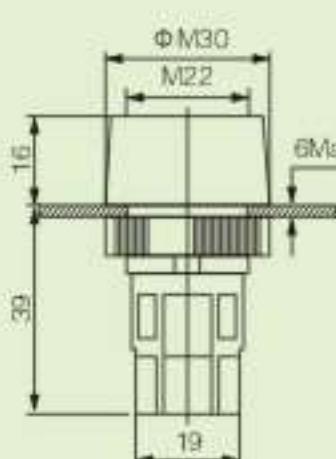

□Work environment

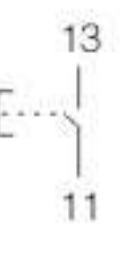
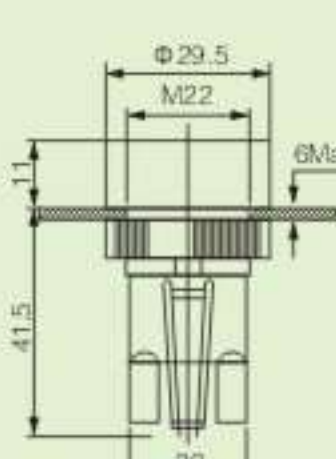
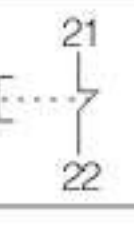
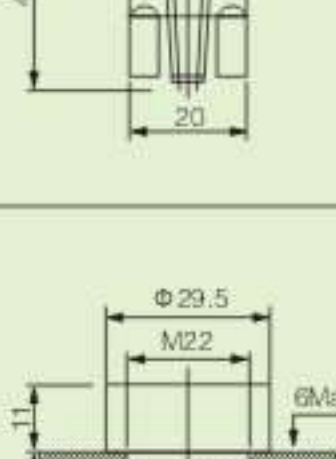
1. Surrounding temperature: $-25^{\circ}\text{C} \sim +55^{\circ}\text{C}$;
2. Air relative humidity: $\leq 85\%$;
3. It can be normally work under following condition: Vibration frequency is 2-80Hz and acceleration speed is 0.7g/h;
4. Pollution grade III, installation sort is III, protection grade is up to IP65;
5. Altitude: ≤ 2000 m.

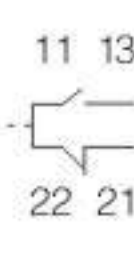
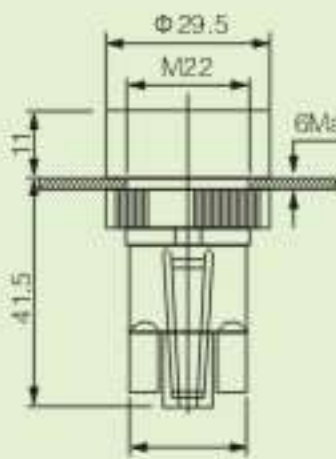
Note: PG denotes pure green; PW denotes pure white.

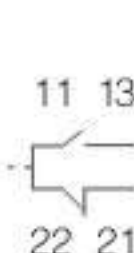
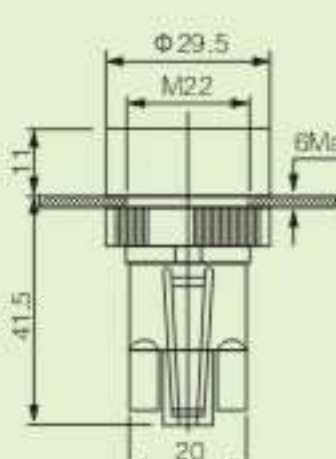

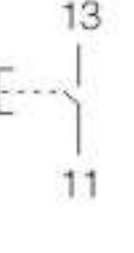
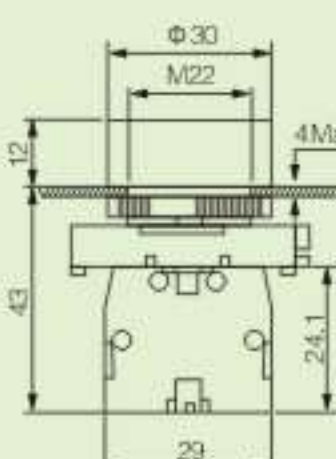
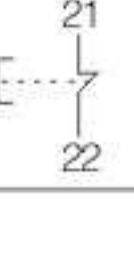
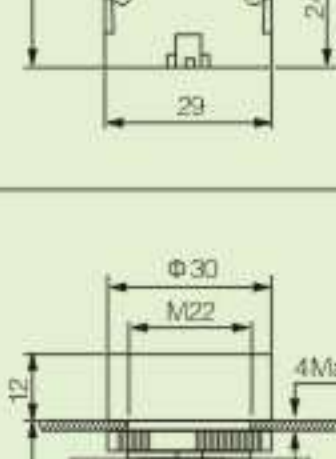

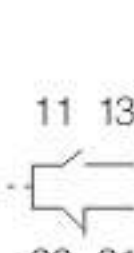
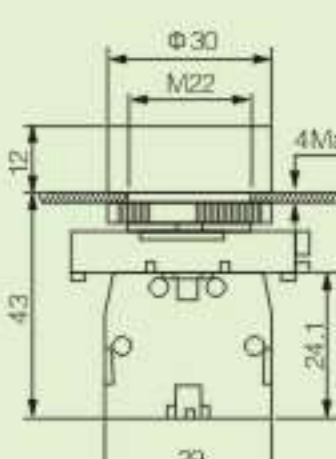



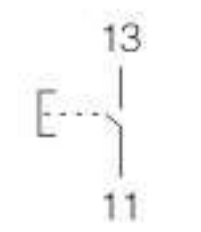
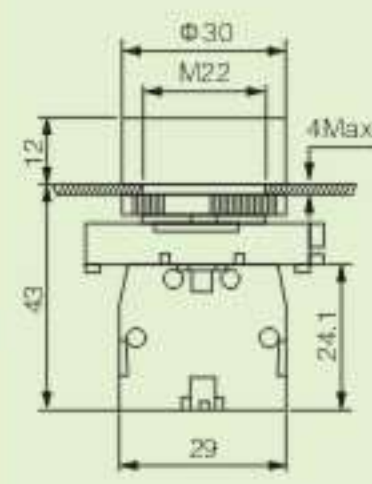
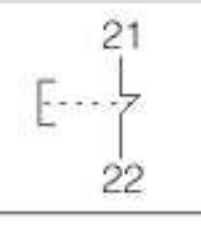

YB2(XB2、LAY5)系列按钮

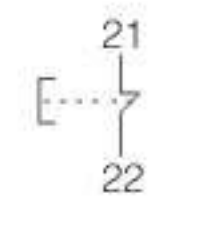
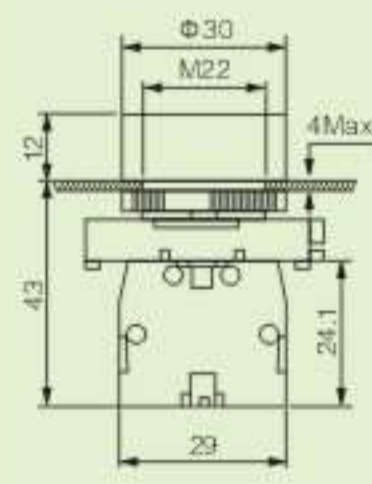
YB2(XB2、LAY5) Push button series

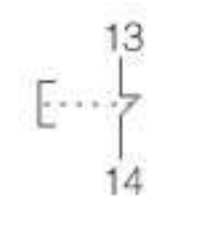
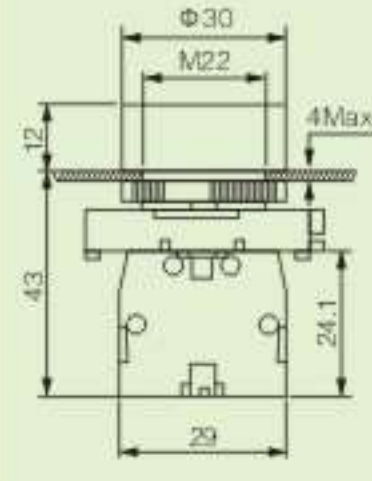
按钮 Push button	说明 Description	触点类型 Contact type	电路 Circuit	颜色 Color	型号 Type	外形尺寸 Dimensions
	简易指示灯 For use with incandescent bulb (included) BA9S base fitting neno(BA9S)	230V 50-60Hz 220V~240V bulb		○ White ● Green ● Red ● Yellow ● Blue	YB2-EV441 YB2-EV443 YB2-EV444 YB2-EV445 YB2-EV446	
YB2-EV443						
	按钮 弹簧复位 Flush button Spring return	N/O		○ White ● Green ● Green Start ● Yellow ● Blue	YB2-EA121 YB2-EA131S YB2-EA151 YB2-EA161	
YB2-EA142		N/C		● Red ● Red Stop	YB2-EA142 YB2-EA142S	
	按钮 弹簧复位 Flush button Spring return	N/O+N/C		○ White ● Green ● Red ● Yellow	LAY5-EA125 LAY5-EA135 LAY5-EA145 LAY5-EA155	
YB2-EA135						
	按钮 弹簧自持 Flush button Latching	N/O N/C N/O+N/C		○ White ● Green ● Red ● Yellow	YB2-EH131 YB2-EH142 YB2-EH135 YB2-EH145	
YB2-EH135						
	按钮 弹簧复位 Flush button Spring return	N/O		○ White ● Green ● Red ● Yellow ● Blue	YB2-EA11 YB2-EA21 YB2-EA31 YB2-EA51 YB2-EA61	
YB2-EA31		N/C		● Red	YB2-EA42	
	按钮 弹簧复位 Flush button Spring return	N/O+N/C		○ White ● Green ● Red ● Yellow ● Blue ● Red	YB2-EA15 YB2-EA25 YB2-EA35 YB2-EA55 YB2-EA65 YB2-EA45	
YB2-EA45						

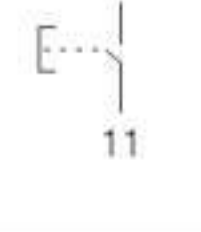
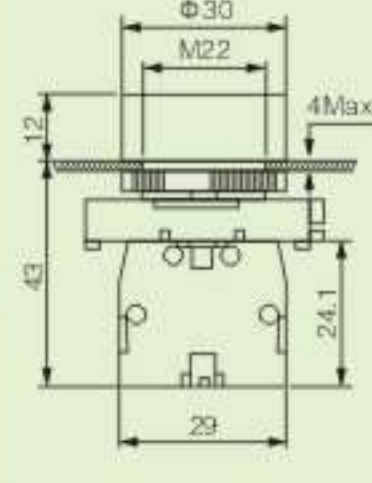
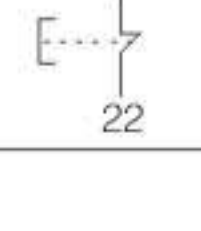

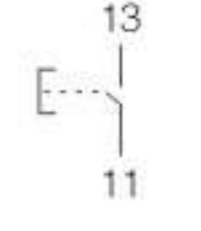
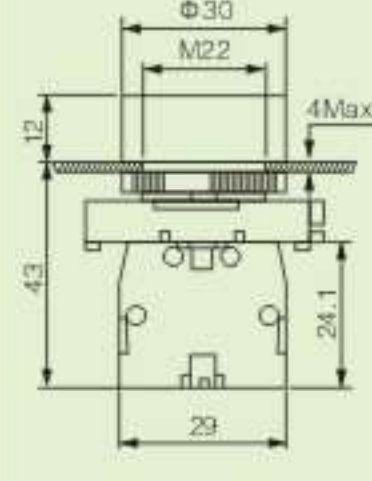

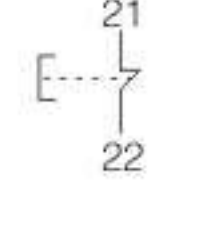
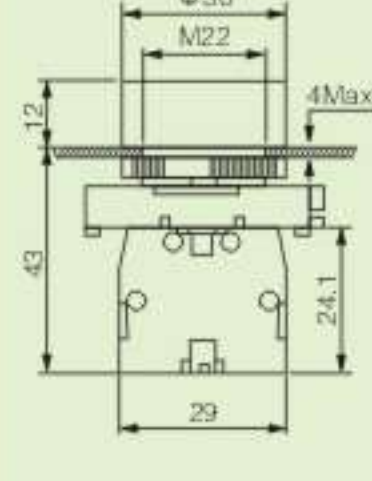



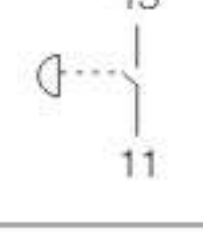
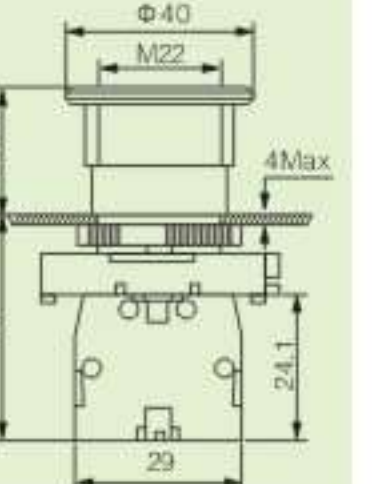
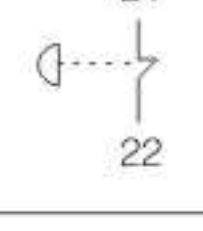

YB2(XB2、LAY5)系列按钮

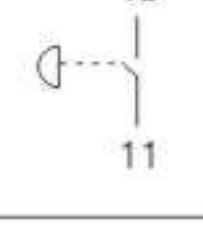
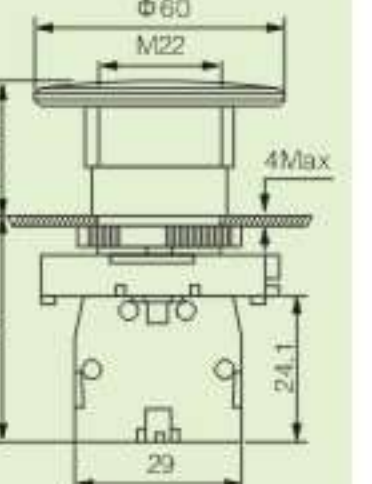
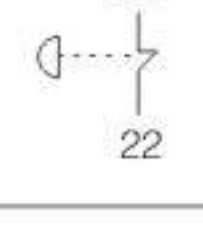
YB2(XB2、LAY5) Push button series

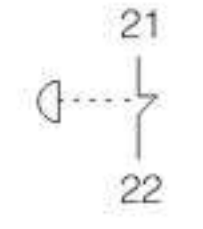
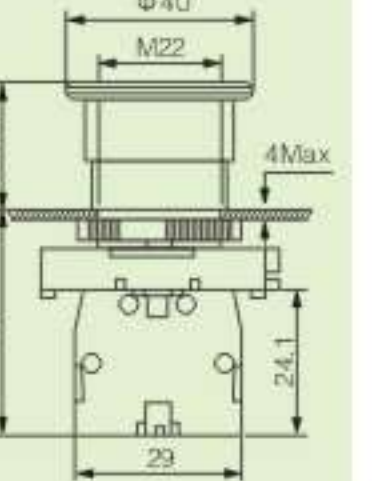
按钮 Push button	说明 Description	触点类型 Contact type	电路 Circuit	颜色 Color	型号 Type	外形尺寸 Dimensions
	防水按钮 弹簧复位 Flush button (With water-pooof cover) Unmarked Ip65	N/O		○ White ● Black ● Green ● Yellow ● Blue	YB2-EP11 YB2-EP21 YB2-EP31 YB2-EP51 YB2-EP61	
		N/C		● Red	YB2-EP42	
	标志式按钮 弹簧复位 Flush button Spring return	N/C		● Red ● Red Stop	YB2-EA4322 YB2-EA4342	
	标志式按钮 弹簧复位 Flush button Spring return Marked	N/O		● Green ● Green ⊕ White ● Black ● Green Start ● Black Start	YB2-EA3311 YB2-EA3361 YB2-EA3341 YB2-EA3351 YB2-EA5331 YB2-EA5321	
	凸头按钮 弹簧复位 Convex button Spring return	N/O		○ White ● Green ● Red ● Yellow ● Blue	YB2-EL11 YB2-EL21 YB2-EL31 YB2-EL51 YB2-EL61	
		N/C		● Red	YB2-EL42	
	凸头标志式按钮 弹簧复位 Convex button Spring return Marked	N/O		⊕ White ● Black	YB2-EL3341 YB2-EL3351	
	按钮 弹簧复位 Flush button Spring return	N/C		● Red ● Red Stop	YB2-EL4322 YB2-EL4342	

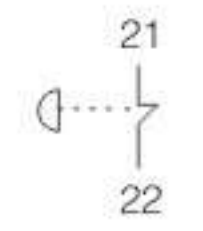
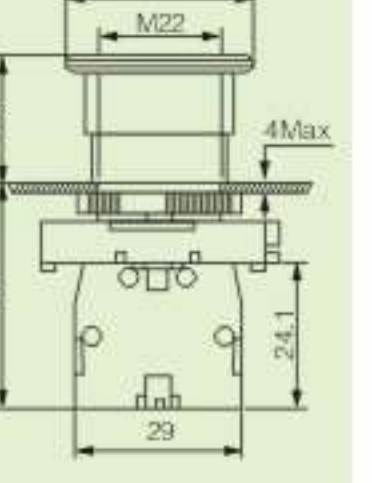

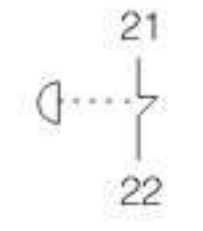
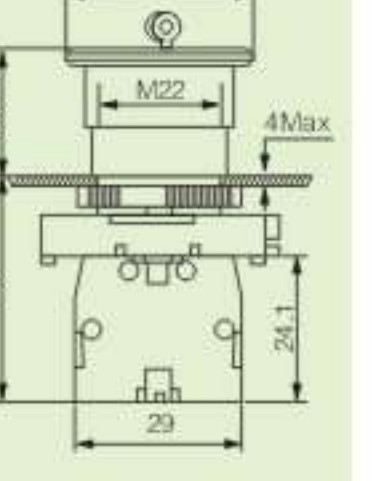

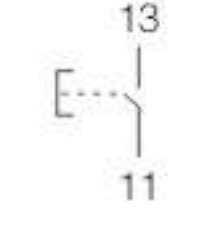
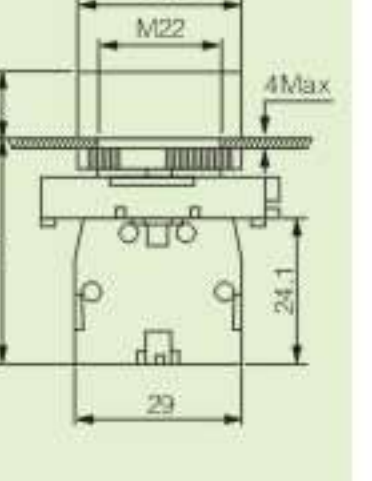



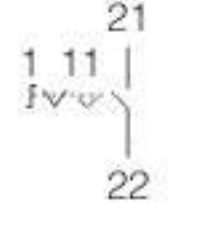
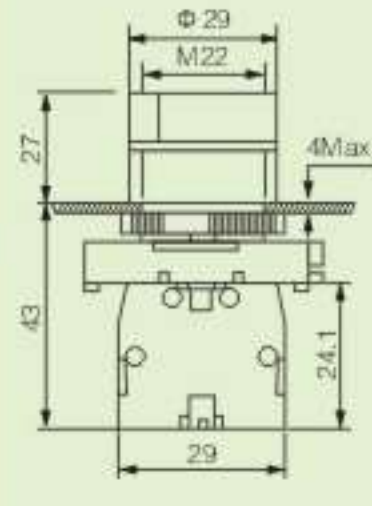
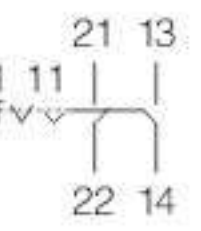

YB2(XB2、LAY5)系列按钮

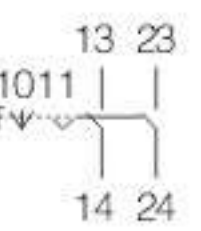
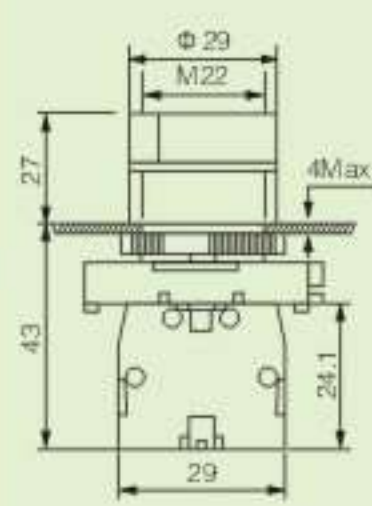
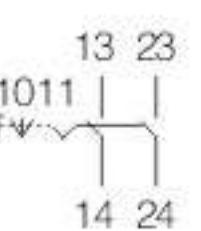
YB2(XB2、LAY5) Push button series

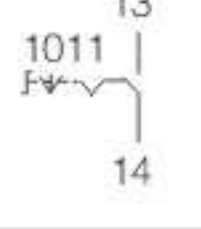
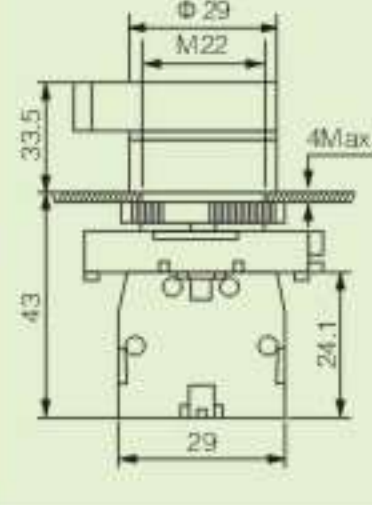
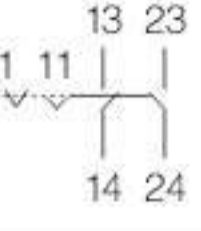
按钮 Push button	说明 Description	触点类型 Contact type	电路 Circuit	颜色 Color	型号 Type	外形尺寸 Dimensions
	蘑菇头按钮 弹簧复位 Mushroom head Spring return	N/O		● Black Φ40 ● Green Φ40	YB2-EC21 YB2-EC31	
		N/C		● Red Φ30 ● Red Φ40	YB2-EC442 YB2-EC42	
	蘑菇头按钮 弹簧复位 Mushroom head Spring return	N/O		● Black Φ60 ● Green Φ60	YB2-ER21 YB2-ER31	
		N/C		● Red Φ60	YB2-ER42	
	蘑菇头按钮 转动复位 Turn to release	N/C		● Red Φ30 ● Red Φ40 ● Red Φ60	YB2-ES442 YB2-ES542 YB2-ES642	
	推拉式按钮 Pushi-pull	N/C		● Red Φ40	YB2-ET42	
	锁扣式蘑菇头 紧急停止按钮 Turn to release by key (Key n° 445)	N/C		● Red Φ40	YB2-ES142	
	防水标志式 按钮 With protection Spring return	N/O		⊕ White ● Black	YB2-EU3341 YB2-EU3351	

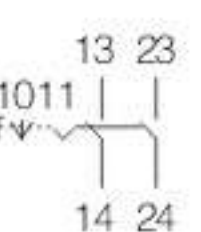
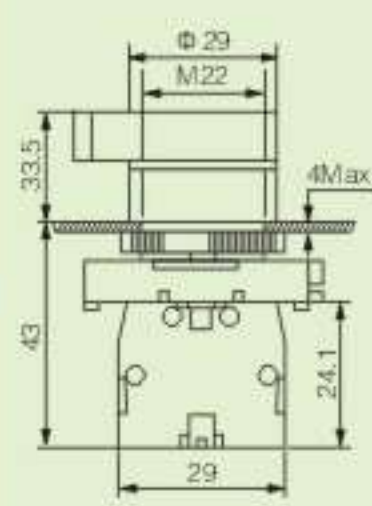
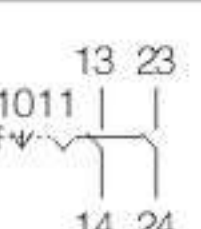

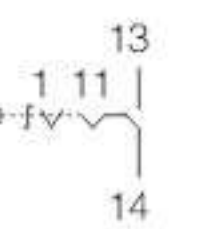
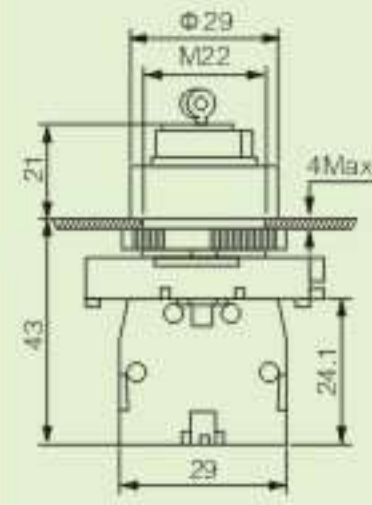
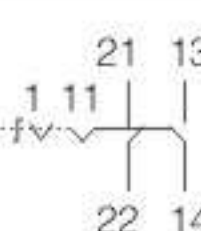

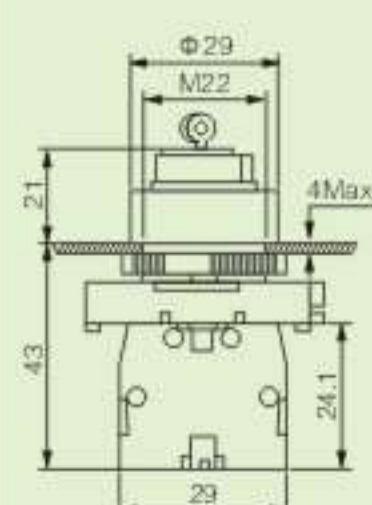



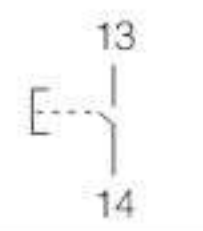
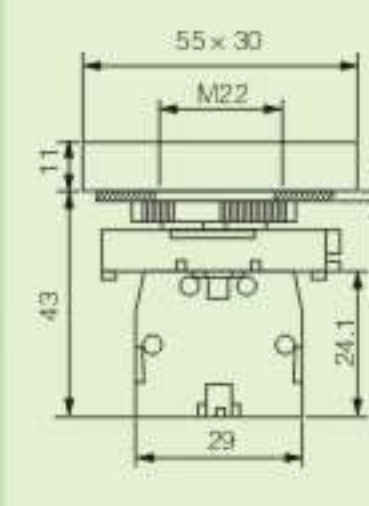
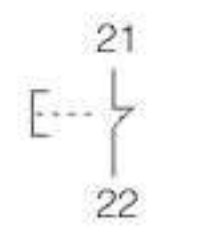

YB2(XB2、LAY5) 系列按钮

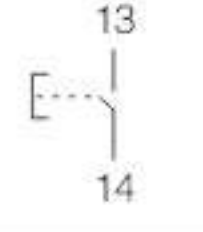
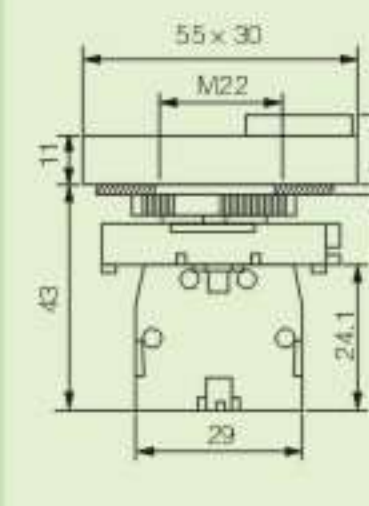
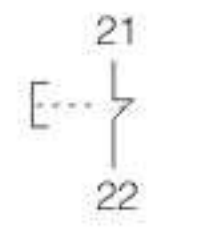
YB2(XB2、LAY5) Push button series

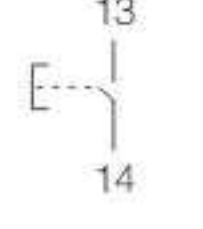
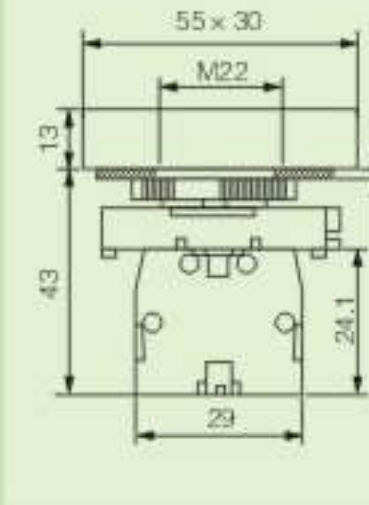
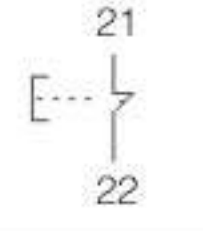

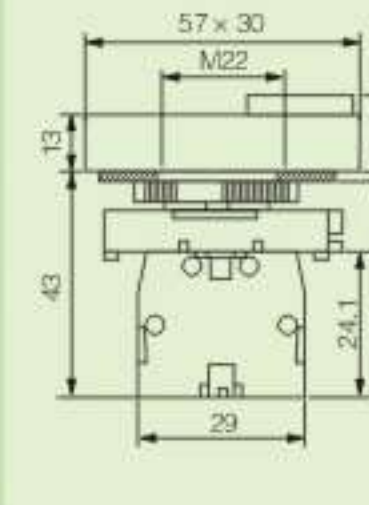
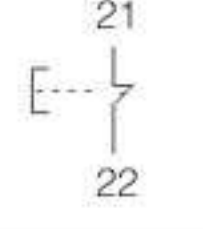

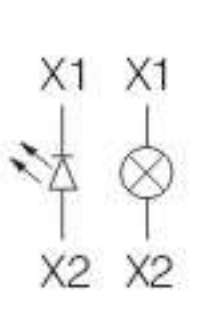
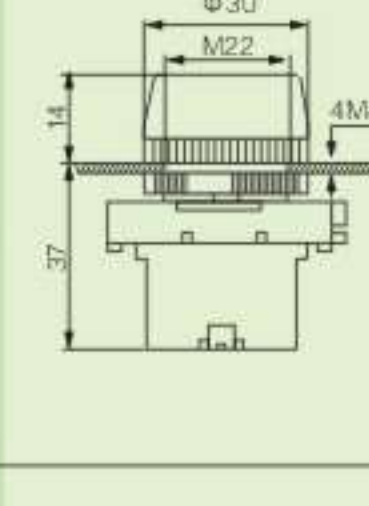

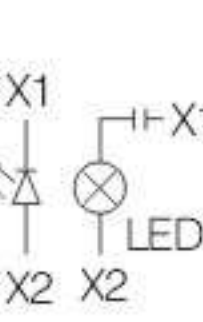
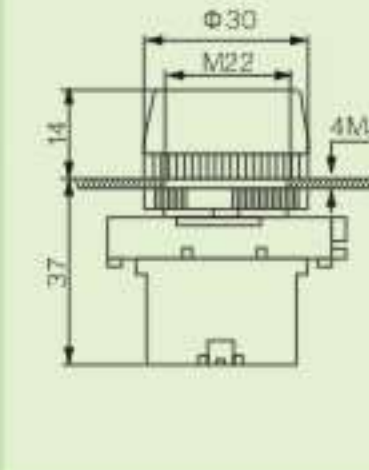

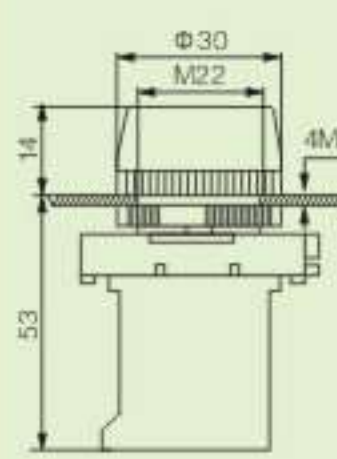

按钮 Push button	说明 Description	触点类型 Contact type	电路 Circuit	位置 Locality	型号 Type	外形尺寸 Dimensions
	标准手柄 Standard handle 2 position	N/O		▽	YB2-ED21	
				▽	YB2-ED41	
		N/O+N/C		▽	YB2-ED25	
				▽	YB2-ED45	
	标准手柄 Standard handle 2 position	N/O+N/O		▽	YB2-ED33	
				▽	YB2-ED53	
		N/O+N/O		▽	YB2-ED73	
				▽	YB2-ED83	
	长手柄 Long handle 2 position	N/O		▽	YB2-EJ21	
				▽	YB2-EJ41	
		N/O+N/C		▽	YB2-EJ25	
				▽	YB2-EJ45	
	长手柄 Long handle 2 position	N/O+N/O		▽	YB2-EJ33	
				▽	YB2-EJ53	
		N/O+N/O		▽	YB2-EJ73	
				▽	YB2-EJ83	
	钥匙开关 Key switches Key n° 455 2 position	N/O		▽	YB2-EG21	
				▽	YB2-EG41	
		N/O+N/C		▽	YB2-EG25	
				▽	YB2-EG45	
	钥匙开关 Key switches Key n° 455 3 position	N/O+N/O		▽	YB2-EG33	
				▽	YB2-EG53	
				▽	YB2-EG03	
				▽	YB2-EG73	

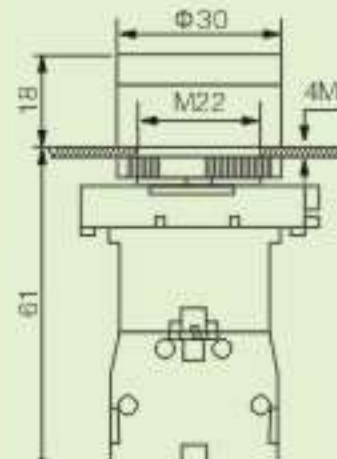
YB2(XB2、LAY5) 系列按钮

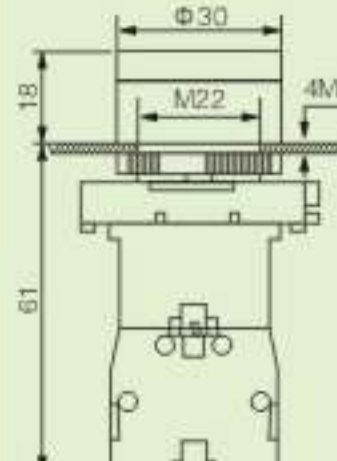

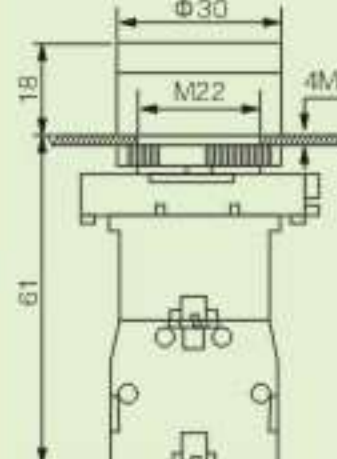

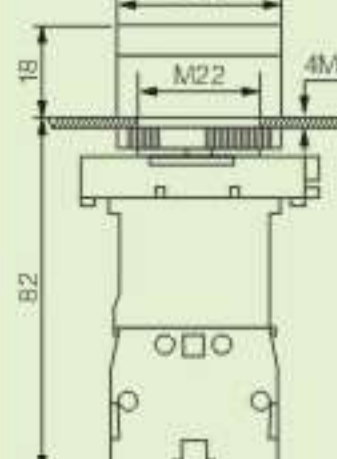

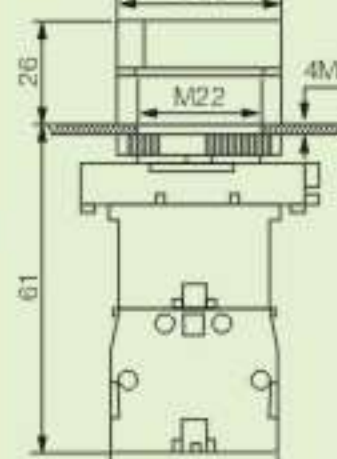

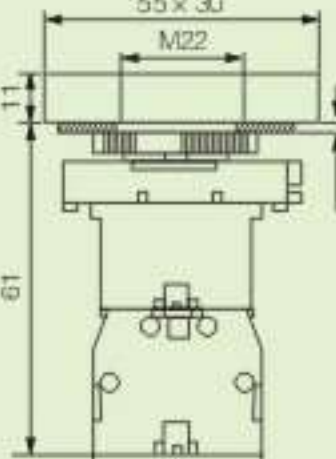

YB2(XB2、LAY5) Push button series

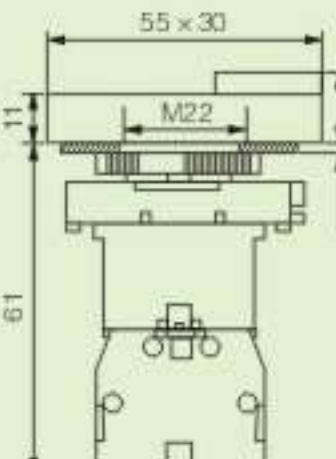
按钮 Push button	说明 Description	触点类型 Contact type	电路 Circuit	颜色 Color	型号 Type	外形尺寸 Dimensions	
	双头按钮 1 flush green button 1 flush red button Unmarked Ip40 Without pilot light	N/O		Green	YB2-EL8325		
		N/C		Red			
	双头按钮 1 flush green button 1 convex red button Marked Ip40 Without pilot light	N/O		Green	YB2-EL8425		
		N/C		Red			
	双头防水按钮 Without pilot light 1 flush green button 1 flush red button (with water-proof cover) Unmarked IP65	N/O		Green	YB2-EL9325		
		N/C		Red			
	双头防水按钮 Without pilot light 1 flush green button 1 flush red button (with water-proof cover) Unmarked IP65	N/O		Green	YB2-EL9425		
		N/C		Red			
	直接式指示灯 Direct bulb included BA9S base fitting Neon LED (BA9S)	220~240V 50~60Hz		○ White	YB2-EV61		
				● Green			YB2-EV63
				● Red			YB2-EV64
				● Yellow			YB2-EV65
				● Blue			YB2-EV66
	阻容式指示灯 Via integral resistance BA9S LED 24V bulb supplied	130V 220~240V 50~60Hz		○ White/PW	YB2-EV71		
				● Green/PG			YB2-EV73
				● Red			YB2-EV74
				● Yellow			YB2-EV75
				● Pure Blue			YB2-EV76

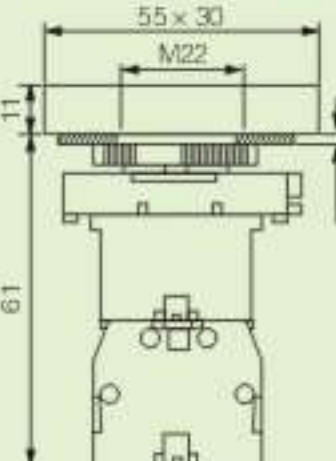
YB2(XB2、LAY5)系列按钮
YB2(XB2、LAY5) Push button series

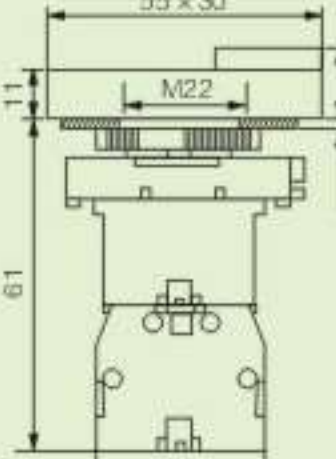

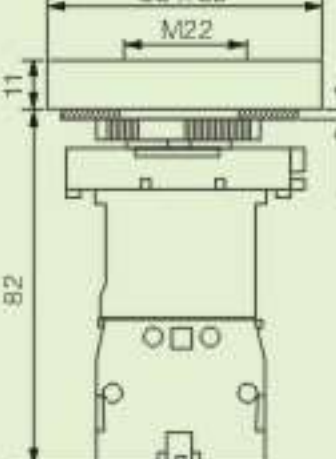

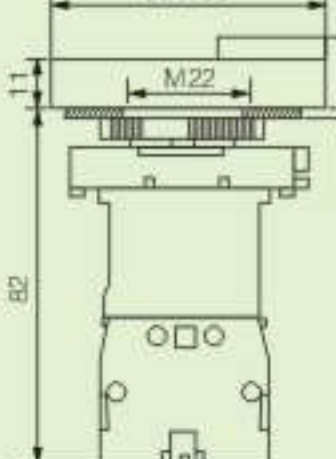



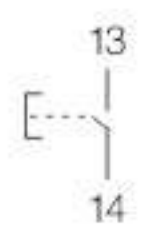
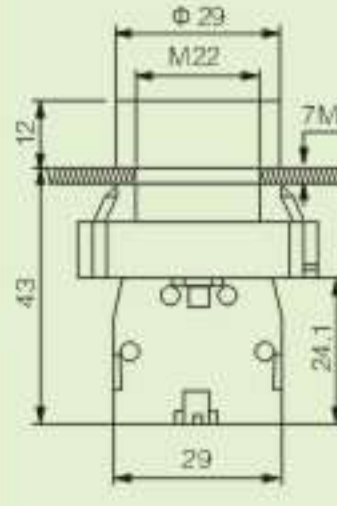
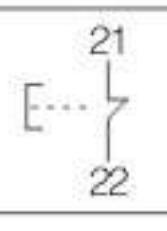

按钮 Push button	说明 Description	触点类型 Contact type	电路 Circuit	颜色 Color	型号 Type	外形尺寸 Dimensions
	变压器式指示灯 Via integral transformer 1.2VA 6V BA9S bulb supplied	110~130V/60Hz 220~240V/60Hz		○ White ● Green ● Red ● Yellow ● Blue	YB2-EV31 YB2-EV33 YB2-EV34 YB2-EV35 YB2-EV36 YB2-EV41 YB2-EV43 YB2-EV44 YB2-EV45 YB2-EV46	
	带灯按钮 Direct bulb supplied Neon LED (BA9S)	N/O 220~240V N/C	X1 X1 13 X2 X2 14 X1 X1 21 X2 X2 22	○ White ● Green ● Yellow ● Blue ● Red	YB2-EW3161 YB2-EW3361 YB2-EW3561 YB2-EW3661 YB2-EW3462	
	带灯按钮 Via integral resistance BA9S LED 24V bulb supplied	N/O 130V 220~240V N/C	X1 X1 13 X2 14 X1 X1 21 X2 22	○ White/PW ● Green/PG ● Yellow ● Pure Blue ● Red	YB2-EW3171 YB2-EW3371 YB2-EW3571 YB2-EW3671 YB2-EW3472	
	带灯防水按钮 Via integral resistance BA9S bulb supplied (with water-proof cover) LED 24V (BA9S) IP65	N/O 220~240V N/C	X1 X1 13 X2 X2 14 X1 X1 21 X2 X2 22	○ White/PW ● Green/PG ● Yellow ● Pure Blue ● Red	YB2-EPW3161 YB2-EPW3171 YB2-EPW3361 YB2-EPW3371 YB2-EPW3561 YB2-EPW3661 YB2-EPW3671 YB2-EPW3462 YB2-EPW3472	
	变压器式带灯按钮 Via integral transformer 1.2VA 6V BA9S bulb supplied	N/O 220V/50Hz N/C	X1 13 X2 14 X1 13 X2 14	○ White/PW ● Green/PG ● Yellow ● Pure Blue ● Red	YB2-EW3141 YB2-EW3341 YB2-EW3541 YB2-EW3641 YB2-EW3442	
	带灯旋钮 2 Position stay put Standard handle Direct supply 220/240V BA9S bulb Neon LED	N/O + N/C	X1 X1 21 13 X2 X2 22 14 X1 X1 13 23 X2 X2 14 24	● Green ● Yellow ● Blue ○ White ● Red ● Green ● Yellow ● Blue ○ White ● Red	YB2-EK2361 YB2-EK2561 YB2-EK2661 YB2-EK2761 YB2-EK2461 YB2-EK2375 YB2-EK2575 YB2-EK2675 YB2-EK2775 YB2-EK2475	

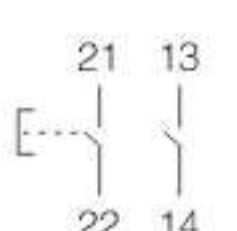
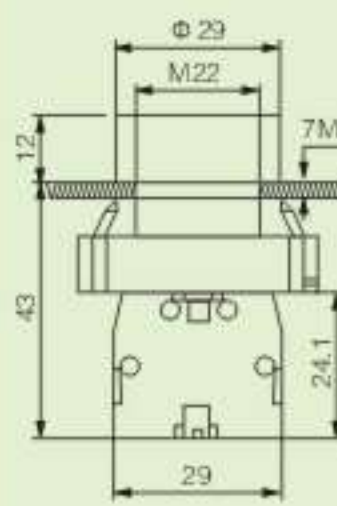
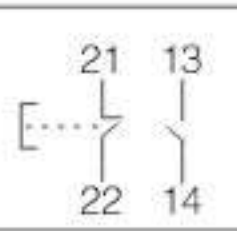
YB2(XB2、LAY5)系列按钮
YB2(XB2、LAY5) Push button series

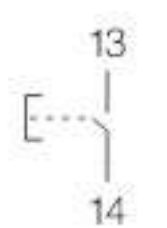
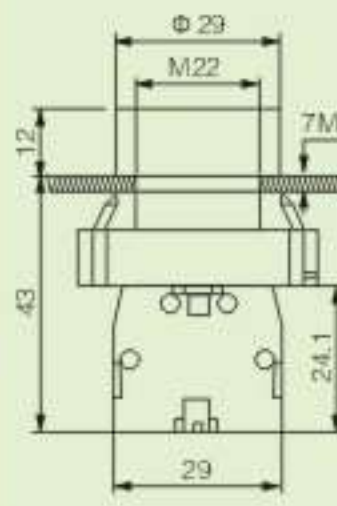
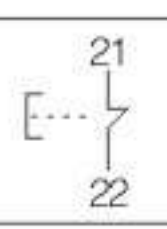
按钮 Push button	说明 Description	触点类型 Contact type	电路 Circuit	颜色 Color	型号 Type	外形尺寸 Dimensions
	双头带灯按钮 Unmarked IP40 1 flush green button 1 flush red button 1 pilot light with yellow lens direct supply 220~240V BA9S bulb		13 14	■ Red □ Yellow/White ■ Green	YB2-EW8365	
	1 flush green button 1 convex red button Marked IP40 Neon (BA9S) LED		21 22	■ Red □ Yellow/White ■ Green	YB2-EW8465	
	双头带灯按钮 Unmarked IP40 1 flush green button 1 flush red button 1 pilot light with yellow lens direct supply 220~240V BA9S bulb with resistance Marked IP40 24V (BA9S) LED		13 14	■ Red □ Yellow/White ■ Green	YB2-EW8375	
	1 convex red button 1 flush green button		21 22	■ Red □ Yellow/White ■ Green	YB2-EW8475	
	双头带灯 带变压器按钮 Unmarked IP40 1 flush green button 1 flush red button 1 pilot light with yellow lens direct supply 220V BA9S bulb 6V via integral transformer 1.2VA		13 14	■ Red □ Yellow/White ■ Green	YB2-EW8345	
	1 flush green button Marked IP40		21 22	■ Red □ Yellow/White ■ Green	YB2-EW8445	

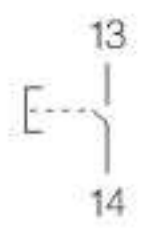
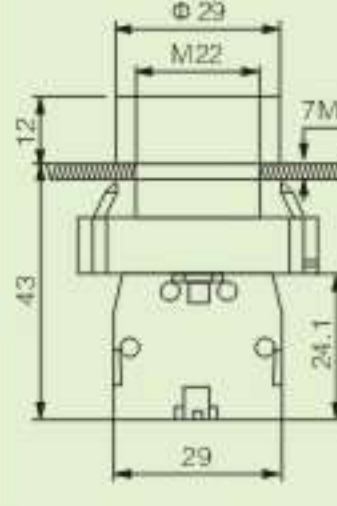
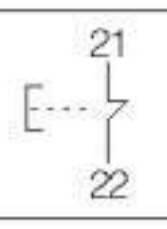

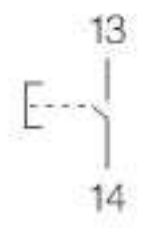
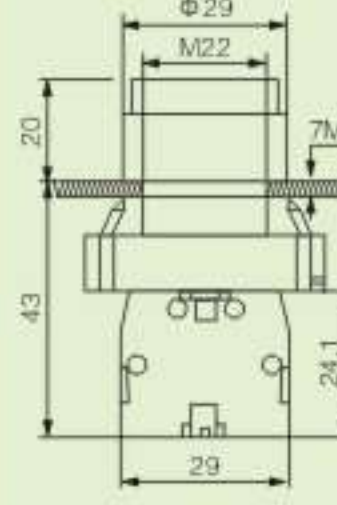
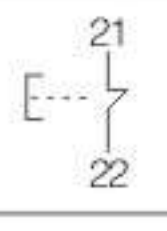

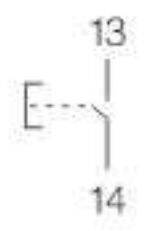
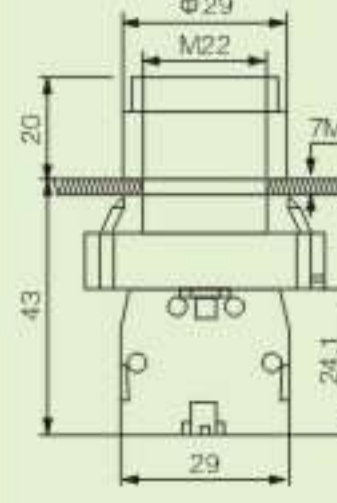
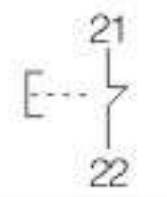

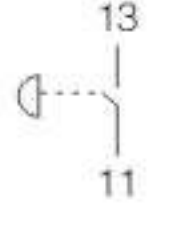
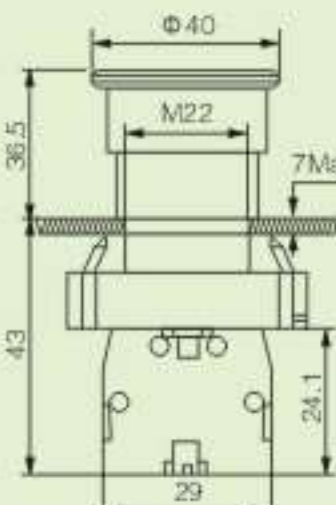
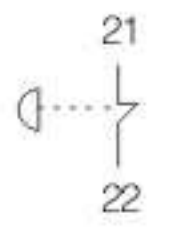

YB2(XB2、LAY5)系列按钮

YB2(XB2、LAY5) Push button series

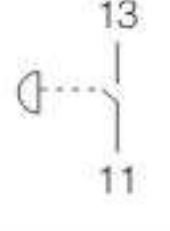
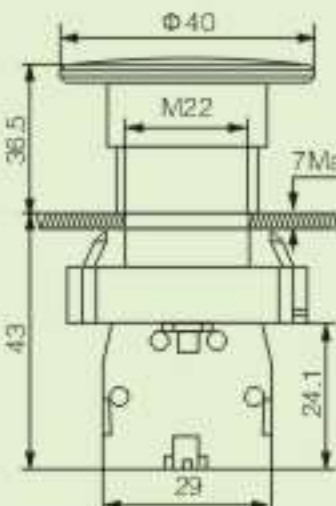
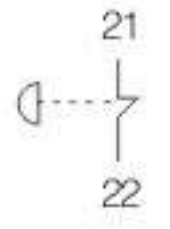
按钮 Push button	说明 Description	触点类型 Contact type	电路 Circuit	颜色 Color	型号 Type	外形尺寸 Dimensions
	按钮弹簧自复 Flush button Spring return	N/O		○ White ● Black ● Green ● Yellow ● Blue	YB2-BA11 YB2-BA21 YB2-BA31 YB2-BA51 YB2-BA61	
		NC		● Red	YB2-BA42	
	按钮弹簧自复 Flush button Spring return	N/O+N/O		● Black ● Green ● Yellow ● Blue	YB2-BA25 YB2-BA35 YB2-BA55 YB2-BA65	
		N/O+N/O		● Red	YB2-BA45	
	防水按钮 弹簧自复 Flush button (With water-proof cover) Unmarked IP65	N/O		○ White ● Black ● Green ● Yellow ● Blue	YB2-BP11 YB2-BP21 YB2-BP31 YB2-BP51 YB2-BP61	
		NC		● Red	YB2-BP42	
	指示按钮 弹簧自复 Flush button Spring return Marked	N/O		● Green ● Green ○ White ● Black ● Green Start ● Black Start	YB2-BA3311 YB2-BA3361 YB2-BA3341 YB2-BA3351 YB2-BA5331 YB2-BA5321	
		NC		● Red ● Red Stop	YB2-BA4322 YB2-BA4342	
	凸头按钮 弹簧自复 Convex button Spring return	N/O		● Black ● Green ● Yellow ● Blue	YB2-BL21 YB2-BL31 YB2-BL51 YB2-BL61	
		NC		● Red	YB2-BL42	
	标志凸头按钮 Convex button Spring return Marked	N/O		● Green ● Green ○ White ● Black	YB2-BL3311 YB2-BL3361 YB2-BL3341 YB2-BL3351	
		NC		● Red ● Red Stop	YB2-BL4322 YB2-BL4342	

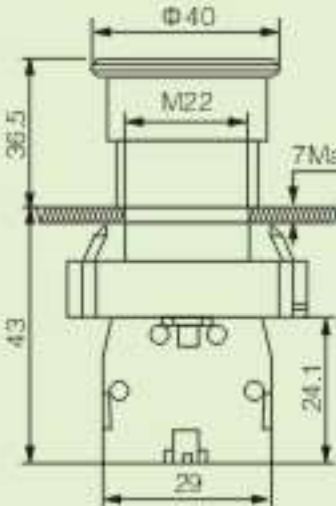
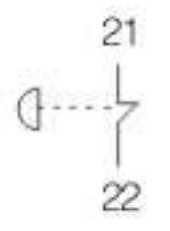
YB2(XB2、LAY5)系列按钮

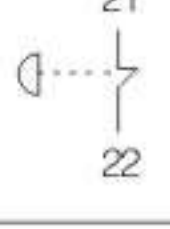
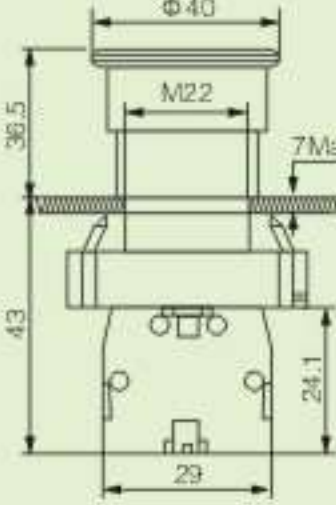
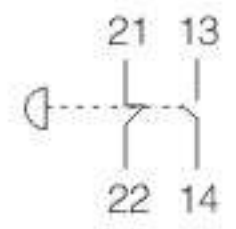
YB2(XB2、LAY5) Push button series

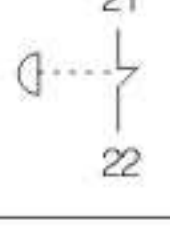
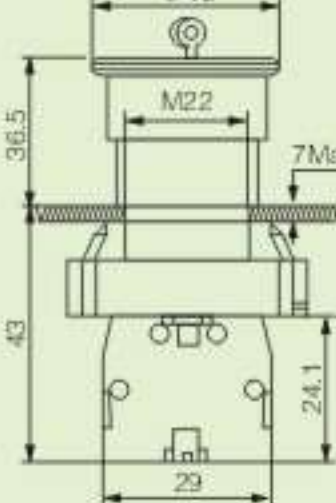
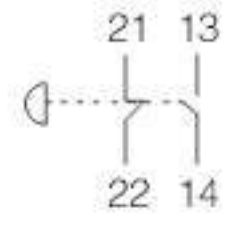
按钮 Push button	说明 Description	触点类型 Contact type	电路 Circuit	颜色 Color	型号 Type	外形尺寸 Dimensions
	蘑菇头按钮 弹簧复位 Mushroom head Spring return	N/O		● Black Φ40 ● Green Φ40	YB2-BC21 YB2-BC31	
		NC		● Red Φ40	YB2-BC42	
	蘑菇头按钮 弹簧复位 Mushroom head Spring return	N/O		● Black Φ40 ● Green Φ40	YB2-BR21 YB2-BR31	
		NC		● Red Φ40	YB2-BR42	
	蘑菇头按钮 转动复位 Turn to release	N/C		● Red Φ30 ● Red Φ40	YB2-BS442 YB2-BS542	
		N/C		● Red Φ60	YB2-BS642	
	推拉式按钮 Push-pull	N/C		● Red Φ40	YB2-BT42	
		N/O + NC		● Red Φ40	YB2-BT45	
	钥匙复位 蘑菇头按钮 Turn to release by key (Key n° 445)	N/C		● Red Φ30 ● Red Φ40 ● Red Φ60	YB2-BS742 YB2-BS142 YB2-BS242	
		N/O + NC		● Red Φ40	YB2-BS145	



YB2(XB2、LAY5)系列按钮
YB2(XB2、LAY5) Push button series

按钮 Push button	说明 Description	触点类型 Contact type	电路 Circuit	位置 Locality	型号 Type	外形尺寸 Dimensions
	标准手柄 Standard handle 2 position	N/O		▽	YB2-BD21	
		N/O+N/C		▽	YB2-BD41	
	标准手柄 Standard handle 2 position	N/O+N/O		▽	YB2-BD25	
		N/O+N/O		▽	YB2-BD45	
	标准手柄 Standard handle 2 position	N/O+N/O		▽	YB2-BD33	
		N/O+N/O		▽	YB2-BD53	
		N/O+N/O		▽	YB2-BD73	
	长手柄 Long handle 2 position	N/O		▽	YB2-BJ21	
		N/O+N/C		▽	YB2-BJ41	
	长手柄 Long handle 2 position	N/O+N/O		▽	YB2-BJ25	
		N/O+N/O		▽	YB2-BJ45	
	长手柄 Long handle 2 position	N/O+N/O		▽	YB2-BJ33	
		N/O+N/O		▽	YB2-BJ53	
		N/O+N/O		▽	YB2-BJ73	
	钥匙开关 Key switches Key n° 455 2 position	N/O		▽	YB2-BG21	
		N/O+N/C		▽	YB2-BG41	
	钥匙开关 Key n° 455 2 position	N/O+N/O		▽	YB2-BG61	
		N/O+N/C		▽	YB2-BG25	
	钥匙开关 Key n° 455 2 position	N/O+N/O		▽	YB2-BG45	
		N/O+N/O		▽	YB2-BG65	
	钥匙开关 Key switches Key n° 455 3 position	N/O+N/O		▽	YB2-BG33	
		N/O+N/O		▽	YB2-BG53	
		N/O+N/O		▽	YB2-BG03	
		N/O+N/O		▽	YB2-BG73	





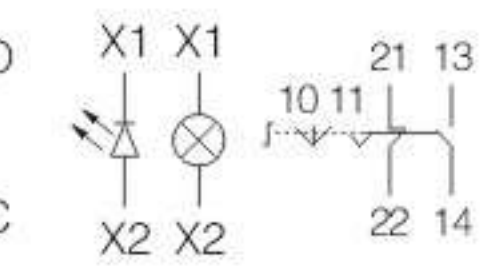
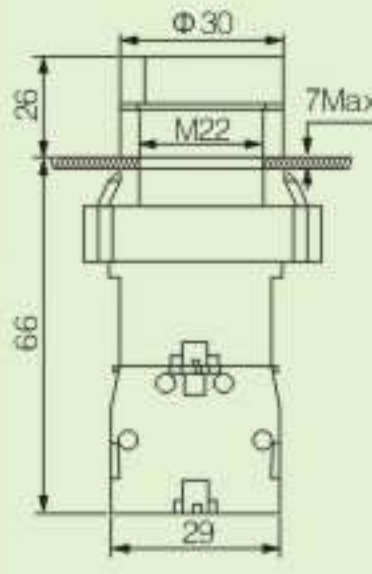
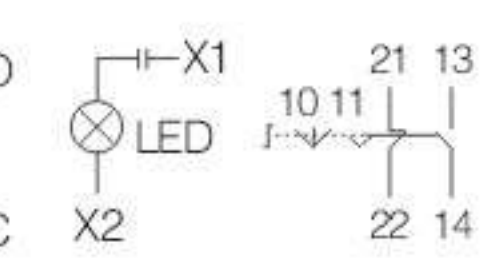
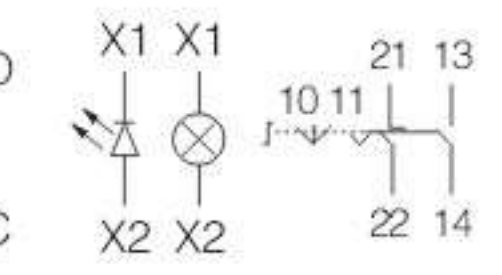

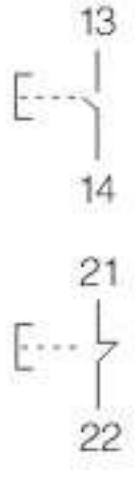
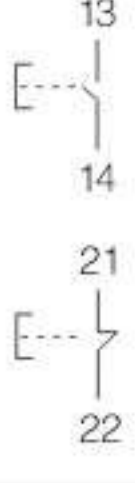
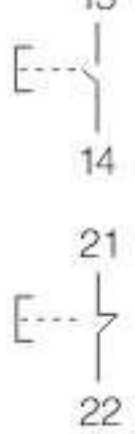



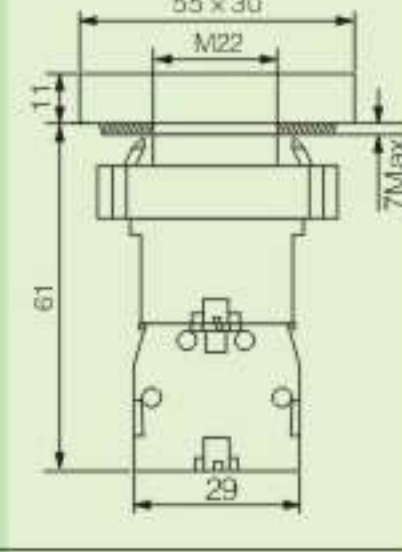

YB2(XB2、LAY5)系列按钮
YB2(XB2、LAY5) Push button series

按钮 Push button	说明 Description	触点类型 Contact type	电路 Circuit	颜色 Color	型号 Type	外形尺寸 Dimensions
	指示灯 Direct bulb included BA9S base fitting Neon LED	130V 220~240V 50~60Hz		○ White ● Green ● Red ● Yellow ● Blue	YB2-BV61 YB2-BV63 YB2-BV64 YB2-BV65 YB2-BV66	
		YB2-BV63				
	电容式指示灯 Via integral resistance BA9S LED 24V bulb supplied	130V 220~240V 50~60Hz		○ White/PW ● Green/PG ● Red ● Yellow ● Pure Blue	YB2-BV71 YB2-BV73 YB2-BV74 YB2-BV75 YB2-BV76	
		YB2-BV74				
	变压器式指示灯 Via integral transformer 1.2VA BA9S 6V bulb supplied	220~240V 50Hz		○ White ● Green ● Red ● Yellow ● Blue	YB2-BV41 YB2-BV43 YB2-BV44 YB2-BV45 YB2-BV46	
		YB2-BV44				
	带灯按钮 Direct bulb supplied Neon LED (BA9S)	N/O 220~240V		○ White ● Green ● Yellow ● Blue	YB2-BW3161 YB2-BW3361 YB2-BW3561 YB2-BW3661	
		N/C 220~240V		● Red	YB2-BW3462	
	电容式带灯按钮 Via integral resistance BA9S LED 24V bulb supplied	N/O 220~240V		○ White/PW ● Green/PG ● Yellow ● Pure Blue	YB2-BW3171 YB2-BW3371 YB2-BW3571 YB2-BW3671	
		N/C 220~240V		● Red	YB2-BW3472	
	防水式带灯按钮 Direct bulb supplied Neon LED (BA9S) (with water-proof cover) IP65	N/O 220~240V		○ White/PW ● Green/PG ● Yellow ● Pure Blue	YB2-BPW3161 YB2-BPW3171 YB2-BPW3361 YB2-BPW3371 YB2-BPW3561 YB2-BPW3571 YB2-BPW3661 YB2-BPW3671	
		N/C 220~240V		● Red	YB2-BPW3462 YB2-BPW3472	
	变压器式按钮 Via integral transformer 1.2VA BA9S 6V bulb supplied	N/O		○ White/PW ● Green/PG ● Yellow ● Pure Blue	YB2-BW3131 YB2-BW3331 YB2-BW3531 YB2-BW3631	
		N/C		● Red	YB2-BW3432	
	YB2-BPW3435					

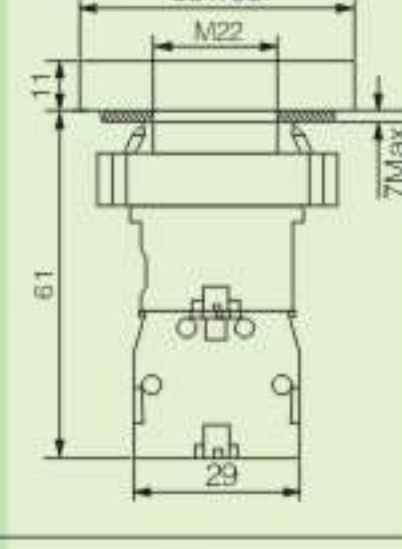
YB2(XB2、LAY5) 系列按钮
YB2(XB2、LAY5) Push button series

按钮 Push button	说明 Description	触点类型 Contact type	电路 Circuit	颜色 Color	型号 Type	外形尺寸 Dimensions
	2位带灯按钮 2 Position stay put Standard handle Direct supply Max 380V BAS9 bulb Neon LED	N/O + N/C		● Green/PG ● Yellow ● Pure Blue ○ White/PW ● Red	YB2-BK2365 YB2-BK2565 YB2-BK2665 YB2-BK2765 YB2-BK2465	
	2位带灯按钮 2 Position stay put Standard handle Direct supply 220/240V BAS9 24V LED with resistance	N/O + N/C		● Green ● Yellow ● Pure Blue ○ White ● Red	YB2-BK2375 YB2-BK2575 YB2-BK2675 YB2-BK2775 YB2-BK2475	
	3位带灯按钮 3 Position stay put Standard handle Direct supply 220/240V BAS9 bulb Neon LED	N/O + N/C		● Green/PG ● Yellow ● Pure Blue ○ White/PW ● Red	YB2-BK3365 YB2-BK3565 YB2-BK3665 YB2-BK3765 YB2-BK3465	
	双头按钮 Without pilot light 1 flush green button 1 flush red button IP40	N/O + N/C		■ Green/PG ■ Red	YB2-BL8325	
	双头按钮 Without pilot light 1 flush green button 1 convex red button Marked IP40	N/O + N/C		■ Green/PG ■ Red	YB2-BL8425	
双头防水按钮 Without pilot light 1 flush green button 1 flush red button (with water-proof cover) Unmarked IP65	N/O + N/C		○ White ■ Green ■ Red	YB2-BL9325		
双头防水按钮 Without pilot light 1 flush green button 1 flush red button (with water-proof cover) Unmarked IP65	N/O + N/C		○ White ■ Green ■ Red	YB2-BL9425		

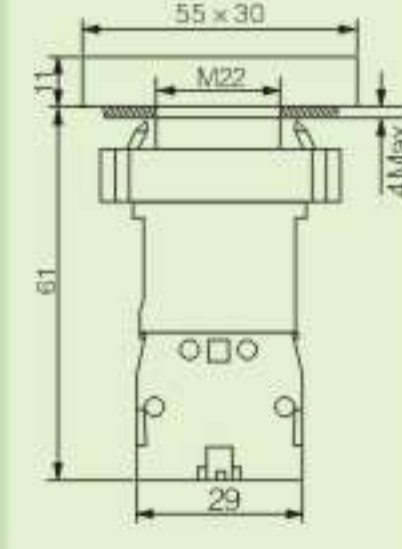
YB2(XB2、LAY5) 系列按钮
YB2(XB2、LAY5) Push button series

按钮 Push button	说明 Description	触点类型 Contact type	电路 Circuit	颜色 Color	型号 Type	外形尺寸 Dimensions
	双头带灯按钮 1 flush green button 1 flush red button Unmarked IP40 with pilot light yellow lens direct supply Max 380V BA9S bulb Neon (BA9S)	N/O + N/C		■ Red □ Yellow/White ■ Green	YB2-BW8365	
	1 flush green button 1 convex red button Marked IP40 Neon (BA9S) LED	N/O + N/C		■ Red □ Yellow/White ■ Green	YB2-BW8465	
	电容式 双头带灯按钮 1 flush green button 1 flush red button Unmarked with pilot light yellow lens direct supply Max 380V BA9S LED 24V bulb With resistance	N/O + N/C		■ Red □ Yellow/White ■ Green	YB2-BW8375	
	1 convex red button 1 flush green button Marked IP40	N/O + N/C		■ Red □ Yellow/White ■ Green	YB2-BW8475	
	双头带灯 带变压器按钮 1 flush green button 1 flush red button Unmarked with pilot light yellow lens direct supply 220~240V BA9S 6V bulb With resistance	N/O + N/C		■ Red □ Yellow/White ■ Green	YB2-BW8345	
	1 convex red button 1 flush green button Marked IP40	N/O + N/C		■ Red □ Yellow/White ■ Green	YB2-BW8445	

YB2(XB2、LAY5) 系列按钮
YB2(XB2、LAY5) Push button series

主令开关 Wobblestick	说明 Description	触点类型 Contact type	电路 Circuit	颜色 Color	型号 Type	外形尺寸 Dimensions
	2位 Position 锁定 Locked	2NO			YB2-PA12	
	2位 Position 弹簧复位 Spring reset	2NO			YB2-PA22	
	2位 Position 锁定 Locked	4NO			YB2-PA14	
	2位 Position 弹簧复位 Spring reset	4NO			YB2-PA24	

安装面板厚度: 1~6mm



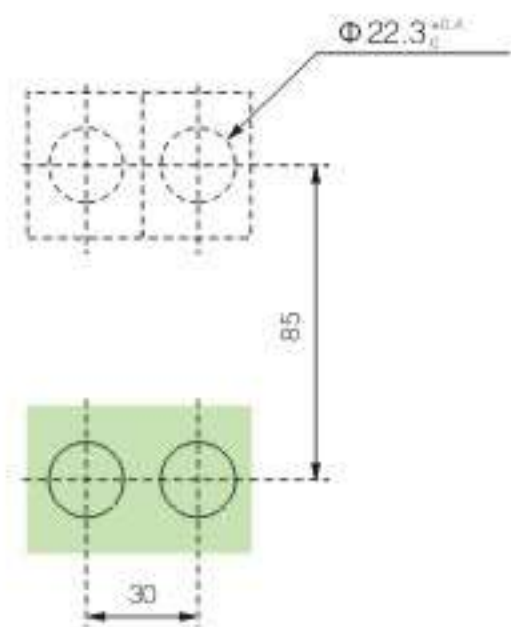



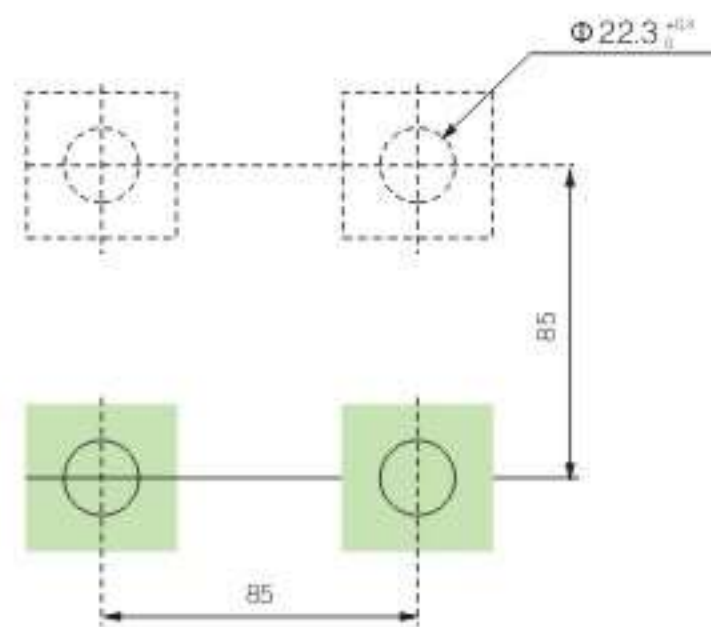





2位(2 Position)



4位(4 Position)



YB2(XB2、LAY5) 系列按钮
YB2(XB2、LAY5) Push button series

按钮 Push buttons	说明 Description	颜色 Color	型号 Type	按钮 Push buttons	说明 Description	颜色 Color	型号 Type
	平头按钮头 Flush button head	○ White ● Black ● Green ● Red ● Yellow ● Blue	YB2-EA1 YB2-EA2 YB2-EA3 YB2-EA4 YB2-EA5 YB2-EA6		标准选择开关头 Standard handle selector switch head 2-positions stay put 3-positions stay put 2-positions spring return 3-positions spring return	▽ ▽ ▽ ▽ ▽ ▽	YB2-ED2 YB2-ED3 YB2-ED4 YB2-ED5 YB2-ED7 YB2-ED8
	平头按钮头 Flush button head Marked	● Green ● Green ⊙ White ● Black ● Red ● Red	YB2-EA331 YB2-EA336 YB2-EA334 YB2-EA335 YB2-EA432 YB2-EA434		长柄选择开关头 Long handle selector switch head 2-positions stay put 3-positions stay put 2-positions spring return 3-positions spring return	▽ ▽ ▽ ▽ ▽ ▽	YB2-EJ2 YB2-EJ3 YB2-EJ4 YB2-EJ5 YB2-EJ7 YB2-EJ8
	凸头按钮头 Convex button head	● Black ● Green ● Red ● Yellow ● Blue	YB2-EL2 YB2-EL3 YB2-EL4 YB2-EL5 YB2-EL6		钥匙开关头 Key switch head 2-positions stay put 2-positions spring return	▽ ▽ ▽	YB2-EG2 YB2-EG4 YB2-EG6
	凸头按钮头 Convex button head Marked	● Green ● Green ⊙ White ● Black ● Red ● Red	YB2-EL331 YB2-EL336 YB2-EL334 YB2-EL335 YB2-EL432 YB2-EL434		钥匙开关头 Key switch head 3-positions stay put 3-positions spring return to centre from left or right	▽ ▽ ▽ ▽ ▽ ▽ ▽ ▽	YB2-EG0 YB2-EG1 YB2-EG3 YB2-EG5 YB2-EG7 YB2-EG8 YB2-EG9 YB2-EG09
	带罩按钮头 Flush button head (with water-proof cover) Unmarked	● Black ● Green ● Red ● Yellow ● Blue	YB2-EP2 YB2-EP3 YB2-EP4 YB2-EP5 YB2-EP6		钥匙蘑菇头 Mushroom head return to release by key	● Black Φ40 ● Red Φ40 ● Red Φ40 ● Red Φ40	YB2-ES12 YB2-ES14 YB2-ES74 YB2-ES24
	指示灯头 Pilot light head	○ White ● Green ● Red ● Yellow ● Blue	YB2-EV01 YB2-EV03 YB2-EV04 YB2-EV05 YB2-EV06		推拉蘑菇头 Mushroom head Push-pull	○ Black Φ40 ● Red Φ40	YB2-ET2 YB2-ET4

YB2(XB2、LAY5) 系列按钮
YB2(XB2、LAY5) Push button series

按钮 Push buttons	说明 Description	颜色 Color	型号 Type
	蘑菇头 Mushroom head Spring return	● Black Φ30	YB2-EC24
		● Green Φ30	YB2-EC34
		● Red Φ30	YB2-EC44
		● Black Φ40	YB2-EC2
		● Green Φ40	YB2-EC3
		● Red Φ40	YB2-EC4
YB2-ER4	蘑菇头 Mushroom head Spring return	● Black Φ60 ● Green Φ60 ● Red Φ60	YB2-ER2 YB2-ER3 YB2-ER4
YB2-ES44	自锁蘑菇头 Mushroom head Spring return	● Black Φ30 ● Red Φ30	YB2-ES42 YB2-ES44
YB2-ES54	自锁蘑菇头 Mushroom head Spring return	● Black Φ40 ● Red Φ40	YB2-ES52 YB2-ES54
YB2-ES64	自锁蘑菇头 Mushroom head Spring return	● Black Φ60 ● Red Φ60	YB2-ES62 YB2-ES64
YB2-EW34	带灯按钮头 Push button with light head	○ White ● Green ● Red ● Yellow ● Blue	YB2-EW31 YB2-EW33 YB2-EW34 YB2-EW35 YB2-EW36

按钮 Push buttons	说明 Description	颜色 Color	型号 Type
YB2-EL83	双头按钮头 Double-head 1 flush red button 1 flush green button Unmarked	● Green ● Red ○ White ● Green ● Red	YB2-EL83 IP40 YB2-EL93 with water-proof cover IP65
YB2-EL84	双头按钮头 Double-head 1 convex red button 1 flush green button marked	● Green ● Red ○ White ● Green ● Red	YB2-EL84 IP40 YB2-EL94 with water-proof cover IP65
YB2-EW84	双头按钮头 Double-head with lamp 1 convex red button 1 flush green button	● Red ● Yellow ● Green	YB2-EW83 YB2-EW84
YB2-EK23	选择开关头 Selector switch head with lamp 2-positions stay put	● Green ● Red ● Yellow	YB2-EK23 YB2-EK24 YB2-EK25
YB2-EK33	选择开关头 Selector switch head with lamp 3-positions stay put	● Green ● Red ● Yellow	YB2-EK33 YB2-EK34 YB2-EK35
YB2-EU334	平头按钮头 Flush button head IP67	⊕ White ⊖ Black	YB2-EU335 YB2-EU334







YB2(XB2、LAY5) 系列按钮
YB2(XB2、LAY5) Push button series

按钮 Push buttons	说明 Description	颜色 Color	型号 Type
YB2-BA3	平头按钮头 Flush button head	○ White ● Black ● Green ● Red ● Yellow ● Blue	YB2-BA1 YB2-BA2 YB2-BA3 YB2-BA4 YB2-BA5 YB2-BA6
YB2-BA432	平头按钮头 Flush button head Marked	⊕ Green ⊖ Green ⊕ White ⊖ Black ● Red ● Red ● Green	YB2-BA331 YB2-BA336 YB2-BA334 YB2-BA335 YB2-BA432 YB2-BA434 YB2-BA533
YB2-BL4	凸头按钮头 Convex button head	● Black ● Green ● Red ● Yellow ● Blue	YB2-BL2 YB2-BL3 YB2-BL4 YB2-BL5 YB2-BL6
YB2-BL334	凸头按钮头 Convex button head Marked	⊕ Green ⊖ Green ⊕ White ⊖ Black ● Red ● Red	YB2-BL331 YB2-BL336 YB2-BL334 YB2-BL335 YB2-BL432 YB2-BL434
YB2-BP3	带罩按钮头 Flush button head (with water-proof cover) Unmarked	● Black ● Green ● Red ● Yellow ● Blue	YB2-BP2 YB2-BP3 YB2-BP4 YB2-BP5 YB2-BP6
YB2-BV05	指示灯头 Pilot light head	○ White ● Green ● Red ● Yellow ● Blue	YB2-VV01 YB2-VV03 YB2-VV04 YB2-VV05 YB2-VV06









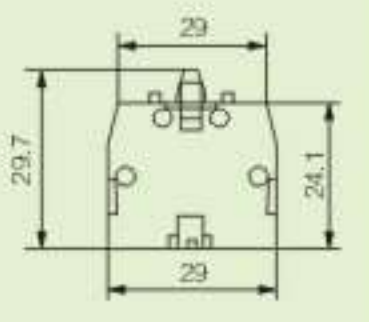

按钮 Push buttons	说明 Description	颜色 Color	型号 Type
YB2-BW33	指示灯头 Pilot light head with higher transparent protecting cover	● Green ● Red ● Yellow ● Blue	YB2-BW33 YB2-BW34 YB2-BW35 YB2-BW36
YB2-BK24	带灯选择开关头 Selector switch head with lamp 2-positions stay put	● Green ● Red ● Yellow	YB2-BK23 YB2-BK24 YB2-BK25
YB2-BK33	带灯选择开关头 Selector switch head with lamp 3-positions stay put	● Green ● Red ● Yellow	YB2-BK33 YB2-BK34 YB2-BK35
YB2-BD2	标准选择开关头 Standard handle selector switch head 2-positions stay put 3-positions stay put 2-positions spring return 3-positions spring return	▽ ▽ ▽ ▽ ▽	YB2-BD2 YB2-BD3 YB2-BD4 YB2-BD5 YB2-BD7 YB2-BD8
YB2-BJ2	长柄选择开关头 Long handle selector switch head 2-positions stay put 3-positions stay put 2-positions spring return 3-positions spring return	▽ ▽ ▽ ▽ ▽	YB2-BJ2 YB2-BJ3 YB2-BJ4 YB2-BJ5 YB2-BJ7 YB2-BJ8
YB2-BG2	钥匙开关头 Key switch head 2-positions stay put 2-positions spring return	▽ ▽ ▽	YB2-BG2 YB2-BG4 YB2-BG6

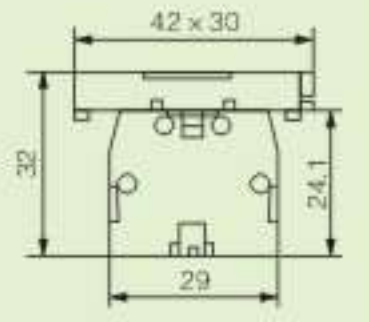
YB2(XB2、LAY5) 系列按钮
YB2(XB2、LAY5) Push button series

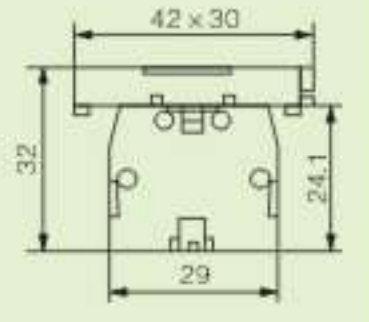
按钮 Push buttons	说明 Description	颜色 Color	型号 Type
	钥匙开关头 Key switch head 3-positions stay put 3-positions spring return		YB2-EG0 YB2-EG1 YB2-EG3 YB2-EG5 YB2-EG7 YB2-EG8 YB2-EG9 YB2-EG09
	蘑菇头 Mushroom head Spring return	● Black Φ30 ● Green Φ30 ● Red Φ30 ● Black Φ40 ● Green Φ40 ● Red Φ40	YB2-BC24 YB2-BC34 YB2-BC44 YB2-BC2 YB2-BC3 YB2-BC4
	蘑菇头 Mushroom head Spring return	● Black Φ60 ● Green Φ60 ● Red Φ60	YB2-BR2 YB2-BR3 YB2-BR4
	自锁蘑菇头 Mushroom head Spring return	● Black Φ30 ● Red Φ30	YB2-BS42 YB2-BS44
	自锁蘑菇头 Mushroom head Spring return	● Black Φ40 ● Red Φ40	YB2-BS52 YB2-BS54
	自锁蘑菇头 Mushroom head Spring return	● Black Φ60 ● Red Φ60	YB2-BS62 YB2-BS64

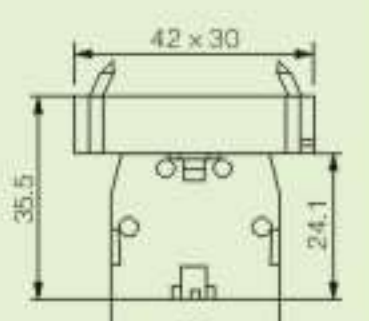
按钮 Push buttons	说明 Description	颜色 Color	型号 Type
	推拉蘑菇头 Mushroom head Push-pull	○ Black Φ40 ● Red Φ40	YB2-BT2 YB2-BT4
	钥匙蘑菇头 Mushroom head return to release by key	● Black Φ40 ● Red Φ40 ● Red Φ40 ● Red Φ40	YB2-ES12 YB2-ES14 YB2-ES74 YB2-ES24
	双头按钮头 Double-head 1 flush red button 1 flush green button Unmarked	■ Green ■ Red ○ White ■ Green ■ Red	YB2-BL83 IP40 YB2-BL93 with water-proof cover IP65
	双头按钮头 Double-head 1 convex red button 1 flush green button marked	■ Green ■ Red ○ White ■ Green ■ Red	YB2-BL84 IP40 YB2-EL94 with water-proof cover IP65
	双头按钮头 Double-head with lamp 1 convex red button 1 flush green button	■ Red ■ Yellow ■ Green	YB2-BW83
	双头按钮头 Double-head with lamp 1 convex red button 1 flush green button	■ Red ■ Yellow ■ Green	YB2-BW84

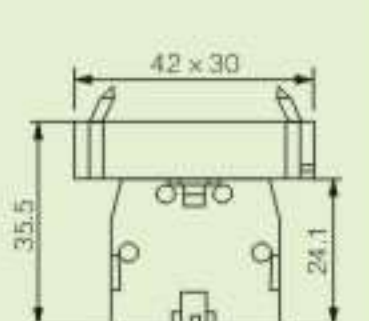

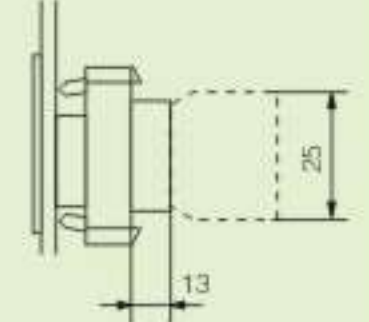





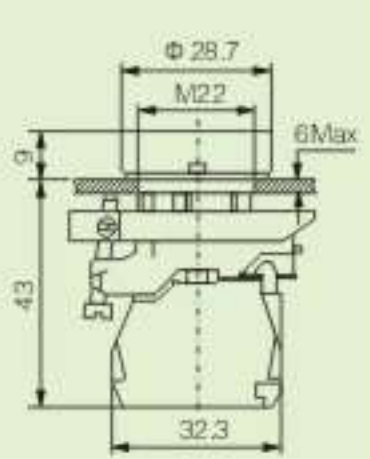

YB2(XB2、LAY5) 系列按钮
YB2(XB2、LAY5) Push button series

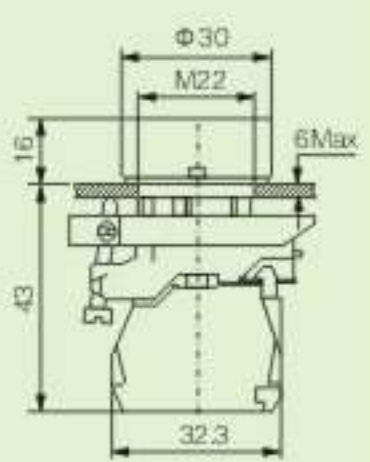
按钮 Push button	说明 Description	触点类型 Contact type	电路 Circuit	颜色 Color	型号 Type	外形尺寸 Dimensions
	接触模块 Contact element	N/O N/C	3 4 1 2	● Green ● Red	YB2-BE101 YB2-BE102	
	塑料托槽 接触模块 Plastic bracket+ Contact element	N/O N/O+N/O N/C+N/C	3 4 3 4 3 4 1 2	● Green ● Red	YB2-BZ101 YB2-BZ103 YB2-BZ105	
	金属托槽 接触模块 Metal bracket+ Contact element	N/O N/C+N/C	1 2 1 2	● Red	YB2-BZ102 YB2-BZ104	
	金属托槽 接触模块 Metal bracket+ Contact element	N/O N/O+N/O N/C+N/C	3 4 3 4 3 4 1 2	● Green ● Red	YB2-BZ101 YB2-BZ103 YB2-BZ105	
	金属托槽 接触模块 Metal bracket+ Contact element	N/O N/C+N/C	1 2 1 2	● Red	YB2-BZ102 YB2-BZ104	
	用于按钮(除急停按钮、选择、钥匙开关外)和带灯按钮安装于触点模块前面,实现按-锁定-按-释放 For use with pushbuttons and illuminated pushbuttons contacts max				YB2-BZ21C	

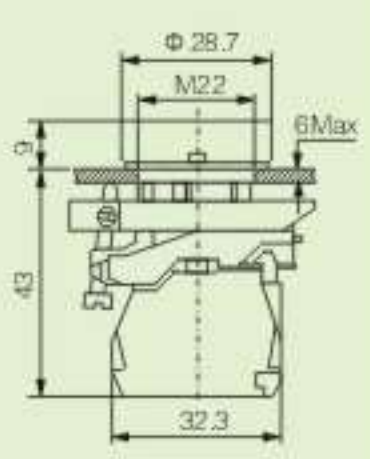

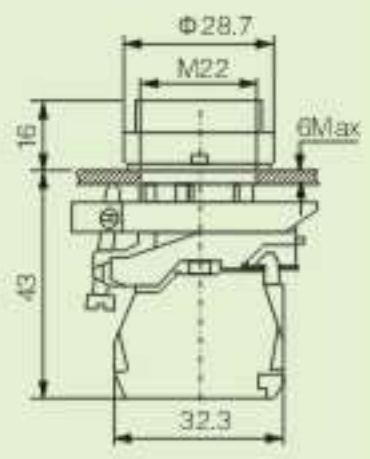

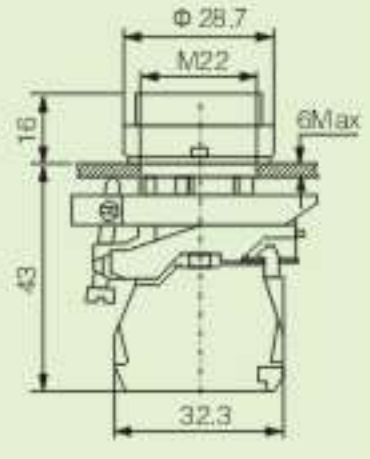

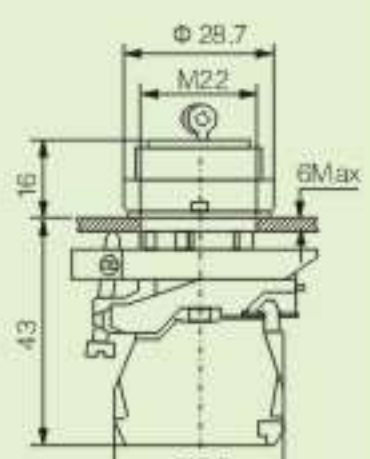

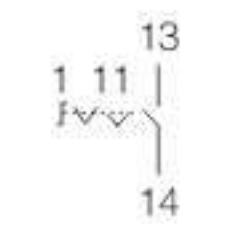
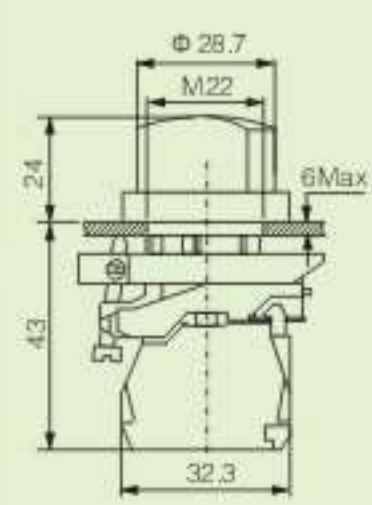
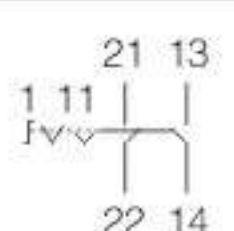

YB2(XB2、LAY5) 系列按钮
YB2(XB2、LAY5) Push button series

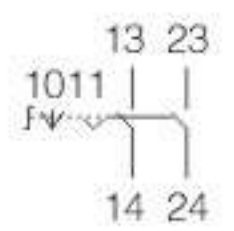
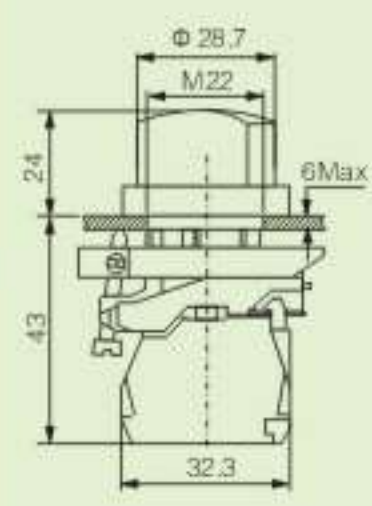
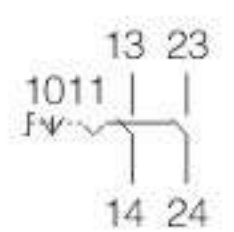
按钮 Push buttons	说明 Description	型号 Type	按钮 Push buttons	说明 Description	型号 Type
	按钮座 Button seat of button with lamp Direct type Neon LED(BA9S)	YB2-EV06 (without push-shaft) YB2-EW06 (with push- shaft)		按钮座 Button seat of button with lamp Direct type Neon LED(BA9S)	YB2-BV06 (without push-shaft) YB2-BW06 (with push- shaft)
	按钮座 Button seat of button with lamp Direct type Neon LED (BA9S) (Assembly contact element)	YB2-EW06 N/O YB2-EW061 N/C YB2-EW062 N/O+N/O YB2-EW063 N/C+N/C YB2-EW064 N/C+N/C YB2-EW065		按钮座 Button seat of button with lamp Direct type Neon LED (BA9S) (Assembly contact element)	YB2-BW06 N/O YB2-BW061 N/C YB2-BW062 N/O+N/O YB2-BW063 N/C+N/C YB2-BW064 N/C+N/C YB2-BW065
	按钮座 Button seat of button with lamp install base BA9S resistance ≤250V Neon LED(BA9S)	YB2-EW7 Without contact element YB2-EW071 N/O YB2-EW072 N/C YB2-EW073 N/O+N/O YB2-EW074 N/C+N/C YB2-EW075 N/C+N/C With contact element		按钮座 Button seat of button with lamp install base BA9S resistance ≤250V Neon LED(BA9S)	YB2-BW7 Without contact element YB2-BW071 N/O YB2-BW072 N/C YB2-BW073 N/O+N/O YB2-BW074 N/C+N/C YB2-BW075 N/C+N/C With contact element
	按钮座 Button seat of button with lamp Install base BA9S resistance ≤250V Neon LED(BA9S)	YB2-EW4 Without contact element YB2-EW041 N/O YB2-EW042 N/C YB2-EW043 N/O+N/O YB2-EW044 N/C+N/C YB2-EW045 N/C+N/C With contact element		按钮座 Button seat of button with lamp Install base BA9S resistance ≤250V Neon LED(BA9S)	YB2-BW3 Without contact element YB2-BW031 N/O YB2-BW032 N/C YB2-BW033 N/O+N/O YB2-BW034 N/C+N/C YB2-BW035 N/C+N/C With contact element
	按钮座 Button seat of button with lamp install base BA9S resistance ≤380V Neon LED(BA9S)	YB2-EW5 Without contact element YB2-EW051 N/O YB2-EW052 N/C YB2-EW053 N/O+N/O YB2-EW054 N/C+N/C YB2-EW055 N/C+N/C With contact element		按钮座 Button seat of button with lamp install base BA9S resistance ≤380V Neon LED(BA9S)	YB2-BW4 Without contact element YB2-BW041 N/O YB2-BW042 N/C YB2-BW043 N/O+N/O YB2-BW044 N/C+N/C YB2-BW045 N/C+N/C With contact element

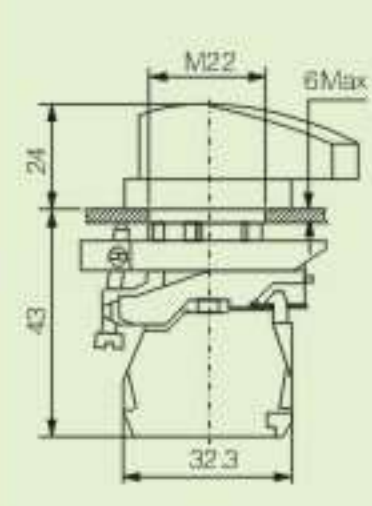
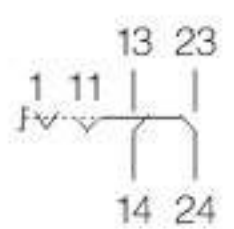

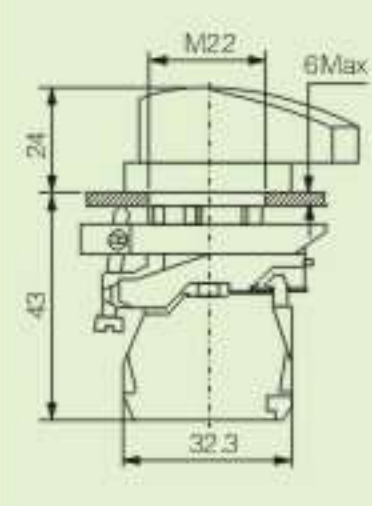
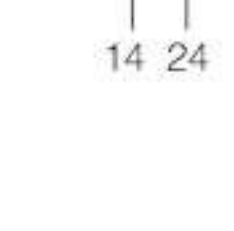

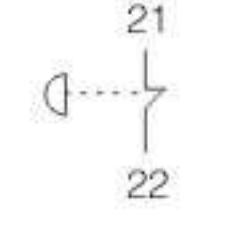
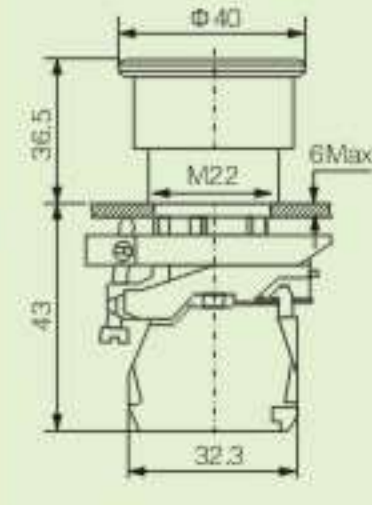

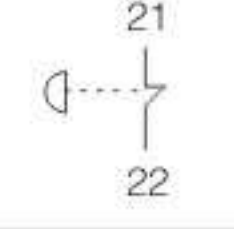
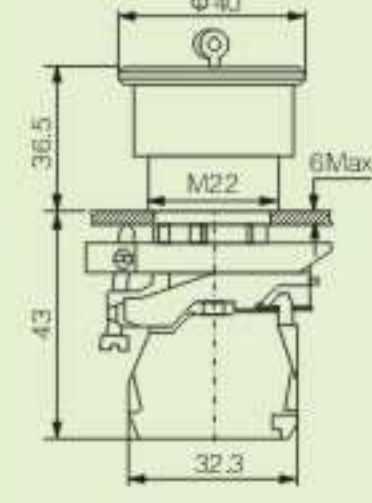
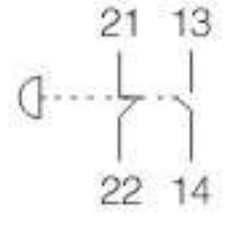

YB4 系列按钮
YB4 Push button series

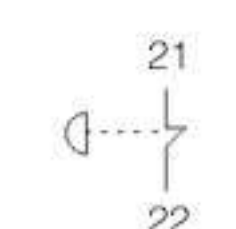
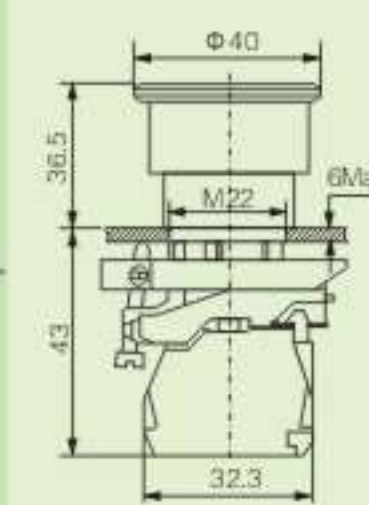
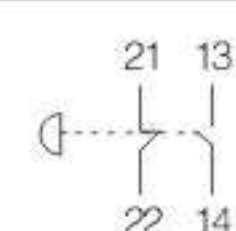
按钮 Push button	说明 Description	触点类型 Contact type	电路 Circuit	颜色 Color	型号 Type	外形尺寸 Dimensions
	平钮 Flush button Spring return	N/O	13 14	○ White ● Black ● Green ● Blue ● Yellow	YB4-BA11 YB4-BA21 YB4-BA31 YB4-BA61 YB4-BA51	
		N/C	21 22	● Red Φ40	YB4-BA42	
	带防护罩高钮 防护等级IP65 Flush button (with water-proof cover) Unmarked IP65	N/O	13 14	○ White ● Black ● Green ● Blue ● Yellow	YB4-BP11 YB4-BP21 YB4-BP31 YB4-BP61 YB4-BP51	
		N/C	21 22	● Red Φ40	YB4-BP42	
	带标记平钮 Flush button Spring return Marked	N/O	13 14	● Green ● Green ⊕ White ⊖ Black	YB4-BA3311 YB4-BA3361 YB4-BA3341 YB4-BA3351	
		N/C	21 22	● Red ● Red	YB4-BA4322 YB4-BA4342	
	带标记凸钮 Convex button Spring return Marked	N/O	13 14	● Green ● Green ⊕ White ⊖ Black	YB4-BL3311 YB4-BL3361 YB4-BL3341 YB4-BL3351	
		N/C	21 22	● Red ● Red	YB4-BL4322 YB4-BL4342	
	凸钮 Convex button Spring return Unmarked	N/O	13 14	● Black ● Green ● Blue ● Yellow	YB4-BL21 YB4-BL31 YB4-BL61 YB4-BL51	
		N/C	21 22	● Red Φ40	YB4-BL42	
	LH Position	N/O	13 14	2位钥匙锁定 2 Position stay put 2位钥匙自复 2 Position spring return	YB4-BG21 YB4-BG41	
	LH and RH Position	N/O+N/C	21 13 22 14	2位钥匙锁定 2 Position stay put 2位钥匙自复 2 Position spring return	YB4-BG25 YB4-BG45	
	Center Position	N/O+N/O	1011 13 23 14 24	3位钥匙锁定 3 Position stay put 3位钥匙自复 3 Position spring return	YB4-BG33 YB4-BG73	

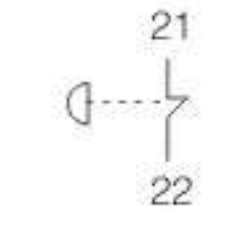
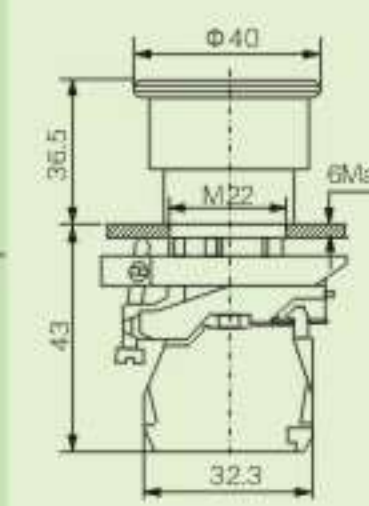
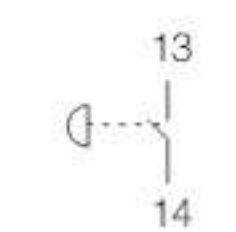

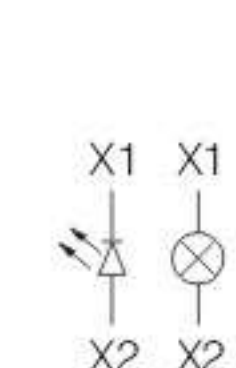
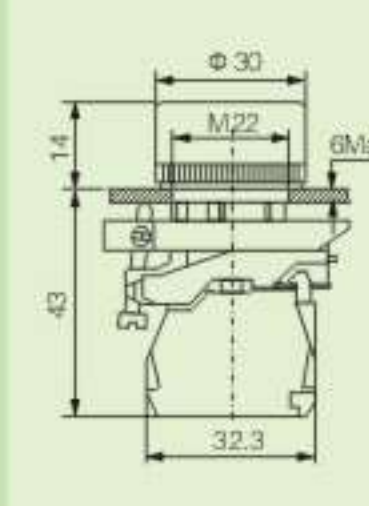

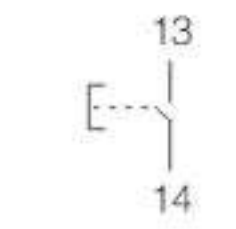
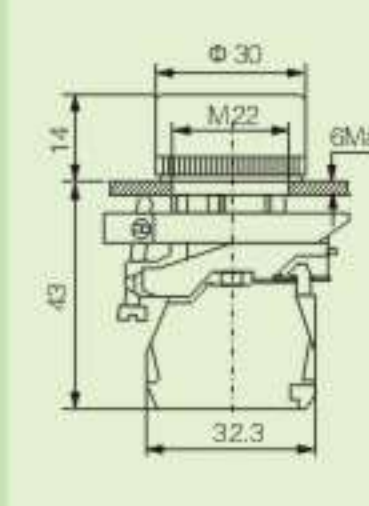
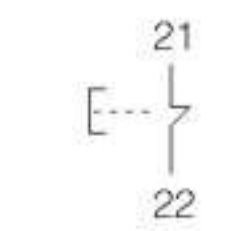

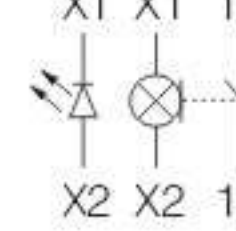
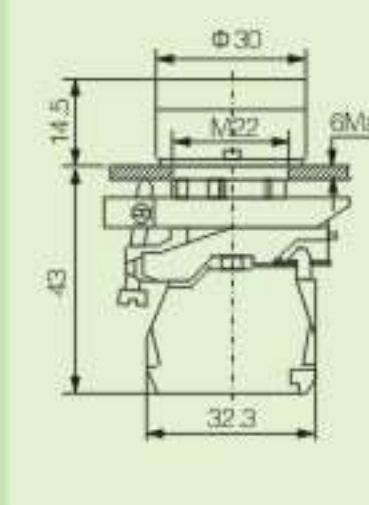
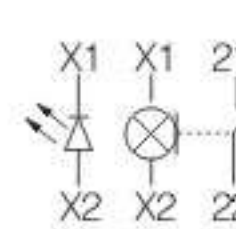

YB4系列按钮
YB4 Push button series

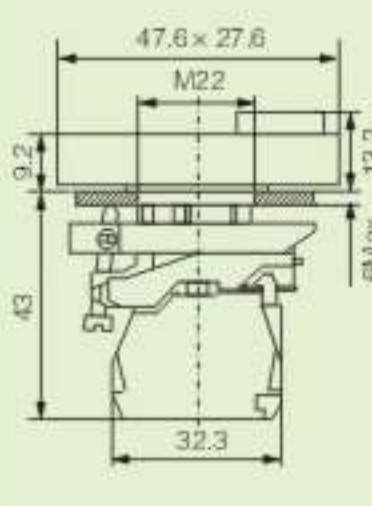
按钮 Push button	说明 Description	触点类型 Contact type	电路 Circuit	颜色 Color	型号 Type	外形尺寸 Dimensions
 YB4-BD21	标准手柄 Standard handle	N/O		2位自复 2 Position stay put	YB4-BD21	
		N/O+N/C		2位自锁 2 Position spring return	YB4-BD41	
 YB4-BD33	标准手柄 Standard handle	N/O+N/O		2位自锁 2 Position stay put	YB4-BD33	
		N/O+N/O		3位自复 3 Position spring return	YB4-BD53	
 YB4-BJ41	长手柄 Long handle	N/O		2位自锁 2 Position stay put	YB4-BJ21	
		N/O+N/C		2位自复 2 Position spring return	YB4-BJ41	
 YB4-BJ53	长手柄 Long handle	N/O+N/O		2位自锁 2 Position stay put	YB4-BJ25	
		N/O+N/O		3位自复 3 Position spring return	YB4-BJ53	
 YB4-BT42	蘑菇头推拉式 Push-pull	N/C		● Red Φ40	YB4-BT42	
		N/O+N/C		● Red Φ40	YB4-BT45	
 YB4-BS142	蘑菇头自锁 钥匙复位 Tum to release by key (Key n° 445)	N/C		● Red Φ40	YB4-BS142	
		N/O+N/C		● Red Φ40	YB4-BS145	

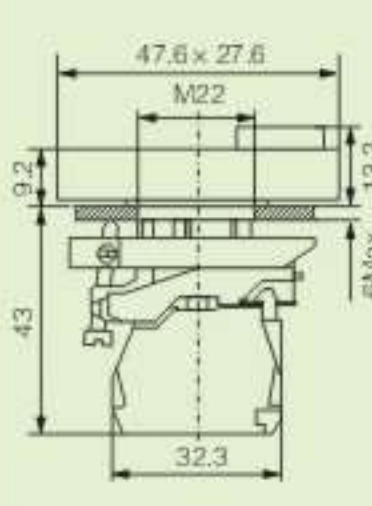

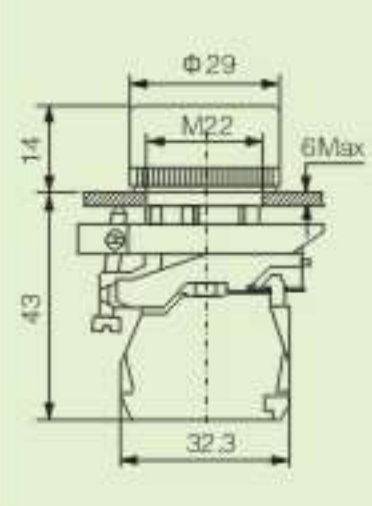

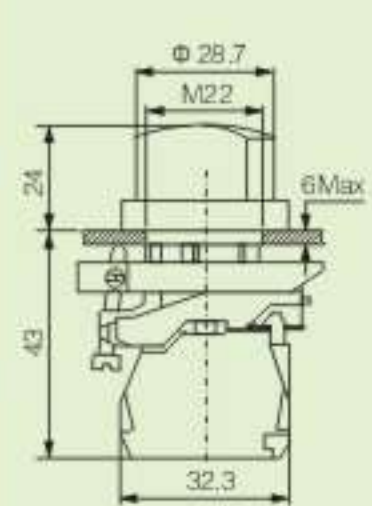

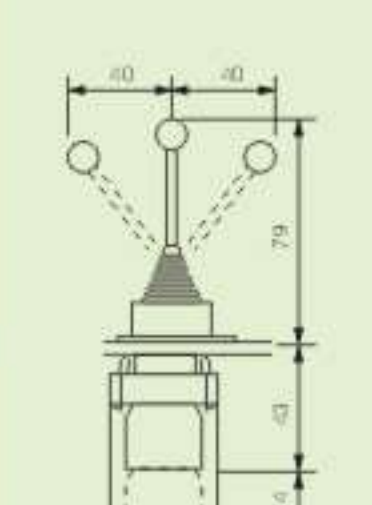









YB4系列按钮
YB4 Push button series

按钮 Push button	说明 Description	触点类型 Contact type	电路 Circuit	颜色 Color	型号 Type	外形尺寸 Dimensions
 YB4-BS542	蘑菇头自锁 Turn to release	N/O		● Red Φ40	YB4-BS542	
		N/O+N/C		● Red Φ40	YB4-BS545	
 YB4-BC42	蘑菇头自复 Mushroom head Spring return	N/C		● Red Φ40	YB4-BC42	
		N/O		● Black Φ40 ● Green Φ40	YB4-BC21 YB4-BC31	
 YB4-BV64	带指示灯按钮 Direct bulb included BA9S base fitting Neon LED (BA9S)	130V 220~240V 50Hz		○ White ● Green ● Red ● Yellow ● Blue	YB4-BV61 YB4-BV63 YB4-BV64 YB4-BV65 YB4-BV66	
		N/O + N/C		○ White [7] ● Green [3] ● Red [4] ● Yellow [5] ● Blue [6] B-24V G-110V M-220V	YB4-BVB□ YB4-BVB□ YB4-BVB□ YB4-BVG□ YB4-BVG□ YB4-BVG□ YB4-BVM□ YB4-BVM□ YB4-BVM□	
 YB4-BW3361	带指示灯按钮 Direct bulb supplied Neon LED (BA9S)	N/O		○ White ● Green ● Yellow ● Blue	YB4-BW3161 YB4-BW3361 YB4-BW3561 YB4-BW3661	
		N/C		● Red	YB4-BW3462	
 YB4-BL8325	双头按钮(不带灯) 1 flush green button 1 flush red button Unmarked Without pilot light IP40	N/O+N/C		■ Green ■ Red	YB4-BL8325	
		N/O+N/C		■ Green ■ Red	YB4-BL8425	









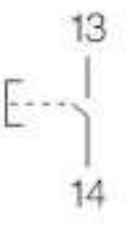
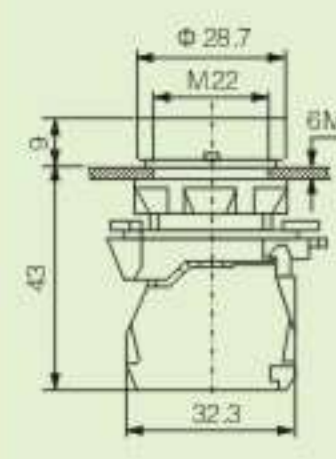

YB4系列按钮 YB4 Push button series

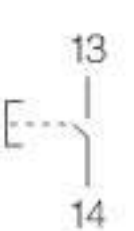
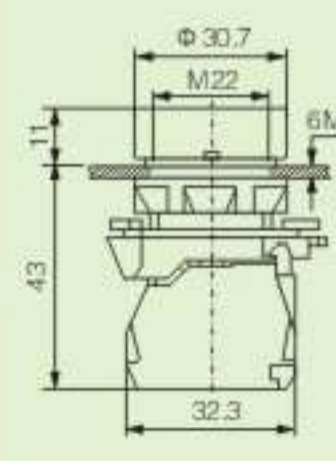
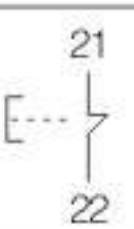
按钮 Push button	说明 Description	触点类型 Contact type	电路 Circuit	颜色 Color	型号 Type	外形尺寸 Dimensions
	双头防水按钮 Without pilot light 1 flush green button 1 flush red button (with water-proof cover) marked IP66	N/O +	13 14	○ White ■ Green ■ Red	YB4-BL9325	
YB4-BL9325		N/C	21 22	○ White ■ Green ■ Red	YB4-BL9425	
	双头带灯按钮 Pilot light with yellow lens direct supply 220~240V BA9S bulb marked IP40 Neon LED (BA9S)	N/O +	13 14	■ Red ■ Yellow ■ Green	YB4-BW8365 YB4-BW83B5 YB4-BW83G5 YB4-BW83M5	
YB4-BW8465		N/C	21 22	B-24V G-110V M-220V	YB4-BW8465 YB4-BW84B5 YB4-BW84G5 YB4-BW84M5	
	带灯按钮 Push button with lamp	N/O +	13 14	○ White ■ Green ■ Red ■ Yellow ■ Blue	YB4-BW33B5 YB4-BW34B5 YB4-BW35B5 YB4-BW33G5 YB4-BW34G5 YB4-BW35G5	
YB4-BW33M5		N/C	21 22	B-24V G-110V M-220V	YB4-BW33M5 YB4-BW34M5 YB4-BW35M5	
	二位旋钮带灯24V 2 Position stay put	N/O +	21 13 10 11	■ Green ■ Red ■ Yellow	YB4-BK123B5 YB4-BK124B5 YB4-BK125B5	
YB4-BK124B5	三位旋钮带灯110V 3 Position stay put	N/O +	21 13 10 11	■ Green ■ Red ■ Yellow	YB4-BK133G5 YB4-BK134G5 YB4-BK135G5	
	三位旋钮带灯220V 3 Position stay put	N/C	22 14	■ Green ■ Red ■ Yellow	YB4-BK153M5 YB4-BK154M5 YB4-BK155M5	
	2位 2 Position	N/O	① → ②		YB4-PA12 YB4-PA22	
YB4-PA12	4位 4 Position		① → ② ③ → ④		YB4-PA14 YB4-PA24	

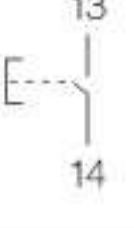
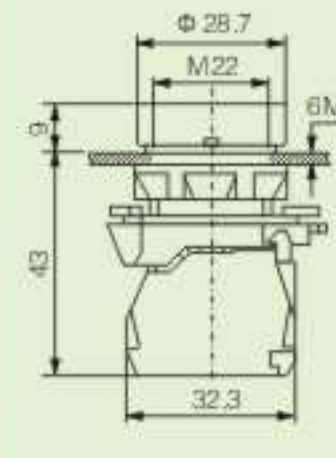
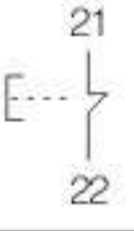

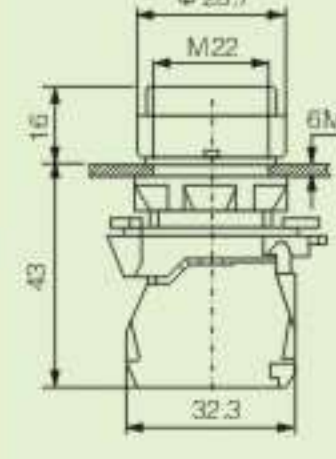
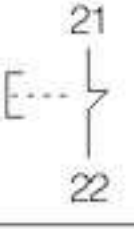

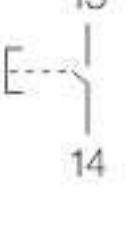
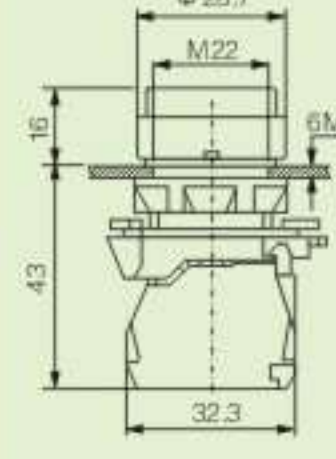
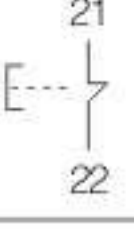

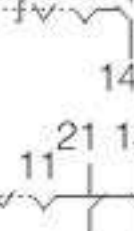
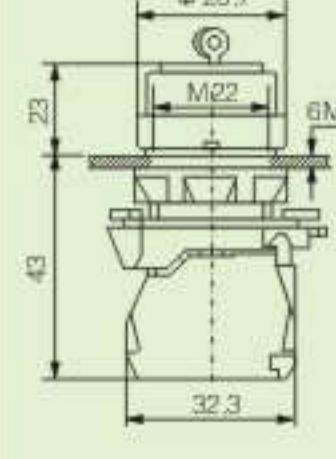
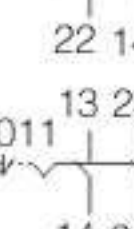
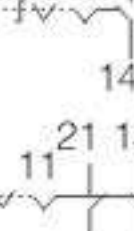
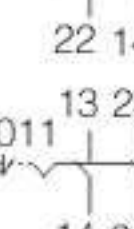
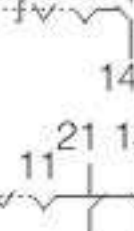
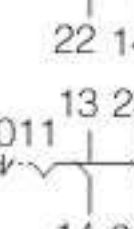



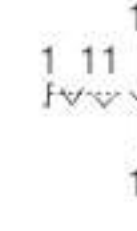
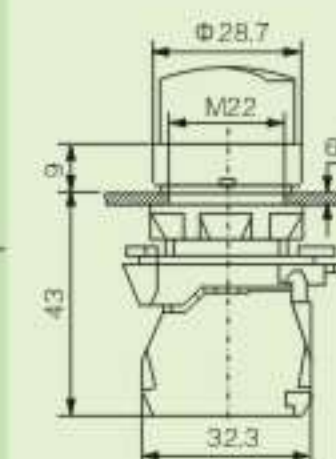
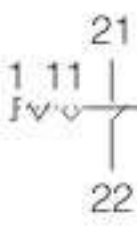

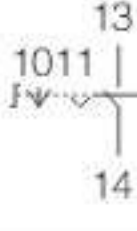
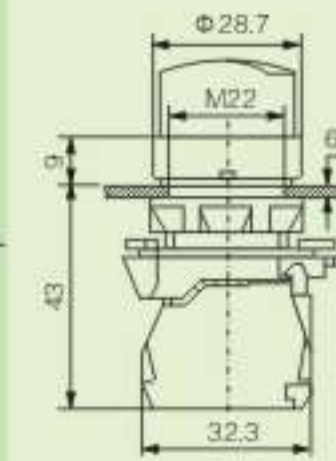
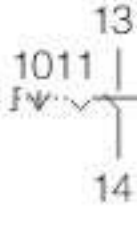

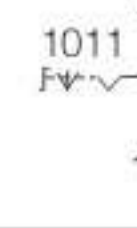
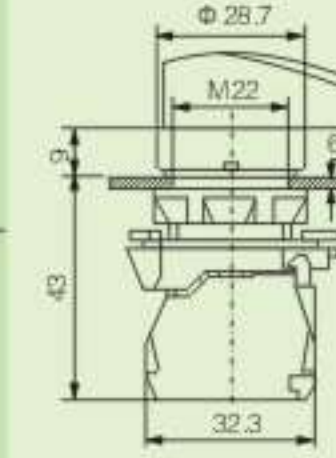
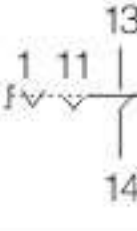
YB4系列按钮 YB4 Push button series

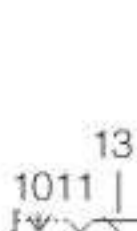
按钮 Push buttons	说明 Description	颜色 Color	型号 Type	按钮 Push buttons	说明 Description	颜色 Color	型号 Type
	平头按钮头 Flush button head	● Black ● Green ● Red ● Yellow ● Blue	YB4-BA2 YB4-BA3 YB4-BA4 YB4-BA5 YB4-BA6		2-positions stay put spring return 3-positions stay put 3-positions spring return	● Black	YB4-BD2 YB4-BD3 YB4-BD4 YB4-BD5
YB4-BA3		● Green ● Green ⊙ White ● Black ● Red ● Red	YB4-BA331 YB4-BA336 YB4-BA334 YB4-BA335 YB4-BA432 YB4-BA434		2-positions stay put 3-positions stay put 2-positions spring return 3-positions spring return	● Black	YB4-BJ2 YB4-BJ3 YB4-BJ4 YB4-BJ5
	平头按钮头 Flush button head Marked	● Green ● Green ⊙ White ● Black ● Red ● Red			2-positions stay put 2-positions spring return 3-positions stay put 3-positions spring return		YB4-BG2 YB4-BG3 YB4-BG4 YB4-BG7
YB4-BA432		● Black ● Green ● Red ● Yellow ● Blue	YB4-BL2 YB4-BL3 YB4-BL4 YB4-BL5 YB4-BL6		Mushroom head return to release by key	● Black Φ40 ● Red Φ40	YB4-BS12 YB4-BS14
	凸头按钮头 Convex button head	● Green ● Green ⊙ White ● Black ● Red ● Red	YB4-BL331 YB4-BL336 YB4-BL334 YB4-BL335 YB4-BL432 YB4-BL434		Return to release by Push put spring return	● Red Φ40 ● Red Φ40 ● Black Φ40 ● Green Φ40 ● Red Φ40	YB4-BS54 YB4-BT54 YB4-BC2 YB4-BC3 YB4-BC4
YB4-BL4		● Black ● Green ● Red ● Yellow ● Blue	YB4-BP2 YB4-BP3 YB4-BP4 YB4-BP5 YB4-BP6		1 flush green 1 flush red Unmarked	■ Green ■ Red	YB4-BL83
	凸头按钮头 Convex button head Marked	● Green ● Green ⊙ White ● Black ● Red ● Red			1 flush green 1 convex red Marked	■ Green ■ Red	YB4-BL84
YB4-BL432		● Black ● Green ● Red ● Yellow ● Blue	YB4-BV03 YB4-BV04 YB4-BV05 YB4-BV06		Lamp-head 1 flush green 1 flush red Unmarked	■ Red ■ Yellow ■ Green	YB4-BW83
	带罩按钮头 Flush button head (with water-proof cover) Unmarked	● Black ● Green ● Red ● Yellow ● Blue	YB4-BW33 YB4-BW34 YB4-BW35 YB4-BW36		Lamp-head 1 flush green 1 convex red Marked	■ Red ■ Yellow ■ Green	YB4-BW84
YB4-BP3		● Green ● Red ● Yellow ● Blue					
	指示灯头 Pilot light head	● Green ● Red ● Yellow ● Blue					
YB4-BV03		● Green ● Red ● Yellow ● Blue					
	指示灯头 Pilot light head, the button is flush	● Green ● Red ● Yellow ● Blue					
YB4-BW33							



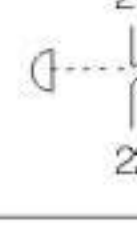



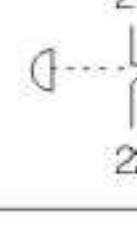
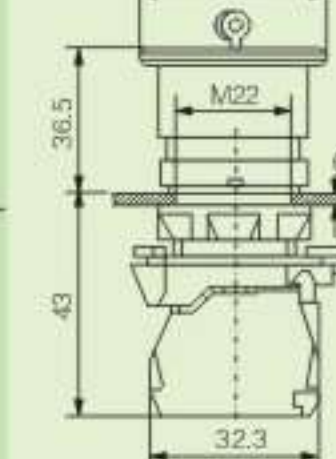
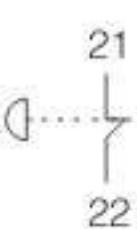

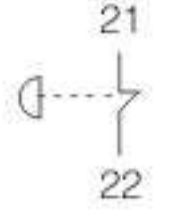
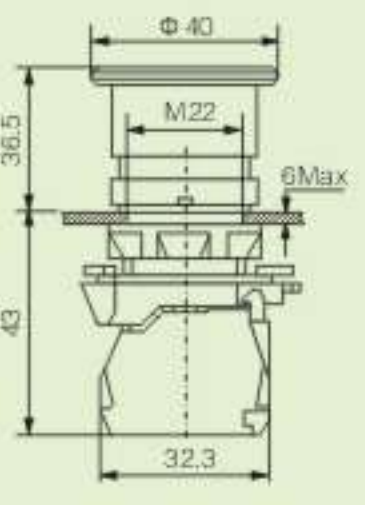
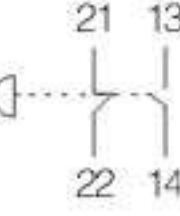

YB5系列按钮
YB5 Push button series

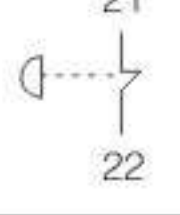
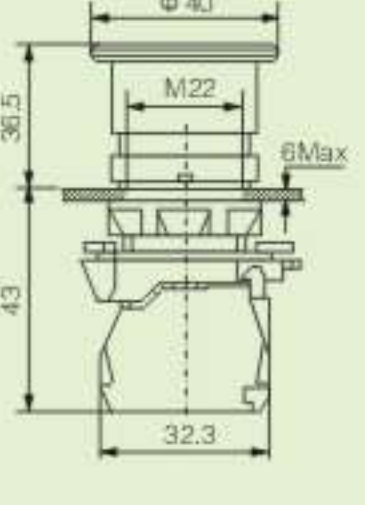
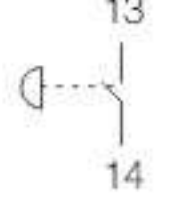
按钮 Push button	说明 Description	触点类型 Contact type	电路 Circuit	颜色 Color	型号 Type	外形尺寸 Dimensions
	平钮 Flush button Spring return	N/O		● Black ● Green ● Blue ● Yellow	YB5-AA21 YB5-AA31 YB5-AA61 YB5-AA51	
		N/C		● Red $\Phi 40$	YB5-AA42	
	带防护罩高钮 防护等级IP65 Flush button (with water-proof cover) Unmarked IP65	N/O		○ White ● Black ● Green ● Blue ● Yellow	YB5-AP11 YB5-AP21 YB5-AP31 YB5-AP61 YB5-AP51	
		N/C		● Red $\Phi 40$	YB5-AP42	
	带标记平钮 Flush button Spring return Marked	N/O		● Green ● Green ⊕ White ● Black	YB5-AA3311 YB5-AA3361 YB5-AA3341 YB5-AA3351	
		N/C		● Red ● Red	YB5-AA4322 YB5-AA4342	
	带标记凸钮 Convex button Spring return Marked	N/O		● Green ● Green ⊕ White ● Black	YB5-AL3311 YB5-AL3361 YB5-AL3341 YB5-AL3351	
		N/C		● Red ● Red	YB5-AL4322 YB5-AL4342	
	凸钮 Convex button Spring return Unmarked	N/O		● Black ● Green ● Blue ● Yellow	YB5-AL21 YB5-AL31 YB5-AL61 YB5-AL51	
		N/C		● Red $\Phi 40$	YB5-AL42	
	LH Position	N/O			YB5-AG21	
					YB5-AG41	
	LH and RH Position	N/O+N/C			YB5-AG25	
					YB5-AG45	
	Center Position	N/O+N/O			YB5-AG33	
					YB5-AG73	

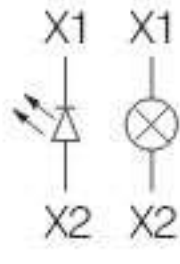
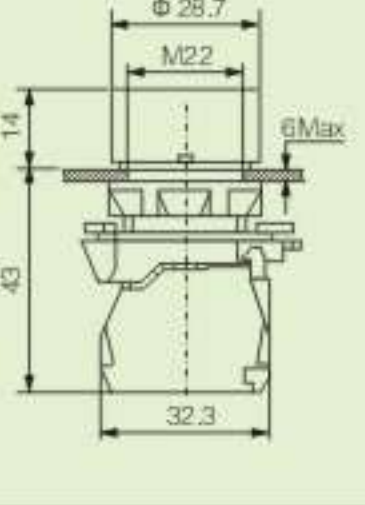

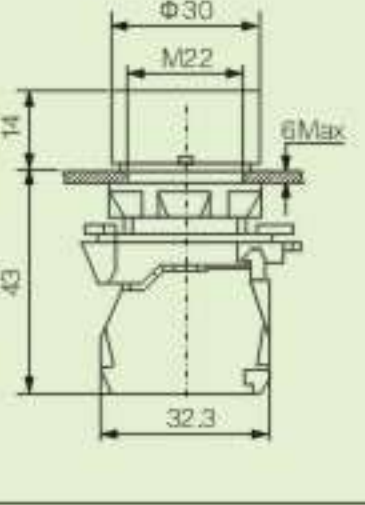

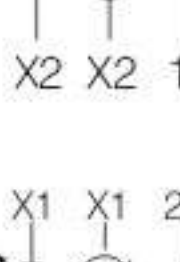
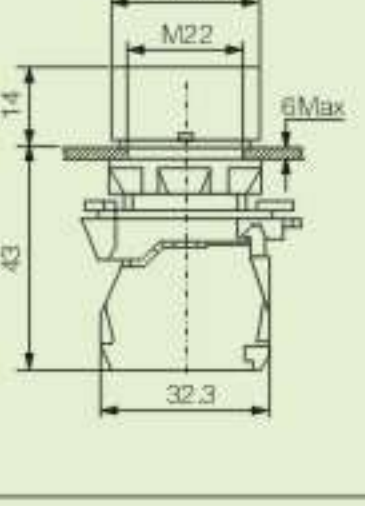
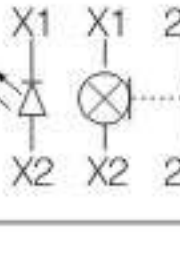

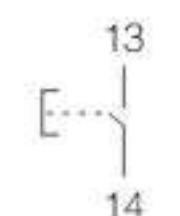
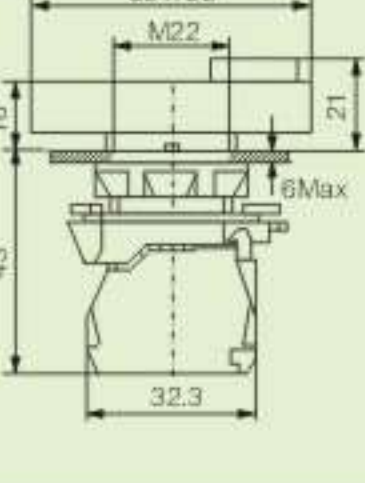



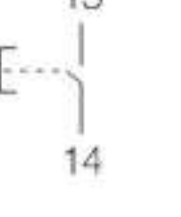

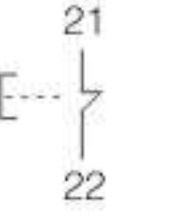

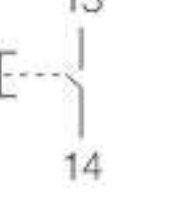
YB5系列按钮
YB5 Push button series

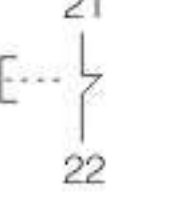
按钮 Push button	说明 Description	触点类型 Contact type	电路 Circuit	颜色 Color	型号 Type	外形尺寸 Dimensions
	标准手柄 Standard handle	N/O		2位自复 2 Position stay put	YB5-AD21	
		N/O+N/C		2位自锁 2 Position spring return	YB5-AD41	
	标准手柄 Standard handle	N/O+N/O		3位自锁 3 Position stay put	YB5-AD33	
		N/O+N/O		3位自复 3 Position spring return	YB5-AD53	
	长手柄 Long handle	N/O		2位自锁 2 Position stay put	YB5-AJ21	
		N/O+N/C		2位自复 2 Position spring return	YB5-AJ41	
	长手柄 Long handle	N/O+N/O		3位自锁 3 Position stay put	YB5-AJ33	
		N/O+N/O		3位自复 3 Position spring return	YB5-AJ53	
	蘑菇头推拉式 Push-pull	N/C		● Red $\Phi 40$	YB5-AT42	
		N/O+N/C		● Red $\Phi 40$	YB5-AT45	
	蘑菇头自锁 钥匙复位 Turn to release by key (Key n° 445)	N/C		● Red $\Phi 40$	YB5-AS142	
		N/O+N/C		● Red $\Phi 40$	YB5-AS145	

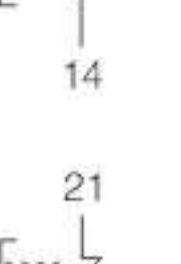
YB5系列按钮
YB5 Push button series

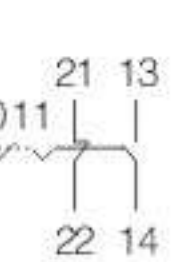
按钮 Push button	说明 Description	触点类型 Contact type	电路 Circuit	颜色 Color	型号 Type	外形尺寸 Dimensions
 YB5-AS542	蘑菇钮自锁 Turn to release	N/O		Red $\Phi 40$	YB5-AS542	
		N/O+N/C		Red $\Phi 40$	YB5-AS545	
 YB5-AC31	蘑菇钮自复 Mushroom head Spring return	N/C		Red $\Phi 40$	YB5-AC42	
		N/O		Black $\Phi 40$ Green $\Phi 40$	YB5-AC21 YB5-AC31	
 YB5-AV64	指示灯 Direct bulb included BA9S base fitting Neon LED (BA9S)	130V		White	YB5-AV61	
		220~240V		Green	YB5-AV63	
		50Hz		Red	YB5-AV64	
				Yellow	YB5-AV65	
			Blue	YB5-AV66		
 YB5-AVM□	指示灯 Direct bulb included BA9S base fitting Neon LED (BA9S)	N/O		White 7	YB5-AVB□	
		+		Green 3	YB5-AVB□	
		N/C		Red 4	YB5-AVB□	
				Yellow 5	YB5-AVG□	
				Blue 6	YB5-AVG□	
				B-24V G-110V M-220V	YB5-AVM□ YB5-AVM□ YB5-AVM□	
 YB5-AW3361	指示灯 Direct bulb supplied Neon LED (BA9S)	N/O		White	YB5-AW3161	
		130V		Green	YB5-AW3361	
		220~240V		Yellow	YB5-AW3561	
		N/C		Blue	YB5-AW3661	
				Red	YB5-AW3462	
 YB5-AL8325	双头按钮(不带灯) 1 flush green button 1 flush red button Unmarked Without pilot light IP40	N/O+N/C		Green	YB5-AL8325	
				Red	YB5-AL8425	
	1 flush green button 1 convex red button marked Without pilot light IP40			Green Red	YB5-AL8325 YB5-AL8425	

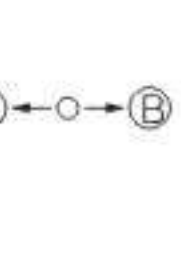
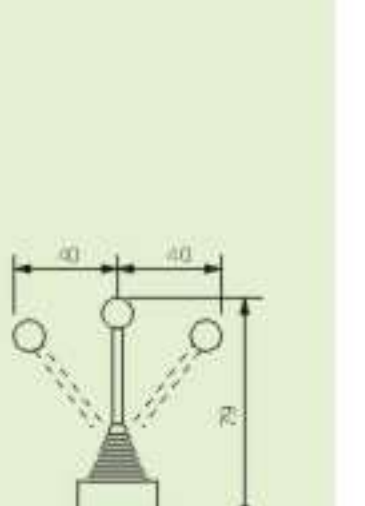
YB5系列按钮
YB5 Push button series

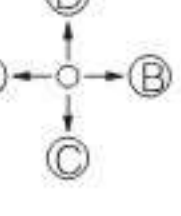
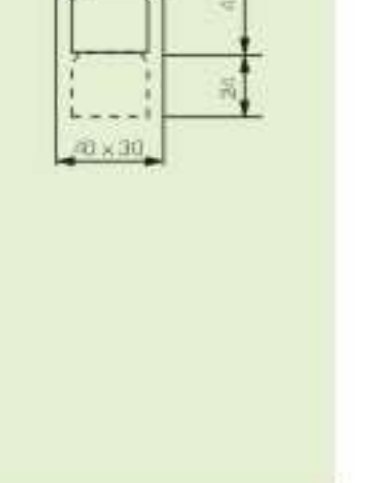
按钮 Push button	说明 Description	触点类型 Contact type	电路 Circuit	颜色 Color	型号 Type	外形尺寸 Dimensions
 YB5-AL9325	双头防水按钮 Without pilot light 1 flush green button 1 flush red button (with water-proof cover) marked IP66	N/O		White Green Red	YB5-AL9325	
		N/C		White Green Red	YB5-AL9425	
 YB5-AW8465	双头带灯按钮 Pilot light with yellow lens direct supply 220~240V BA9S bulb marked IP40 Neon LED (BA9S)	1 flush green button 1 flush red button		Red Yellow Green	YB5-AW8365 YB5-AW83B5 YB5-AW83G5 YB5-AW83M5	
		+		B-24V G-110V M-220V	YB5-AW8465 YB5-AW84B5 YB5-AW84G5 YB5-AW84M5	
 YB5-AW36G5	带灯按钮 Push button with lamp	N/O		White	YB5-AW33B5	
		+		Green	YB5-AW34B5	
		N/C		Red	YB5-AW35B5	
				Yellow	YB5-AW33G5 YB5-AW34G5 YB5-AW35G5	
			Blue	YB5-AW33M5 YB5-AW34M5 YB5-AW35M5		
 YB5-AK125B5	二位旋钮带灯24V 2 Position stay put	N/O		Green	YB5-AK123B5	
		+		Red	YB5-AK124B5	
		N/C		Yellow	YB5-AK125B5	
				Green	YB5-AK133G5	
				Red	YB5-AK134G5	
				Yellow	YB5-AK135G5	
 YB5-PA12	2位 2 Position				YB5-PA12	
					YB5-PA22	
 YB5-PA14	4位 4 Position	N/O			YB5-PA14	

YB5系列按钮 YB5 Push button series

按钮 Push buttons	说明 Description	颜色 Color	型号 Type
	平头按钮头 Flush button head	● Black ● Green ● Red ● Yellow ● Blue	YB5-AA2 YB5-AA3 YB5-AA4 YB5-AA5 YB5-AA6
	平头按钮头 Flush button head Marked	① Green ② Green ⓪ White Ⓛ Black ● Red ● Red	YB5-AA331 YB5-AA336 YB5-AA334 YB5-AA335 YB5-AA432 YB5-AA434
	凸头按钮头 Convex button head	● Black ● Green ● Red ● Yellow ● Blue	YB5-AL2 YB5-AL3 YB5-AL4 YB5-AL5 YB5-AL6
	凸头按钮头 Convex button head Marked	① Green ② Green ⓪ White Ⓛ Black ● Red ● Red	YB5-AL331 YB5-AL336 YB5-AL334 YB5-AL335 YB5-AL432 YB5-AL434
	带罩按钮头 Flush button head (with water-proof cover) Unmarked	● Black ● Green ● Red ● Yellow ● Blue	YB5-AP2 YB5-AP3 YB5-AP4 YB5-AP5 YB5-AP6
	指示灯头 Pilot light head	● Green ● Red ● Yellow ● Blue	YB5-AV03 YB5-AV04 YB5-AV05 YB5-AV06
	指示灯头 Pilot light head, the button is flush	● Green ● Red ● Yellow ● Blue	YB5-AW33 YB5-AW34 YB5-AW35 YB5-AW36

按钮 Push buttons	说明 Description	颜色 Color	型号 Type
	2-positions stay put spring return	● Black	YB5-AD2 YB5-AD3 YB5-AD4 YB5-AD5
	2-positions stay put 3-positions stay put 2-positions spring return 3-positions spring return	● Black	YB5-AJ2 YB5-AJ3 YB5-AJ4 YB5-AJ5
	2-positions stay put 2-positions spring return 3-positions stay put 3-positions spring return		YB5-AG2 YB5-AG3 YB5-AG4 YB5-AG7
	Mushroom head return to release by key	● Black Φ40 ● Red Φ40	YB5-AS12 YB5-AS14
	Return to release by Push put spring return	● Red Φ40 ● Red Φ40 ● Black Φ40 ● Green Φ40 ● Red Φ40	YB5-AS54 YB5-AT54 YB5-AC2 YB5-AC3 YB5-AC4
	1 flush green 1 flush red Unmarked	■ Green ■ Red	YB5-AL83
	1 flush green 1 convex red Marked	① Green Ⓛ Red	YB5-AL84
	Lamp-head 1 flush green 1 flush red Unmarked	■ Red ■ Yellow ■ Green	YB5-AW83
	Lamp-head 1 flush green 1 convex red Marked	① Red Ⓛ Yellow Ⓛ Green	YB5-AW84

YB5系列按钮 YB5 Push button series

按钮 Push buttons	说明 Description	触点 Contact	型号 Type
	Contact element	N/O	YB4-BE101
	Contact element	N/O	YB4-BE102
	Metal bracket		YB4-B
	Plastic bracket		YB5-A
	Contact element with lamp Direct type LED		YB5-AV6L
	Contact element with lamp Direct type Neon LED (BA9S)		YB5-AV06L
	Plastic bracket+ contact element	N/O	YB5-AZ101
	Plastic bracket+ contact element	N/O	YB5-AZ102
	Plastic bracket+ 2 contact element	N/O+N/C	YB5-AZ103
	Plastic bracket+ 2 contact element	N/O+N/C	YB5-AZ105
	Metal bracket+ contact element	N/O	YB4-BZ101
	Metal bracket+ contact element	N/O	YB4-BZ102
	Metal bracket+ 2 contact element	N/O+N/C	YB4-BZ103
	Metal bracket+ 2 contact element	N/O+N/C	YB4-BZ105

AD6(AD16、AD22)系列指示灯 AD6(AD16、AD22) series indicator lamp

Products instruction

AD6 (LED) series of indicator is equally used LED shining chip as light source. Because of long life, low consumption, small volume and light weight, it is a product replaced the older kind of incandescent lamp and indicator of neon lamp by new ones. AD6 indicators are produced by our factory enjoying following characters: high brightness, good reliability, beautiful shape and careful manufacture. Products are well praised by lots of clients, it is possible to meet all kinds of international standard lamp shade. Which are made of polycarbonate with high intensity and enjoying better anti surge performance, and bolt-type connector designed will make it safer and more convenient. All improvement will be provided to make your choice more convenient and your design perfect.

Use

AD6(LED) series of indicator are used as indicating, foretelling, accident and other signals in the lines of equipment (such as electrical power, telecommunication, machine tool, watercraft, textile, printing and mine machinery, etc.)

Main technical parameter

1. Voltage of working frequency: 2.5kV(AC valid value), 1 min
2. Insulated resistance $\geq 2M\Omega$
3. Voltage wave allowed by AC indicator $\pm 20\%$
4. Continual working life $\geq 30000h$
5. Brightness $\geq 60cd/m^2$
6. Index of leakage CT1 ≥ 100
7. Protection grade is IP40, and it is possible to be made to up to IP67
8. Using frequency: AC60~60Hz

Contrast list of voltage, current

Supply voltage	AC/DC							DC	FD	AC		
	6	12	24	36	48	110	127					
Voltage(V)	6	12	24	36	48	110	127	220	380	500	220	380
Current(A)	140	72	18-72	18	18	18	16	12	12	12	16	17

Note: "FD" in the list means a discharging lamp can be installed on the cupboard of capacitor. PG denotes pure green, PB denotes pure blue, PW denotes pure white.

Applicable environment

1. Surrounding temperature: $-25^{\circ}C \sim +55^{\circ}C$
2. Relative humidity: $\leq 98\%$
3. It can normally work under the conditions of 2-80Hz vibration frequency and 0.7g/h accelerated speed
4. Pollution grade: III; Installed sort III
5. It is possible to work under the moist tropical environment if there is a "TH" sign

Circuit introduction

1. AC and DC Indicator (AC, DC6V~220V)

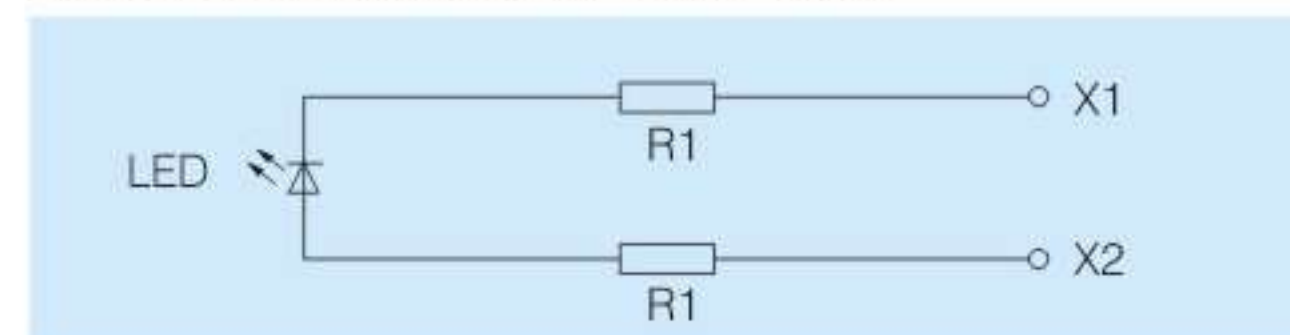

Note: It should be considered radiating condition when DC is up to 110V, 220V and 380V, for there is a great of heat

2. AC indicator(AC220V, AC380V)

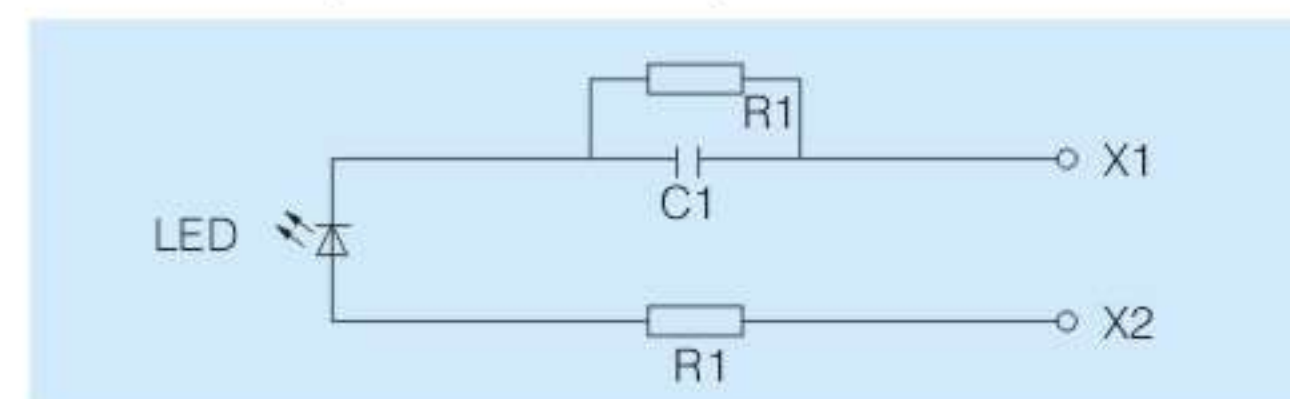

3. Return of double-color indicator(DC,AC110~220V)

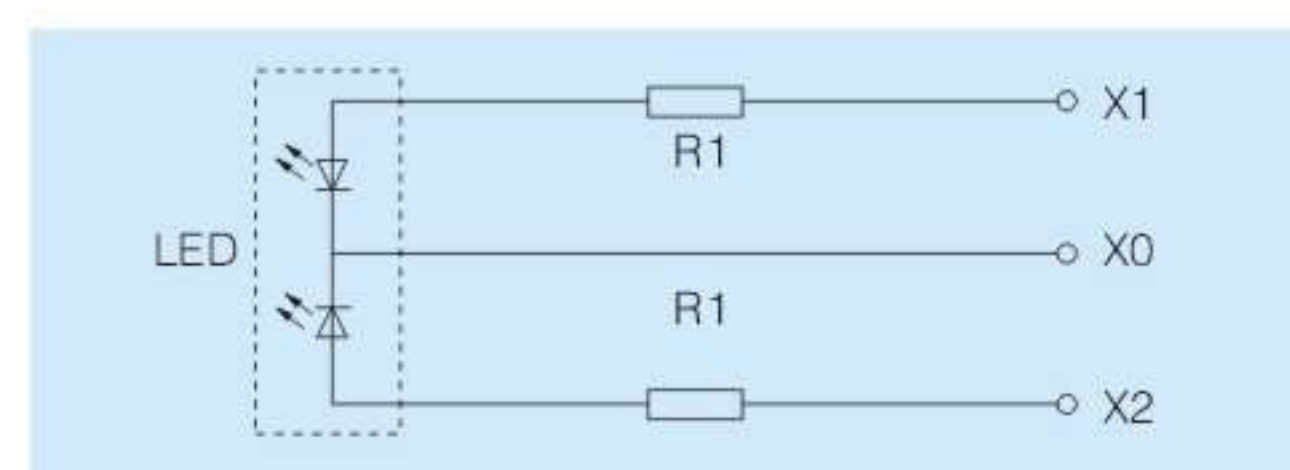









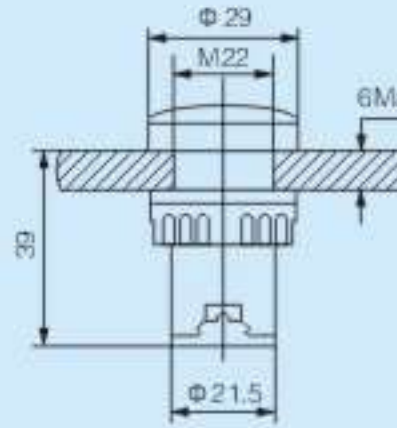

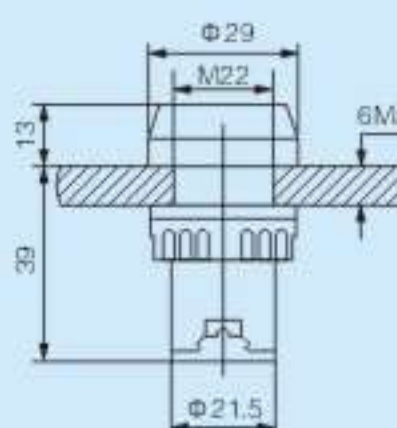
Note: When put t rough X0 and X1, lamp is shining green when done X0 and X2, lamp is shining red.

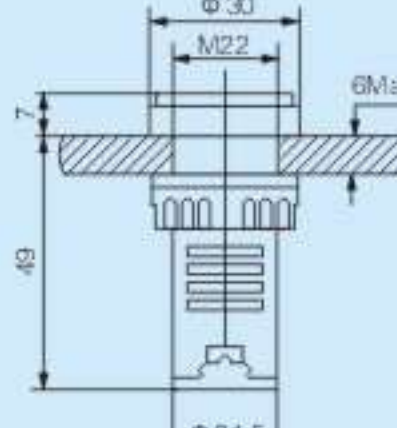

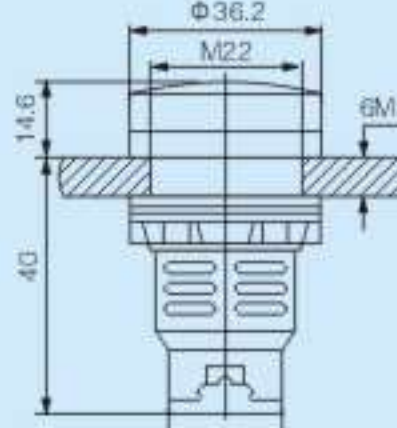

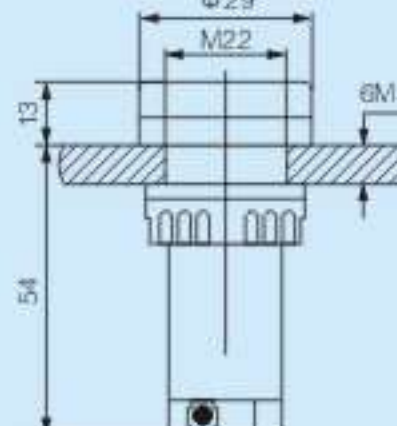
AD6(AD16、AD22)系列指示灯 AD6(AD16、AD22) series indicator lamp

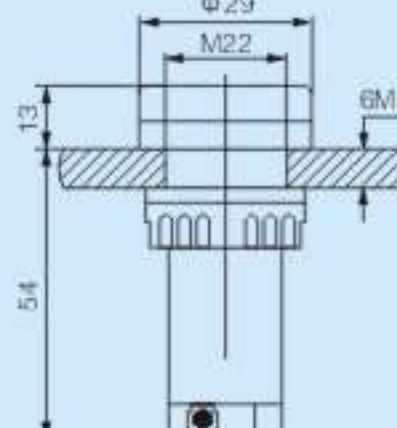
按钮 Push button	说明 Description	电压 Voltage	颜色 Color	型号 Type	外形尺寸 Dimensions
	Protected LED 指示灯 Indicator	24V AC/DC 36V AC/DC 48V AC/DC 110V AC 127V AC 220V AC	● Red ● Green/PG ● Yellow ● Pure Blue ○ White/PW	AD6-16DS	
	Protected LED 指示灯 Indicator	24V AC/DC 36V AC/DC 48V AC/DC 110V AC/DC 127V AC/DC 220V AC/DC	● Red ● Green ● Yellow ● Pure Blue ○ White/PW	AD6-16D	
	Protected LED 指示灯 Indicator	24V AC/DC 36V AC/DC 48V AC/DC 110V AC/DC 127V AC/DC 220V AC/DC	● Red ● Yellow ● Green ● Pure Green ● Pure Blue ○ White/PW	AD6-16A	
	Protected LED 指示灯 Indicator	24V AC/DC 36V AC/DC 48V AC/DC 110V AC/DC 127V AC/DC 220V AC/DC	● Red ● Green/PG ● Yellow ● Pure Blue ○ White/PW	AD6-22DS	
	Protected LED 指示灯 Indicator	24V AC/DC 36V AC/DC 48V AC/DC 110V AC/DC 127V AC/DC 220V AC/DC	● Red ● Green/PG ● Yellow ● Pure Blue ○ White/PW	AD6-22DSN抗感应	
	Protected LED 指示灯 Indicator	24V AC/DC 36V AC/DC 48V AC/DC 110V AC/DC 127V AC/DC 220V AC/DC	● Red ● Green/PG ● Yellow ● Pure Blue ○ White/PW	AD6-22D	

AD6(AD16、AD22)系列指示灯
AD6(AD16、AD22) series indicator lamp

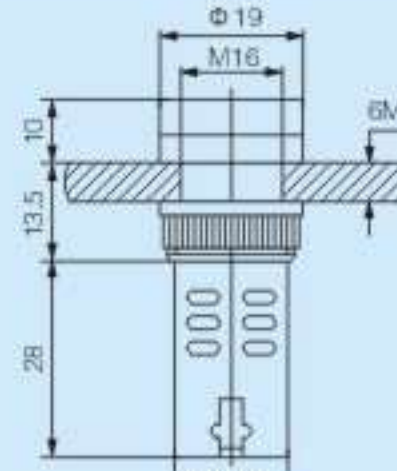
按钮 Push button	说明 Description	电压 Voltage	颜色 Color	型号 Type	外形尺寸 Dimensions
	Protected LED 指示灯 Indicator	24V AC/DC 36V AC/DC 48V AC/DC 110V AC 127V AC 220V AC	● Red ● Green/PG ● Yellow ● Pure Blue ○ White/PW	AD6-22CS AD6-22CSL AD6-22CSC	
AD6-22CS					
	Protected LED 指示灯 Indicator	24V AC/DC 36V AC/DC 48V AC/DC 110V AC/DC 127V AC/DC 220V AC/DC	● Red ● Green ● Yellow ● Pure Blue ○ White/PW	AD6-22BS	
AD6-22BS					
	Protected LED 指示灯 Indicator	24V AC/DC 36V AC/DC 48V AC/DC 110V AC/DC 127V AC/DC 220V AC/DC	● Red ● Yellow ● Green ● Pure Green ● Pure Blue ○ White/PW	AD6-22F	
AD6-22F					
	Protected LED 指示灯 Indicator	24V AC/DC 36V AC/DC 48V AC/DC 110V AC/DC 127V AC/DC 220V AC/DC 380V AC	● Red ● Green/PG ● Yellow ● Pure Blue ○ White/PW	AD6-30DS AD6-30DSL AD6-30DSC	
AD6-30DS					
	Protected LED 指示灯 Indicator	110V AC/DC 127V AC/DC 220V AC/DC 380V AC	● Red&Green ● Red&Pure Blue	AD6-22DRG AD6-22DRB	
AD6-22DRG					
	Protected LED 指示灯 Indicator	110V AC/DC 127V AC/DC 220V AC/DC 380V AC	⊕	AD6-22WG	
AD6-22WG					

AD6(AD16、AD22)系列指示灯
AD6(AD16、AD22) series indicator lamp

按钮 Push button	说明 Description	电压 Voltage	颜色 Color	型号 Type	外形尺寸 Dimensions
	Protected LED 指示灯 Indicator	110V AC/DC 127V AC/DC 220V AC/DC 220V AC	⊕ ⊖	AD6-22WD AD6-22WN	
AD6-22WD					
	Protected LED 指示灯 蜂鸣器 Indicator Buzzer	24V AC/DC 36V AC/DC 48V AC/DC 110V AC/DC 127V AC/DC 220V AC/DC	● Red ● Black	AD6-16MR AD6-16MK	
AD6-16MR					
	蜂鸣器 Buzzer	24V AC/DC 36V AC/DC 48V AC/DC 110V AC/DC 127V AC/DC 220V AC/DC	● Black	AD6-22MK	
AD6-22MK					
	Protected LED 指示灯 蜂鸣器 Indicator Buzzer	24V AC/DC 36V AC/DC 48V AC/DC 110V AC/DC 127V AC/DC 220V AC/DC	● Red	AD6-22MR	
AD6-22MR					
	Protected LED 指示灯 蜂鸣器 Indicator Buzzer	24V AC/DC 36V AC/DC 48V AC/DC 110V AC/DC 127V AC/DC 220V AC/DC	● Red	AD6-22BMR	
AD6-22BMR					
	蜂鸣器 Buzzer	24V AC/DC 36V AC/DC 48V AC/DC 110V AC/DC 127V AC/DC 220V AC/DC	● Black	AD6-22MFB	
AD6-22BMK					

AD6(AD16、AD22)系列指示灯
AD6(AD16、AD22) series indicator lamp

按钮 Push button	说明 Description	电压 Voltage	颜色 Color	型号 Type	外形尺寸 Dimensions
	蜂鸣器 Buzzer	24V AC/DC 36V AC/DC 48V AC/DC 110V AC/DC 127V AC/DC 220V AC/DC 380V AC	● Black	AD6-30MK	
AD6-30MK					
	蜂鸣器 Buzzer	24V AC/DC 36V AC/DC 48V AC/DC 110V AC/DC 127V AC/DC 220V AC/DC 380V AC	● Red	AD6-30MR	
AD6-30MR					

电位器
Potentiometer

项目Item	数据 Parameter			
电阻 Impedance(R)	1K Ω	2K Ω	5K Ω	10K Ω
额定功率 Rated power (P)	Linear 1.5W(70°C)			
防护等级 Protection degree	IP65			
绝缘电阻 Isolation resistance	min 10 Ω M(500DC)			
运行温度 Operating temperature	-5°C~+40°C			
电阻元件 Resistive element	sermet			
转动范围 Turning range	270° ± 15°			
公差 Tolerance	± 10%			
导热率 Thermal coefficient	%100ppm/°C			
介电性能 Dielectric endurance	± 1750Vrms			
气候类型 Climatic category	55/125/56			
最高运行电压 Maximum operation voltage(V)	38.70	38.70	86.60	122.50
最高通过电流 Maximun brush current (mA)	38.70	38.70	17.30	12.20

5K Ω

XAL 系列控制盒
XAL Control box series

按钮 Push button	说明 Description	触点类型 Contact type	电路 Circuit	标牌说明 Marking description	型号 Type	标记按钮 Marking on button
	一个绿色平钮 1 green flush push button spring return	N/O	13 14	Start - -	XAL-B101H29 XAL-B102 XAL-B103	● Green ① Green ● Green
XAL-B101H29						
	一个红色平钮 1 red flush push button spring return	N/C	21 22	Stop - -	XAL-B111H29 XAL-B114 XAL-B112	● Red ● Red ● Red
XAL-B164						
	一个红色蘑菇头 Φ40 1 red mushroom head push button Φ40 spring return	N/C	21 22	Emergency Stop Stop -	XAL-B164H29 XAL-B174H29 XAL-J174	自复 spring return 自锁 latching turn to release
XAL-B184H29						
	二位旋钮 1 selector switch 2 position stay put standard black handle	N/O	13 14	Start stop I O	XAL-B132H29 XAL-B134H29	旋钮 standard black handle
XAL-B132H29						
	二位钥匙旋钮 1 selector switch with key operated (key n° 445) 2 position stay put	N/O	13 14	Start stop I O	XAL-B142H29 XAL-B144H29	钥匙 key release
XAL-B142H29						
	二位自复平钮 2 spring return push button 1 flush green 1 flush red	N/O+N/C	13 14 21 22	Open close Start stop - -	XAL-B241H29 XAL-B244H29 XAL-B213 XAL-B215	● Green ● Red ● Green ● Red ① Green ● Red ● Green ● Red
XAL-B211H29						

XAL 系列控制盒 XAL Control box series

按钮 Push button	说明 Description	触点类型 Contact type	电路 Circuit	标牌说明 Marking description	型号 Type	标记按钮 Marking on button
	二个自复平钮 2 spring return push button 1 flush white 1 flush black	N/O+N/O			XAL-B222	
					XAL-B223	
	三个自复平钮 3 spring return push button 1 flush white 1 flush red 1 flush black	N/O + N/C +		- - forward stop reverse up stop down open stop close	XAL-B324 XAL-B334 XAL-B339 XAL-B311H29 XAL-B321H29 XAL-B341H29	
	二个自复平钮 一个直接式指示灯 1 red pilot light directly supplied 2 spring return push button 1 flush red 1 flush green	N/O + N/C		Start Stop - - Start Stop - -	XAL-B361H29 XAL-B363 XAL-B366 XAL-B37H29 XAL-B373 XAL-B376	
	四个自复平钮 4 spring return push button 1 flush red 1 flush green 1 flush white 1 flush black	N/O + N/O + N/O + N/C			XAL-B411	











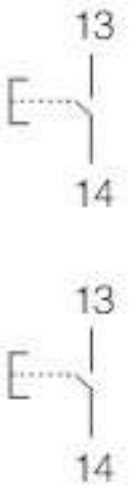

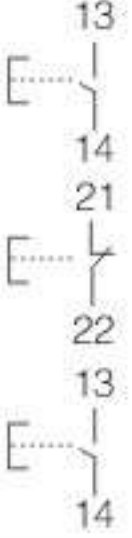
XAL 系列控制盒 XAL Control box series

按钮 Push button	说明 Description	触点类型 Contact type	电路 Circuit	标牌说明 Marking description	型号 Type	标记按钮 Marking on button
	一个绿色平钮 1 green flush push button spring return	N/O		Start - -	XAL-D101H29 XAL-D102 XAL-D103	
	一个红色平钮 1 red flush push button spring return	N/C		Stop - -	XAL-D111H29 XAL-D114 XAL-D112	
	一个红色蘑菇头 推按钮 Φ40 1 red mushroom head push button Φ40 spring return	N/C		Emergency Stop Stop -	XAL-D164H29 XAL-D174H29 XAL-D174	自复 spring return 自锁 latching turn to release
	一个红色蘑菇头 推按钮 Φ40 1 red mushroom head pushbutton Φ40mm latching key release (key n° 445)	N/C		Emergency Stop	XAL-D184H29	钥匙 key release
	二位旋钮 1 selector switch 2 position stay put standard black handle	N/O		Start stop I O	XAL-D132H29 XAL-D134H29	旋钮 standard black handle
	二位钥匙旋钮 1 selector switch with key operated (key n° 445) 2 position stay put	N/O		Start stop I O	XAL-D142H29 XAL-D144H29	钥匙 key release
	二位自复平钮 2 spring return push button 1 flush green 1 flush red	N/O+N/C		Open close Start stop - -	XAL-D241H29 XAL-D244H29 XAL-D213 XAL-D215	

XAL-D213

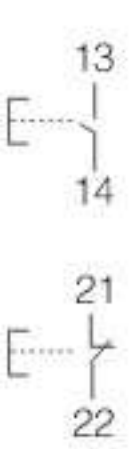
XAL 系列控制盒 XAL Control box series

按钮 Push button	说明 Description	触点类型 Contact type	电路 Circuit	标牌说明 Marking description	型号 Type	标记按钮 Marking on button
	二个自复平钮 2 spring return push button 1 flush white 1 flush black	N/O+N/O			XAL-D222	
	三个自复平钮 3 spring return push button 1 flush white 1 flush red 1 flush black	N/O + N/C + N/O			XAL-D324 XAL-D334 XAL-D339	
	三个自复平钮 3 spring return push button 1 flush white 1 flush red 1 flush black	N/O + N/C + N/O		Forward stop reverse up stop down open stop close	XAL-D311H29 XAL-D321H29 XAL-D341H29	
	二个自复平钮 一个直接式指示灯 1 red pilot light directly supplied 2 spring return push button 1 flush red 1 flush green	N/O + N/C		Start Stop - - Start Stop - -	XAL-D361H29 XAL-D363 XAL-D366 XAL-D37H29 XAL-D373 XAL-D376	



XAL-D01

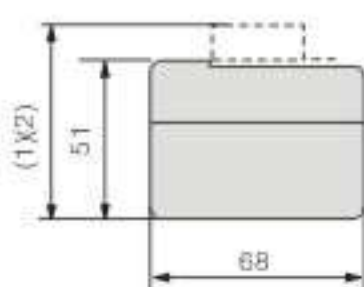



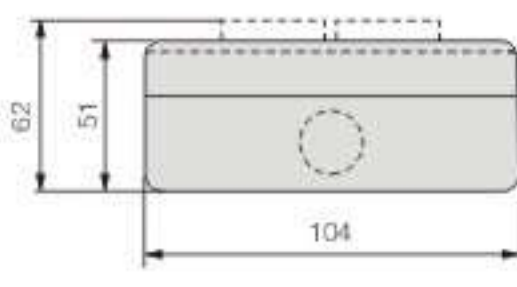



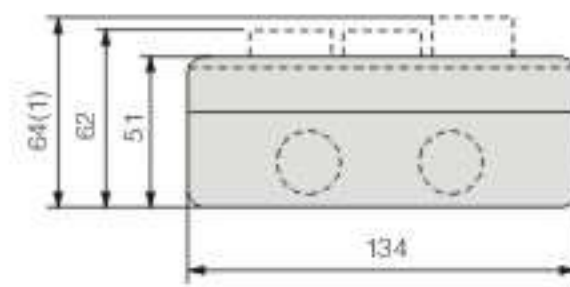



XAL-D02



XAL-D03



HJ9 系列控制盒 HJ9 Control box series

按钮 Push buttons	说明 Description	型号 Type	按钮 Push buttons	说明 Description	型号 Type
	单孔按钮盒 Button box for single hole IP40 Φ22 Φ25 Φ30	HJ9-1Y HJ9-1W		四孔按钮盒 Button box for four holes IP40 Φ22 Φ25 Φ30	HJ9-4Y HJ9-4W
	二孔按钮盒 Button box for Two holes IP40 Φ22 Φ25 Φ30	HJ9-2Y HJ9-2W		五孔按钮盒 Button box for five holes IP40 Φ22 Φ25 Φ30	HJ9-5Y HJ9-5W
	三孔按钮盒 Button box for Three holes IP40 Φ22 Φ25 Φ30	HJ9-3Y HJ9-3W		六孔按钮盒 Button box for six holes IP40 Φ22 Φ25 Φ30	HJ9-6Y HJ9-6W
	单孔按钮盒 Button box for single holes IP40 Φ22 Φ25 Φ30	TYX-1		三孔按钮盒 Button box for three holes IP40 Φ22 Φ25 Φ30	TYX-3
	二孔按钮盒 Button box for Two holes IP40 Φ22 Φ25 Φ30	TYX-2		四孔按钮盒 Button box for four holes IP40 Φ22 Φ25 Φ30	TYX-4









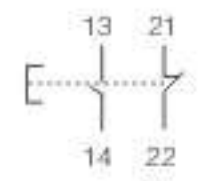
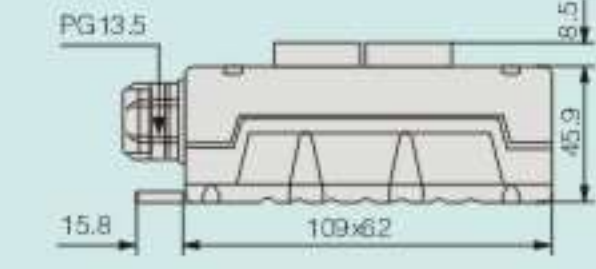
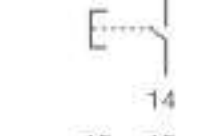
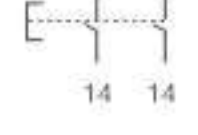

TYX-1

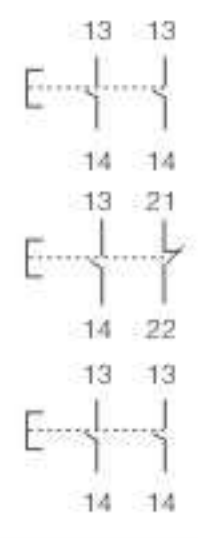
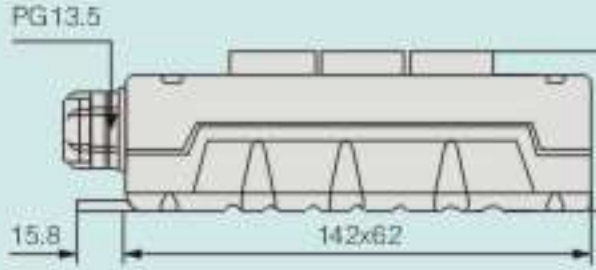
TYX-3

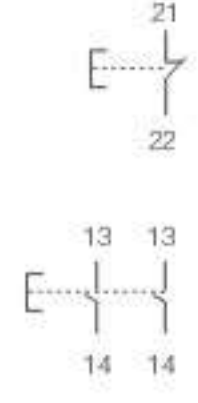
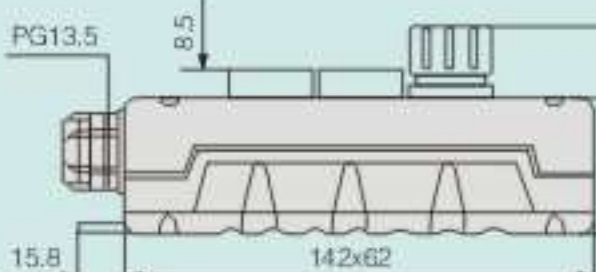
TYX-2

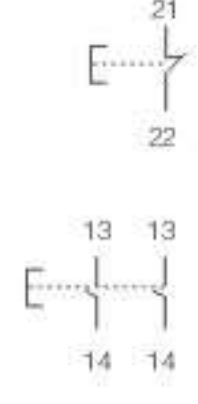
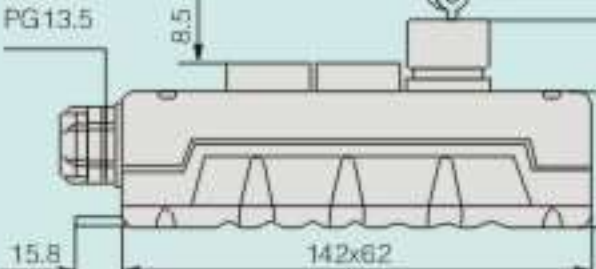
TYX-4

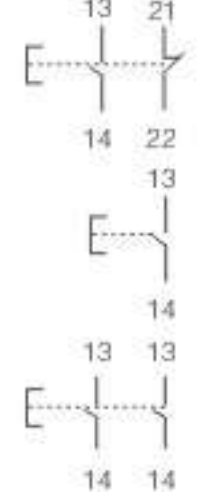
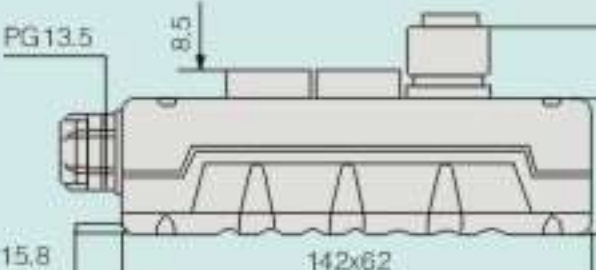
COP-B 系列液压尾板控制盒 COP-B Control box series

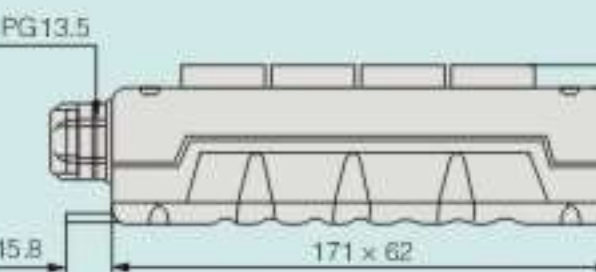
按钮 Push button	说明 Description	触点类型 Contact type	电路 Circuit	型号 Type	外形尺寸 Dimensions
	2 holes spring return push button 1 flush black 1 flush white IP54	NO+N/C		COP-2B11	
		2xN/O		COP-2B10	
		2x2N/O		COP-2B20	
	2 holes spring return push button 1 flush black 1 flush white IP54	2N/O + NO+N/C + 2N/O		COP-3B	
	3 holes control box 1 black spring return button 1 white spring return button 1 red emergency button turn to release IP54	NC 2x2N/C		COP-A2B	
	3 holes control box 1 black spring return button 1 white spring return button 1 red mushroom button release to center IP54	NC 2x2N/O		COP-Y2B	
	3 holes control box 1 black spring return button 1 white spring return button 1 black selector switch release to center IP54	NO+N/C + 2N/O + 2N/O		COP-X2B	
	4 holes spring return push button 1 flush black 1 flush white 1 flush black 1 flush white IP54	4x2N/O		COP-4B	

XAC 系列吊机控制站 XAC Pendant control stations series

□使用条件 Applicable environment

Conforming to standards	IEC947-5-1, EN60947-5-1, IEC337-1, NFC63-146, VDE0660-200
Approvals	NEMKO. Special version: UL Listed A600-Q600, CSAA600-Q600
Shock resistance	100g conforming to IEC68-2-27
Electric chock protectin	Class II conforming to IEC 536 and NF C 20-030
Degree of protection	Op.cycles IP65 conforming to IEC 539, IP657 conforming to NF C20-010
Mechanical durability	1 million
Enclosure	A Double insulated polypropylene, coloured yellow throughtout
Thermal current(Ith)	V 10
Rated insulation voltage(Ui)	ZB2-BEY ●●●●, XEN-G ●●●●, XAC-S ●●●●: 600, degree of pollution 3 XEN-T ●●●●: 400, degree of pollution 3
Rated impulse withstand voltage(Uimp) kV	6 conforming to IEC947-1
Positive operation	Mushroom head pushbutton: N/C contact with positive opening operation to IEC947-5-1 section 3
Contace operation	N/C of N/O slow break
Terminal referencing	Conforming to CENELEC EN 50013
Short-circuit protection	10A cartridge fuse type gG(gI)
Cabling	mm ² Screw and captive cable clamp terminals. Capacity: min.1x0.5,max., with or without cable end; 2x1.5 or 1x2.5mm 2.6,3mm fast on connectors (on request), please consult your Regional customer centre

□外形尺寸 Dimensions

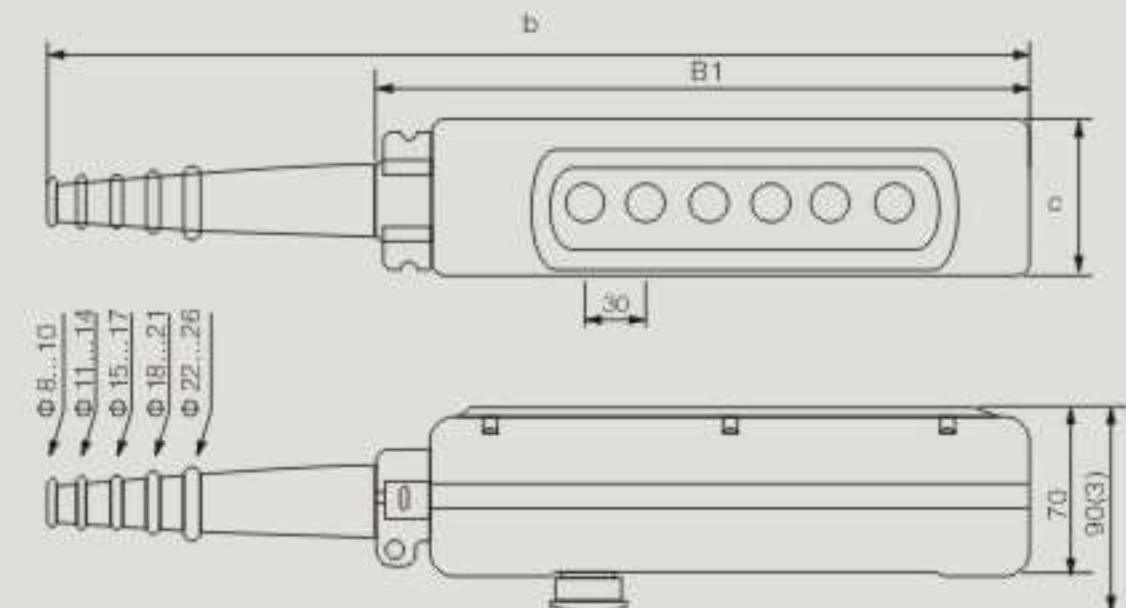

For control of single-speed reversing motor (contact blocks ZB2-BE101+ZB2-BE102)

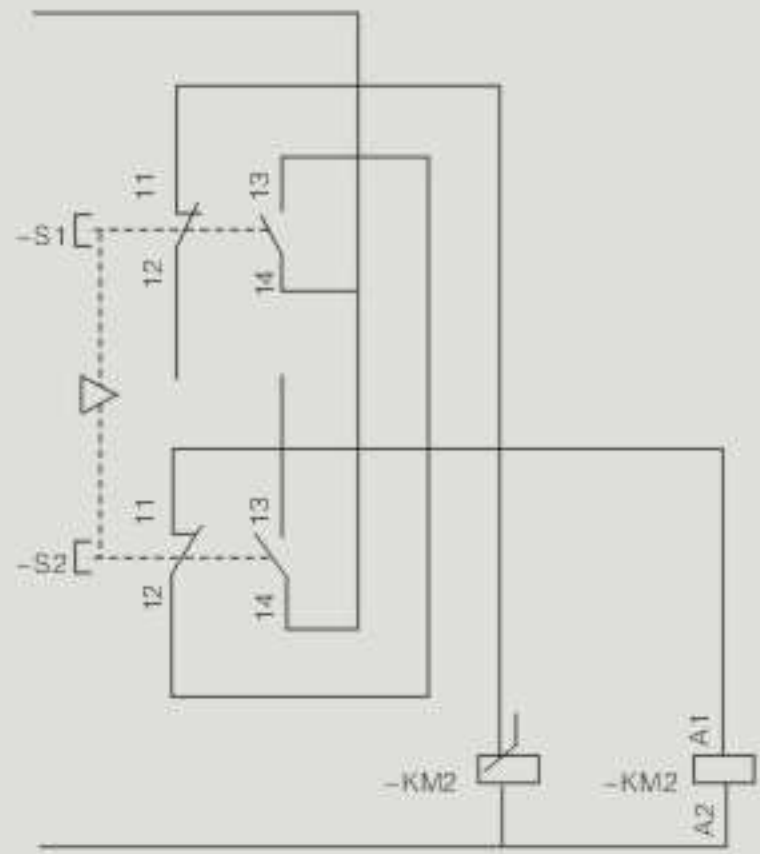

Number of ways	2	3	4	6	8	12
b	314	314	440	500	560	680
b1	190	190	250	310	370	490
c	80	80	80	80	80	92

1. For 2 and 3 -way XAC-A stations
2. For 4 of 8-way XAC-A stations
3. With mushroom head opeator

For control of single-speed reversing motor (contact blocks XEN-G1191)

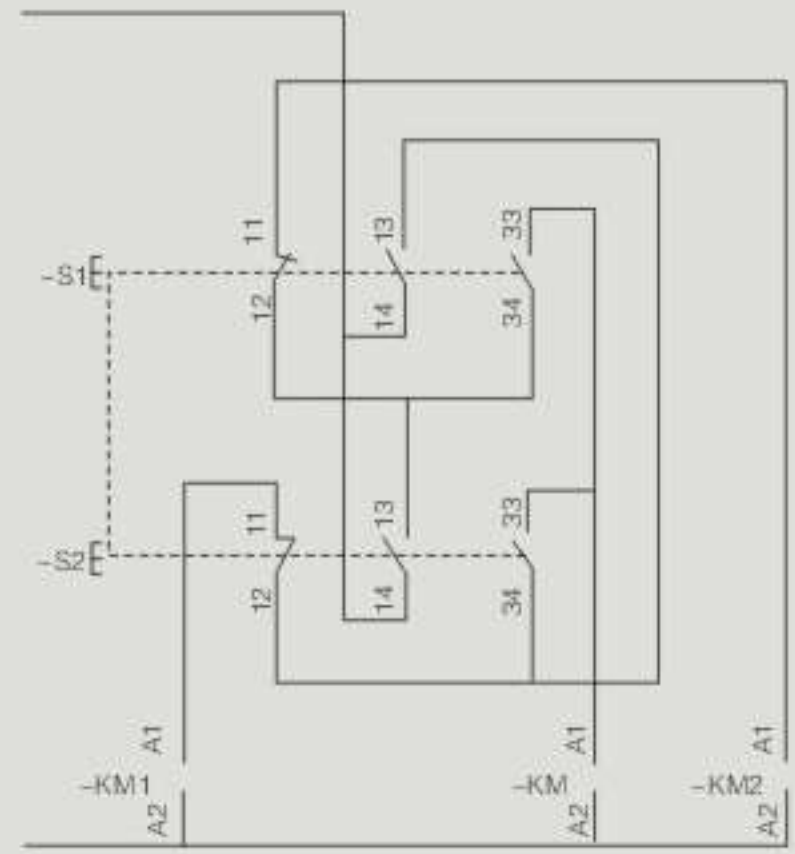













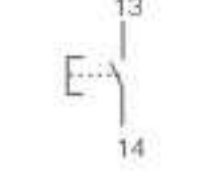
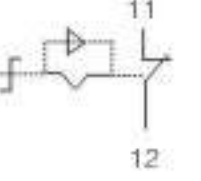
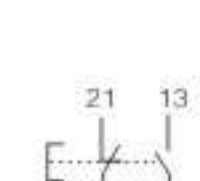
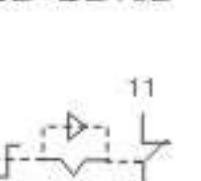

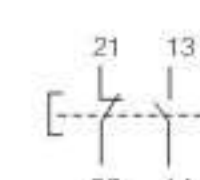
KM: high speed contactor

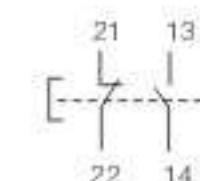
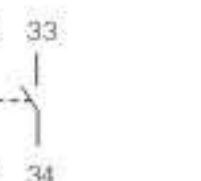

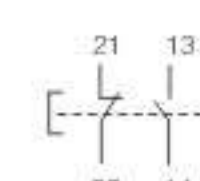





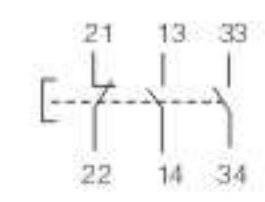

XAC系列吊机控制站
XAC Pendant control stations series

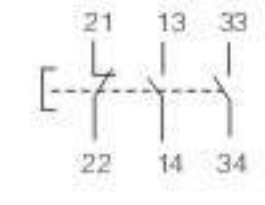
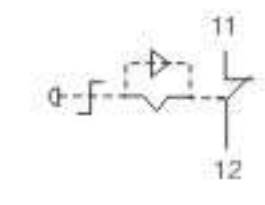
控制站 Control stations	说明 Description	contact blocks and scheme per direction for "emergency stop"	型号 Type
	For control of single-speed motor	ZB2-BE101 	XAC-A271
	2 mechanically interlocked	ZB2-BE102 + ZB2-BE101 	XAC-A281
	2 mechanically interlocked +1 trigger action latching "Emergency stop" Φ30mm operator ZA2-BS44	ZB2-BE101  ZB2-BE102 	XAC-A2713
		ZB2-BE102 + ZB2-BE101  ZB2-BE102 	XAC-A2813
	For control of single-speed motor	ZB2-BE101 	XAC-A471
	4 mechanically interlocked between pairs	ZB2-BE102 + ZB2-BE101 	XAC-A481
	4 mechanically interlocked +1 trigger action latching "Emergency stop" Φ40mm operator ZA2-BS44	ZB2-BE101  ZB2-BE102 	XAC-A4713
		ZB2-BE102 + ZB2-BE101  ZB2-BE102 	XAC-A4813
	For control of single-speed motor	ZB2-BE101 	XAC-A671
	6 mechanically interlocked between pairs	ZB2-BE102 + ZB2-BE101 	XAC-A681
	6 mechanically interlocked between pairs +1 trigger action latching "Emergency stop" Φ40mm operator ZA2-BS44	ZB2-BE101  ZB2-BE102 	XAC-A6713
		ZB2-BE102 + ZB2-BE101  ZB2-BE102 	XAC-A6813

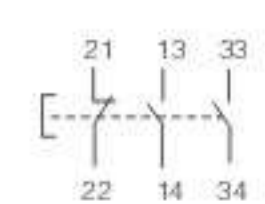
XAC系列吊机控制站
XAC Pendant control stations series

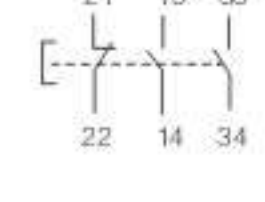
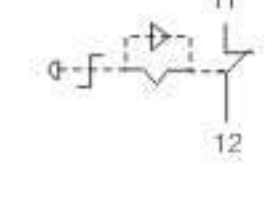
控制站 Control stations	说明 Description	contact blocks and scheme per direction for "emergency stop"	型号 Type
	For control of single-speed motor	ZB2-BE101 	XAC-A871
	6 mechanically interlocked between pairs	ZB2-BE102 + ZB2-BE101 	XAC-A881
	6 mechanically interlocked +1 trigger action latching "Emergency stop" Φ40mm operator ZA2-BS44	ZB2-BE101  ZB2-BE102 	XAC-A8713
		ZB2-BE102 + ZB2-BE101  ZB2-BE102 	XAC-A8813
	For control of single-speed motor	1N/C+N/O+N/O staggered XEN-G1191 	XAC-A291
	4 mechanically interlocked between pairs +1 trigger action latching "Emergency stop" Φ40mm operator ZA2-BS44	1N/C+N/O+N/O staggered XEN-G1191  1N/C ZB2-BE102 	XAC-A2913
	For control of single-speed motor	1N/C+N/O+N/O staggered XEN-G1191 	XAC-A491
	4 mechanically interlocked between pairs +1 trigger action latching "Emergency stop" Φ40mm operator ZA2-BS44	1N/C+N/O+N/O staggered XEN-G1191  1N/C ZB2-BE102 	XAC-A4913

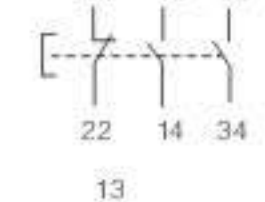
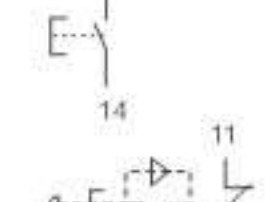
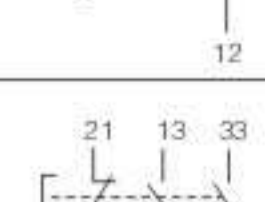
XAC系列吊机控制站 XAC Pendant control stations series

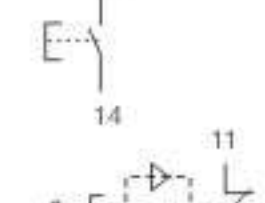
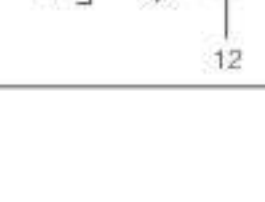
控制站 Control stations	说明 Description	contact blocks and scheme per direction for "emergency stop"	型号 Type
 XAC-A691	For control of two-speed motor 6 mechanically interlocked	1N/C+N/O+N/O staggered XEN-G1191 	XAC-A691
 XAC-A6913	6 mechanically interlocked between pairs + 1 trigger action latching "Emergency stop" Φ30mm operator ZA2-BS44	1N/C+N/O+N/O staggered XEN-G1191  1N/C ZB2-BE102 	XAC-A6913
 XAC-A891	8 mechanically interlocked between pairs	1N/C+N/O+N/O staggered XEN-G1191 	XAC-A891
 XAC-A8913	8 mechanically interlocked between pairs + 1 trigger action latching "Emergency stop" Φ40mm operator ZA2-BS54	1N/C+N/O+N/O staggered XEN-G1191  1N/C ZB2-BE102 	XAC-A8913
 XAC-A4923	4 mechanically interlocked between pairs + 1 trigger action latching "Emergency stop" Φ40mm operator ZA2-BS54	1N/C+N/O+N/O staggered XEN-G1191  1N/C102(b)  1N/C ZB2-BE102 	XAC-A4923
 XAC-A8923	8 mechanically interlocked between pairs + 1 trigger action latching "Emergency stop" Φ40mm operator ZA2-BS54	1N/C+N/O+N/O staggered XEN-G1191  1N/C102(b)  1N/C ZB2-BE102 	XAC-A8923

COP(COB)系列防雨型起重机用控制开关 COP(COB) Water-proof lifting button control switch Series

□产品用途

COP-系列防雨型起重设备用按钮式开关, 系仿国外同类产品基础上加以精心改进的产品, 扩大了使用功能, 其技术性能达到国外九十年代先进水平, 开关采用全前塑外壳, 结构合理, 产品配置橡胶电缆护套和防水密封条, 具有良好的防尘防雨淋性能, 其防护性能达到IP54级, 所以本开关特别适用于露天、有雨雪、多尘埃侵害环境的电路的控制系统中, 如起重机、电动葫芦等设备远距离控制。

除电源开关“通”按钮能自锁外, 其余按钮具有自动复位性能, 并且具有正反向控制的机械联锁机构, 不仅简化了电路, 而且有效地保护电路及设备运行。

该产品符合Q/YDD02-00, GB14048.5-2001和EN60947-5-1:1997标准。

□Products usage

Water-proof Lifting Button Switches of COP-series are precisely approved on the same kind of the domestic and foreign products. This enlarges the operational functions. The technical competence comes up to the advanced world standards of the nineties. The products are noted for their plastic outer casing, artistic appearance and rational design. Equipped with rubber protective casings and water-proof performance. The protective function reaches grade IP54. This is why our products are especially suitable for using in the circuit control system in the open air encroached upon by rain and snow such as in the remote control of lifters and electric bocks.

Except the self-lock of the on-button of the main switch, the other buttons all have the automatic and front-to-back control mechanical interlockers as well. It not only simplifies the circuit, but also effectively protects the motion of the circuit and the appliances. Q/YDD02-00, GB/4048.2001 and EN60947.5.1:1997.

□产品用途Models and meaning



□按钮标记Button marks



COPP系列防雨型起重机用控制站
COPP Pendant control stations series

间接控制系列

代号	电气原理图	特征	技术参数
A-控制电源开关		按钮自锁, 当接通或断开旋转30°, 自动复位	Ui: 500V~ Ith: 10A AC-15 380V~2A 220V~3.5A
B-起动停止钮		两组不联锁; 自动复位动作时, 常开先分断, 常开接通。(还有不同组合)	
S-双速钮		两组联锁, 自动复位, A型按钮至第一位时, 常开分断, 常开接通, 再按到底, 滞后常开接通; B型按钮至第一位时, 超前常开接通, 再按到底, 常开接通	
P-动合常开		旋柄自锁, 二位; 手动复位; 两钮不联锁(可联锁); 各钮一常开(一常闭一常开)	

该产品符合Q/YDD02-00, JEC.60947-5-1, GB14048.5-2001标准

外形及安装尺寸

代号	钮数	L×B×H
ZD2.655.031	3	310×78×85
ZD2.655.032	5	370×78×85
ZD2.655.033	7	430×78×85
ZD2.655.034	9	490×78×85
ZD2.655.035	11	550×78×85

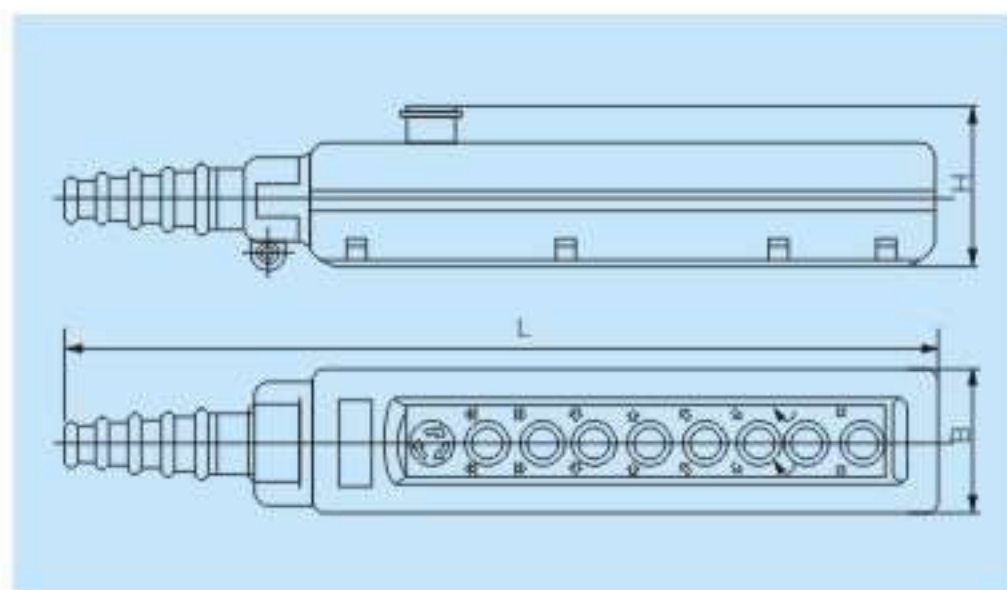

型号及含义



方向符号:

(双速)

(A钮) 控制电源开关

COPC系列防雨型起重机用控制站
COPC Pendant control stations series

间接控制系列

代号	电气原理图	特征	技术参数
A-控制电源开关		推锁旋放式急停钮; 一常闭(一常闭一常开)	Ui: 500V~ Ith: 10A AC-15 380V~2A 220V~3.5A
P-动合常开		两组联锁, 自动复位, 公共(也可单独)进线端; 各钮一常开(一常闭一常开)	
B-起动停止钮		两组不联锁(可联锁); 自动复位, 一钮常闭、一钮常开(各钮一常闭一常开)	
X-选择钮(组)		旋柄自锁, 二位; 手动复位; 两钮不联锁(可联锁); 各钮一常开(一常闭一常开)	

外形及安装尺寸

代号	钮数	L×B×H
ZD2.655.081	3	300×69×72
ZD2.655.082	5	360×69×72
ZD2.655.083	7	420×69×72
ZD2.655.084	9	480×69×72
ZD2.655.085	11	540×69×72

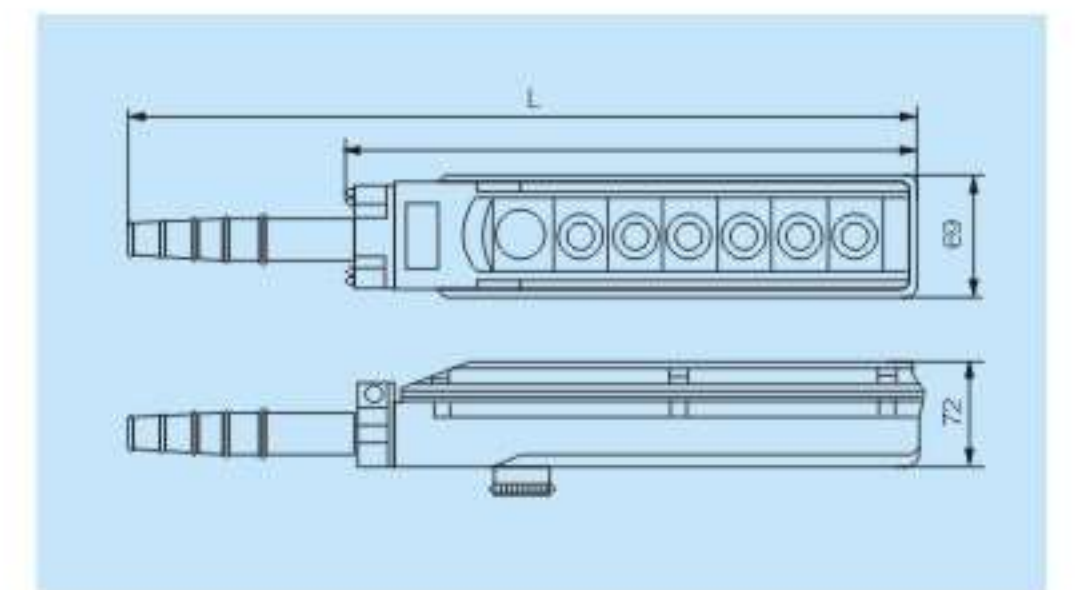

型号及含义

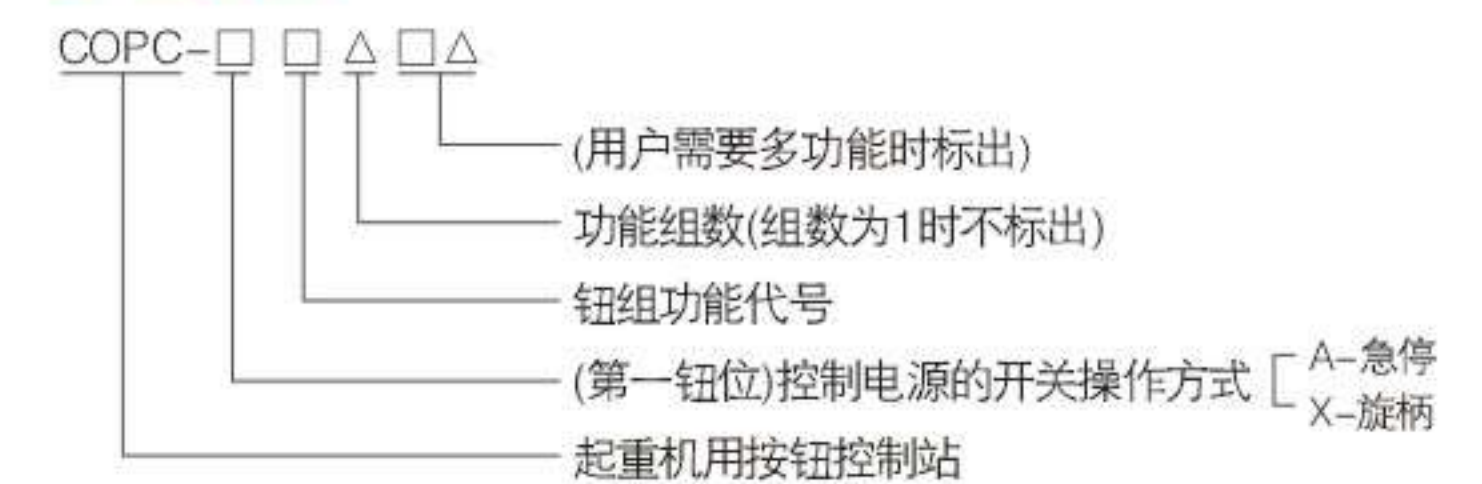

方向符号:

(双速)

(A钮) 控制电源开关

COPE系列防雨型电动葫芦按钮控制站
COPE Pendant control stations series

产品特点

COPE-防雨型葫芦按钮控制站是以国外链式双速电动葫芦开关为基础加以改进的产品。外观坚固美观, 握持轻巧, 正反(升降)按钮机械联锁, 自动复位; 每个钮设有两个档位(两付先后动合常开触头), 实现单钮快慢双速操作; 具有推锁旋放按钮作为紧急保护, 使操作更安全、可靠。产品具有IP65级防水防尘性能, 适用于有雨雪、多尘埃侵害的环境, 配套国内外多种单双速电动葫芦。

型号及含义

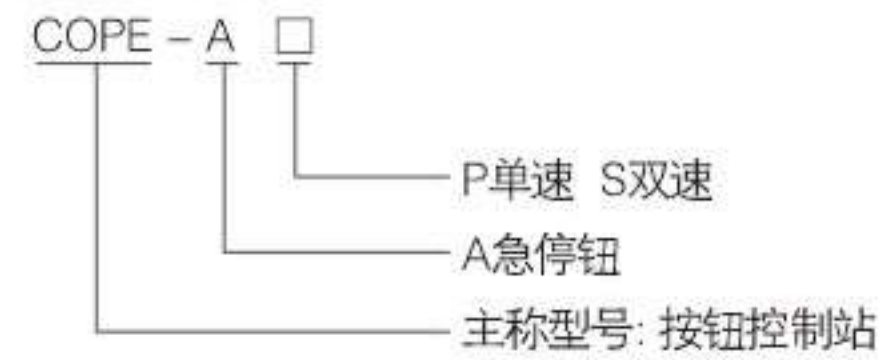

控制功能及电气原理图

代号	电气原理图	特征	技术参数
A-控制电源开关		推锁旋放式急停按钮: -常闭(-常闭-常开)。	Ur: 500V~ Ith: 10A AC-15 380V~2A 220V~3.5A
Sc双速钮		双速按钮至第一档位时 常开接通, 按至第二档 位另一位常开按钮(第 一位保持接通)。	
Sa或Sb双速钮		A型钮, 按至第一位时, 常闭分断, 常开接通; 再按到底, 滞后常开接 通。	

外形尺寸图

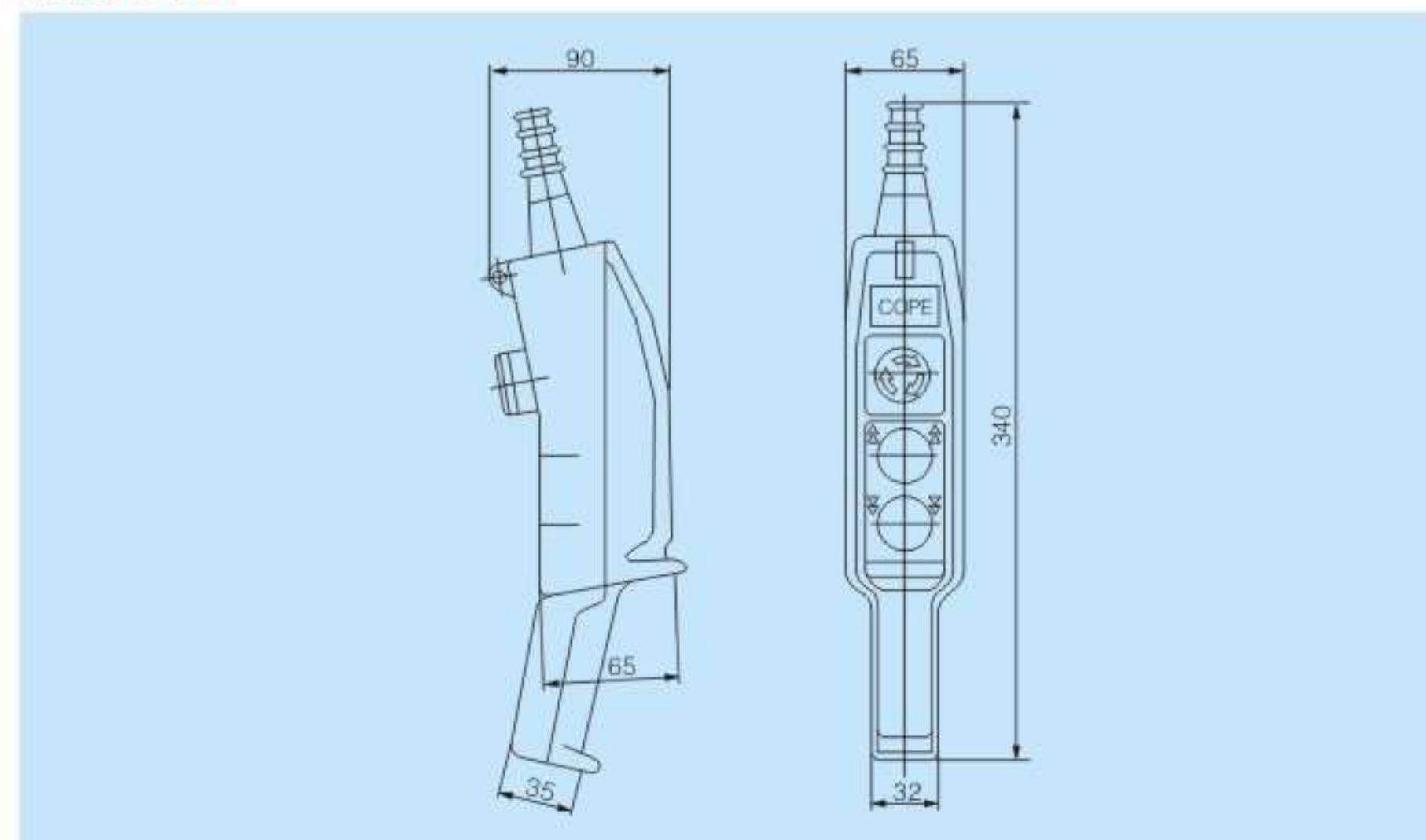

COP(COB)系列防雨型起重机用控制站
COP(COB) Pendant control stations series

间接控制系列

代号	电气原理图	特征	技术参数
COP-6□(P) 动合常开按钮		按钮联锁、自动复位, 是本系列 典型最常用的动合常开按钮	额定电压电流 AC 380V 2A AC 250V 5A 电气寿命100万次
COP-6□A 控制电源开关		ON(开)常开自锁, 由OFF驱动 复位	
COP-6□B 起动停止按钮		按钮一常开一常闭, 自动复位	
COP-2□S 双速按钮		两按钮联锁, 自动复位、与常开触 头比各有一提早, 一滞后动合常 开触头	额定电压380V 持续电流5A 电气寿命10万次
COP-2□K 三极直控 按钮开关		两按钮联锁, 自动复位、 各有三对同时动合的常开触头	
COP-2□ 二极直控 按钮开关		两按钮联锁, 自动复位、一组直 通二队同时动合的常开触头	

该产品符合Q/YDD02-00, JEC.60947-5-1, GB14048.5-2001标准

外形及安装尺寸

序号	a	b	H1	H2	Φ
COP-61	68	50	127	224	12或15
COP-62 Δ			197	308	
COP-63 Δ			257	368	18
COP-64 Δ			317	428	
COP-65 Δ			377	488	
COP-2□Δ	68	70	同COP-6□		

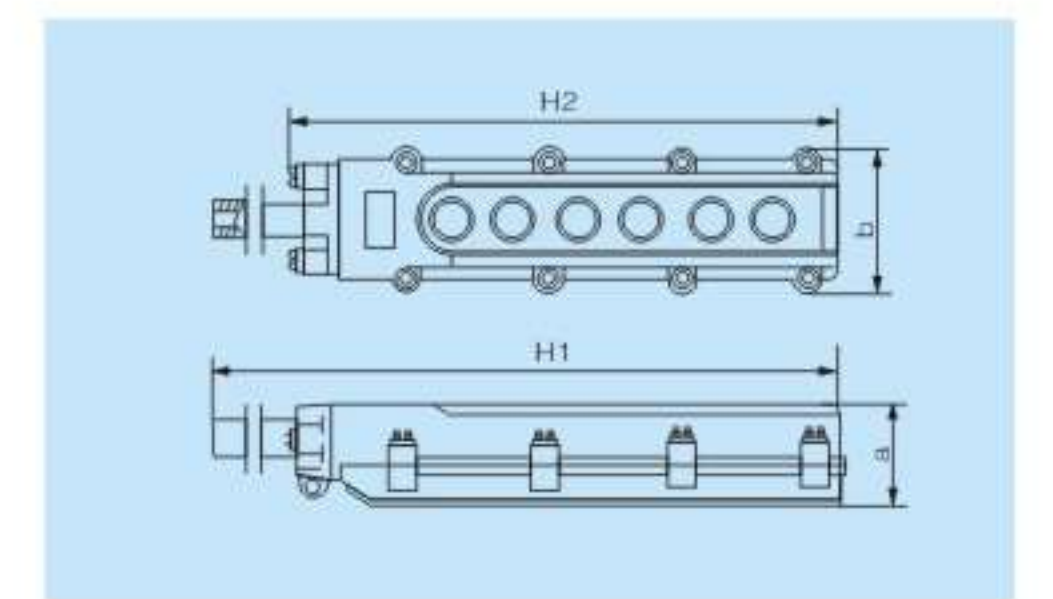

按钮标记

上、下或升、降; 左右或东、西; 前、后; 或南、北; 顺、倒(上)、慢(下), 起动、停止(总停)
方向符号: ◀ ▶ ↻ ↺ ↻ ↺ ◻ ◻ Δ
(双速) ◻ ◻ ◻ ◻ ◻ ◻ (A按钮)
On、OFF; (B按钮或备用按钮) O x

型号及含义

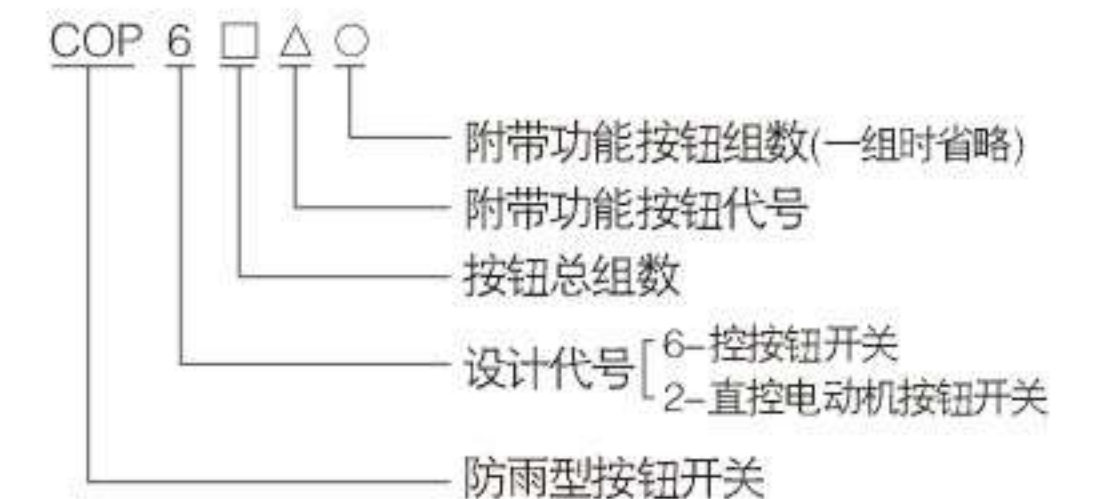

COP系列防雨型起重机用控制站
COP Pendant control stations series



COP-213

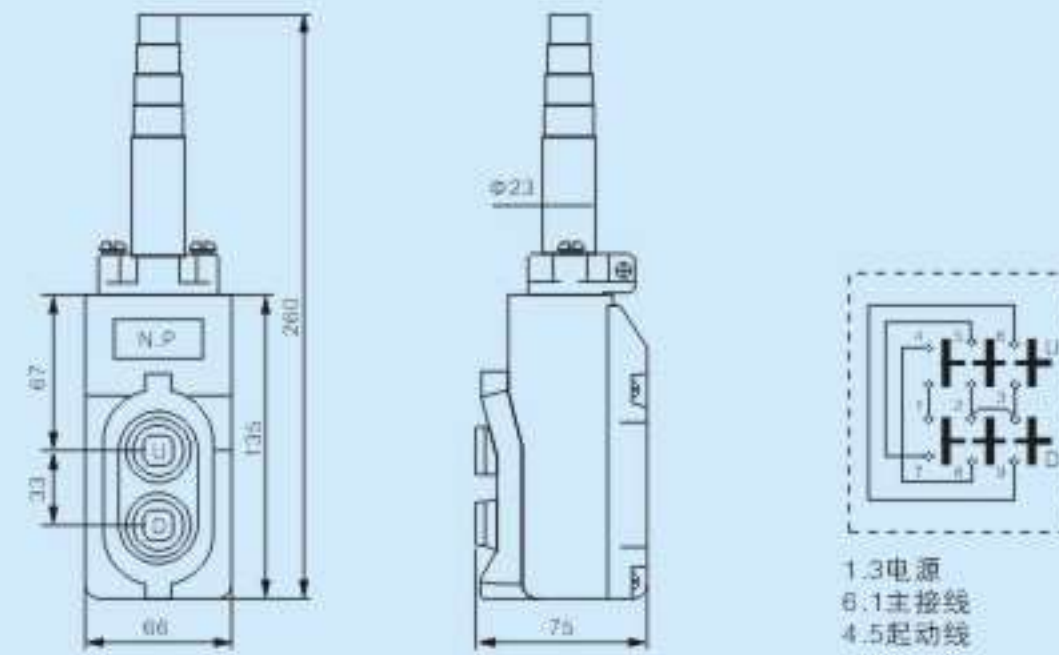

COP-21

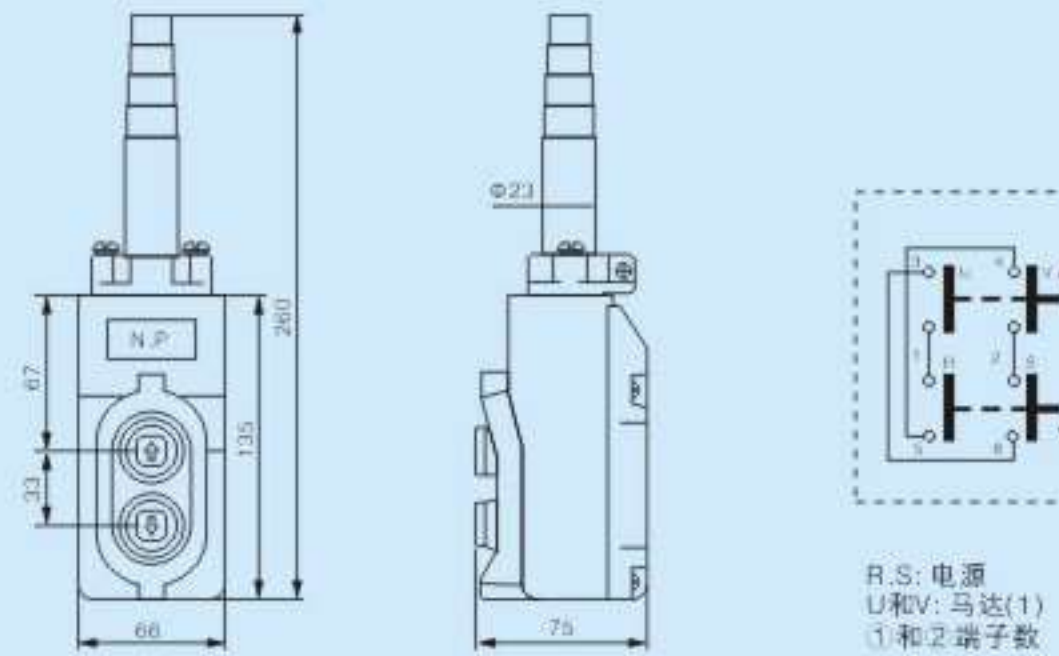

COP-22

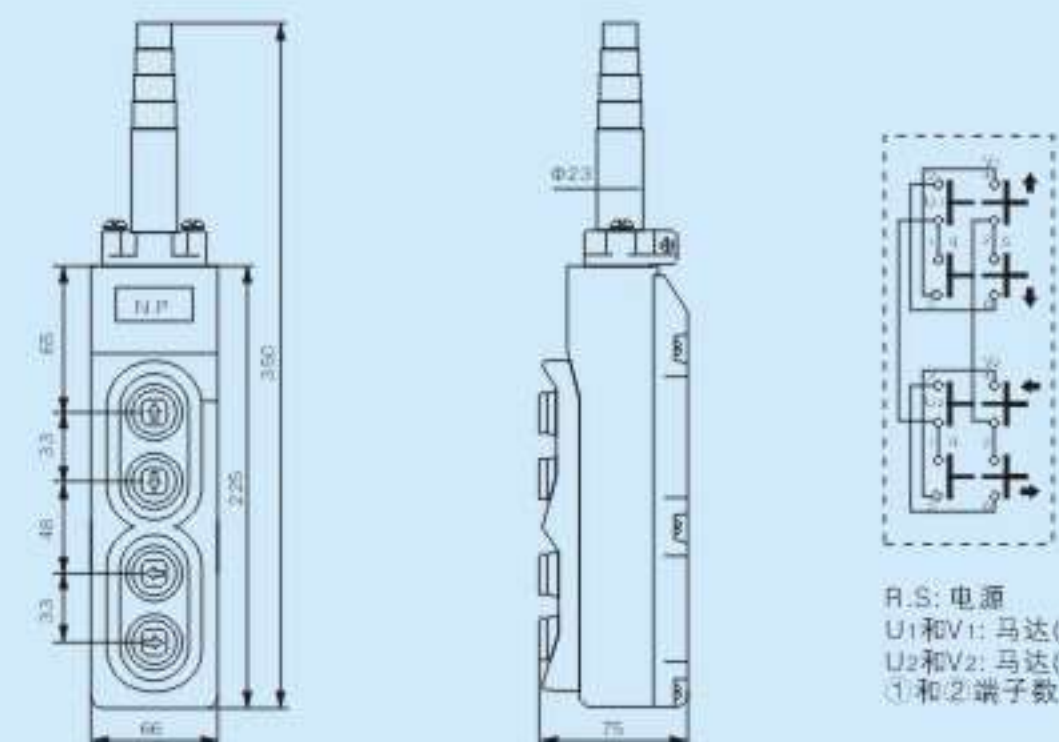

COP-23

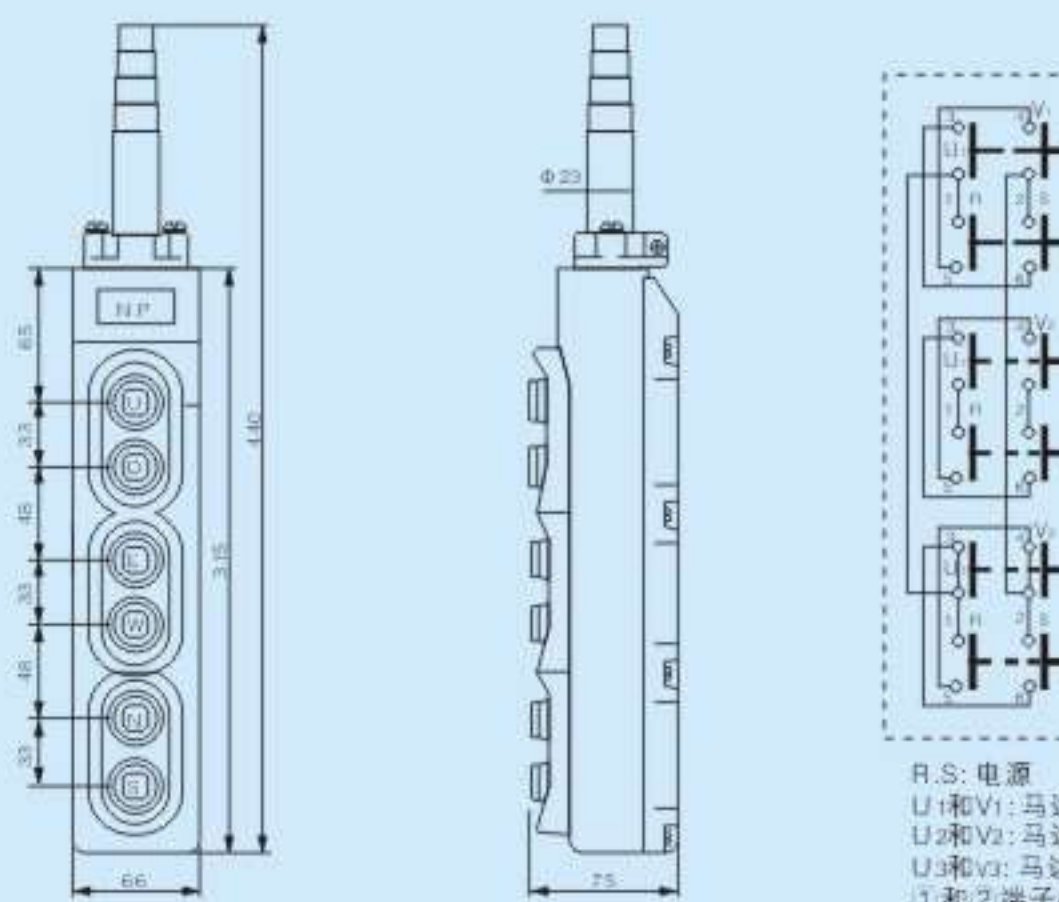

YHLA1(Y090)系列按钮
YHLA1(Y090) Pushbutton series

按钮 Push button	说明 Description	触点类型 Contact type	颜色 Color	型号 Type	外形尺寸 Dimensions
	平台型 Flat roof	1NO 1NC 1NO-1NC 2NO 2NC 2NO-2NC	● Black ● Green ● Red ● Yellow ● Blue ○ White	LBW110E※P LBW101E※P LBW111E※P LBW120E※P LBW102E※P LBW122E※P	
	凸型 Protrusion	1NO 1NC 1NO-1NC 2NO 2NC 2NO-2NC	● Black ● Green ● Red ● Yellow ● Blue ○ White	LBW210E※P LBW201E※P LBW211E※P LBW220E※P LBW202E※P LBW222E※P	
	凸型带全保护 Protrusion with whole protection	1NO 1NC 1NO-1NC 2NO 2NC 2NO-2NC	● Black ● Green ● Red ● Yellow ● Blue ○ White	LBFW210E※P LBFW201E※P LBFW211E※P LBFW220E※P LBFW202E※P LBFW222E※P	
	蘑菇型 Mushroom	1NO 1NC 1NO-1NC 2NO 2NC 2NO-2NC	● Black ● Green ● Red ● Yellow ● Blue ○ White	LBW310E※P LBW301E※P LBW311E※P LBW320E※P LBW302E※P LBW322E※P	
	蘑菇型 Mushroom	1NO 1NC 1NO-1NC 2NO 2NC 2NO-2NC	● Black ● Green ● Red ● Yellow ● Blue ○ White	LBW410E※P LBW401E※P LBW411E※P LBW420E※P LBW402E※P LBW422E※P	
	蘑菇型带全保护 Mushroom with whole protection	1NO 1NC 1NO-1NC 2NO 2NC 2NO-2NC	● Black ● Green ● Red ● Yellow ● Blue ○ White	LBGW410E※P LBGW401E※P LBGW411E※P LBGW420E※P LBGW402E※P LBGW422E※P	



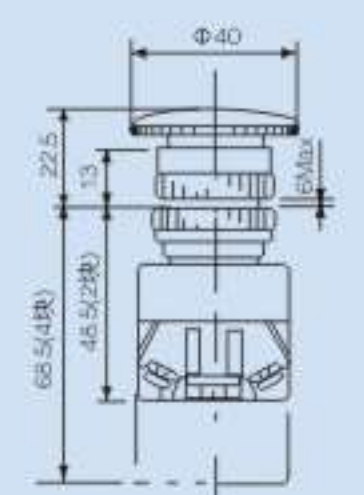





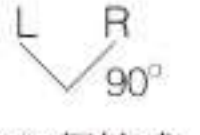
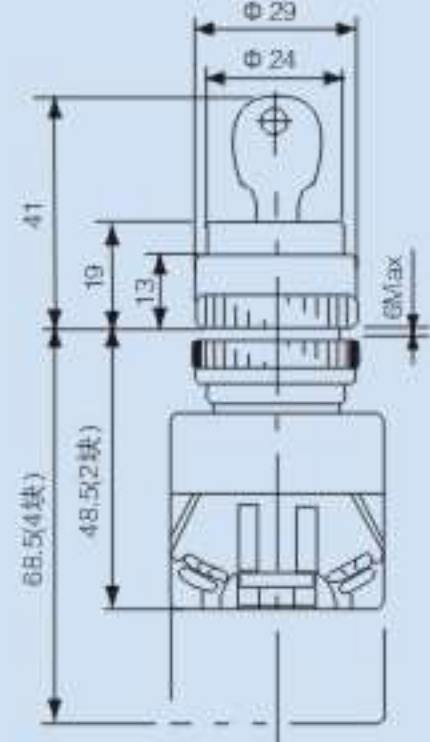

YHLA1(Y090)系列按钮
YHLA1(Y090) Pushbutton series

按钮 Push button	说明 Description	触点类型 Contact type	颜色 Color	型号 Type	外形尺寸 Dimensions
	方平台型 Squareness flat roof	1NO 1NC 1NO-1NC 2NO 2NC 2NO-2NC	● Black ● Green ● Red ● Yellow ● Blue ○ White	LBQW110E※P LBQW101E※P LBQW111E※P LBQW120E※P LBQW102E※P LBQW122E※P	
	按锁定转复位	1NO 1NC 1NO-1NC 2NO 2NC 2NO-2NC	● Red $\Phi 29$	LWV310EPR LWV301EPR LWV311EPR LWV320EPR LWV302EPR LWV322EPR	
	按锁定转复位	1NO 1NC 1NO-1NC 2NO 2NC 2NO-2NC	● Red $\Phi 40$	LWV410EPR LWV401EPR LWV411EPR LWV420EPR LWV402EPR LWV422EPR	
	按锁定钥匙 转复位	1NO 1NC 1NO-1NC 2NO 2NC 2NO-2NC	● Red $\Phi 29$	LXW310EPR LXW301EPR LXW311EPR LXW320EPR LXW302EPR LXW322EPR	
	按锁定钥匙 转复位	1NO 1NC 1NO-1NC 2NO 2NC 2NO-2NC	● Red $\Phi 40$	LXW410EPR LXW401EPR LXW411EPR LXW420EPR LXW402EPR LXW422EPR	

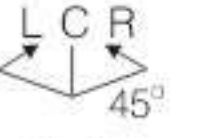

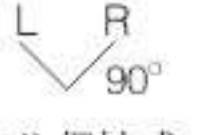
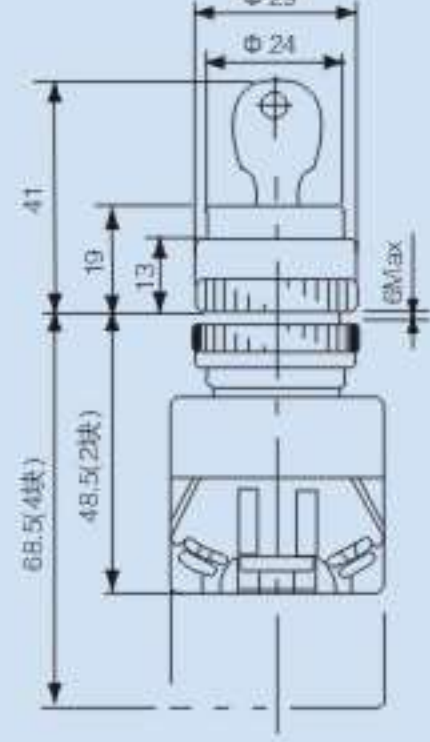

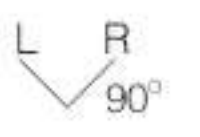
YHLA1(Y090)系列照明按钮
YHLA1(Y090) Pushbutton series

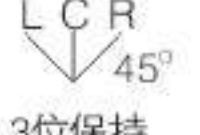
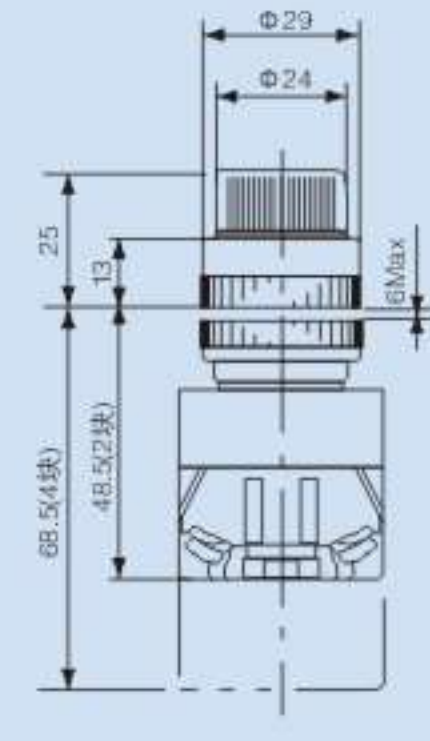
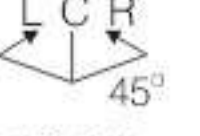
按钮 Push button	说明 Protrusion	输入类型 Input type	触点类型 Contact type	颜色 Color	型号 Type	外形尺寸 Dimensions
	凸型 LED照明 Protrusion	变压器式 Transformer 直接式 Directly	1NO-1NC 2NO 1NO-1NC 2NO 1NO-1NC 2NO	● Red ● Yellow ● Green ● Blue ○ Red	LLW2□11DE※P LLW2□20DE※P LLW29911DE※P LLW29920DE※P LOLW2□11DE※P LOLW2□20DE※P LOLW29911DE※P LOLW29920DE※P	
	凸型 白炽灯照明 Protrusion	变压器式 Transformer 直接式 Directly	1NO-1NC 2NO 1NO-1NC 2NO 1NO-1NC 2NO	● Red ● Yellow ● Green ● Blue ○ Red	LLW2□11E※P LLW2□20E※P LLW29911E※P LLW29920E※P LOLW2□11E※P LOLW2□20E※P LOLW29911E※P LOLW29920E※P	
	凸型带全保护套 LED照明 Protrusion with whole protection	变压器式 Transformer 直接式 Directly	1NO-1NC 2NO 1NO-1NC 2NO	● Red ● Yellow ● Green ● Blue ○ Red	LLFW2□11DE※P LLFW2□20DE※P LLFW29911DE※P LLFW29920DE※P	
	凸型带全保护套 白炽灯照明 Protrusion with whole protection	变压器式 Transformer 直接式 Directly	1NO-1NC 2NO 1NO-1NC 2NO	● Red ● Yellow ● Green ● Blue ○ Red	LLFW2□11E※P LLFW2□20E※P LLFW29911E※P LLFW29920E※P	
	凸型带变压器 白炽灯照明 Protrusion with transformer	变压器式 Transformer	1NO-1NC	● Red ● Yellow ● Green ● Blue ○ Red	LLW2□11E※P	
	蘑菇型 LED照明 Mushroom	直接式 Directly	1NO-1NC	● Red ● Yellow ● Green ● Blue ○ Red	LLW499DE※P	
	蘑菇型 白炽灯照明 Mushroom	直接式 Directly	1NO-1NC	● Red	LLW49911E※P	
	按锁定、转复位 LED照明 Mushroom	直接式 Directly	1NO-1NC	● Red	LVLW49911DEPR	
	按锁定、转复位 白炽灯照明 Mushroom	直接式 Directly	1NO-1NC	● Red	LVLW49911EPR	

YHLA1(Y090) 钥匙选择钮 YHLA1(Y090) Pushbutton series

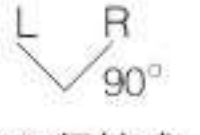
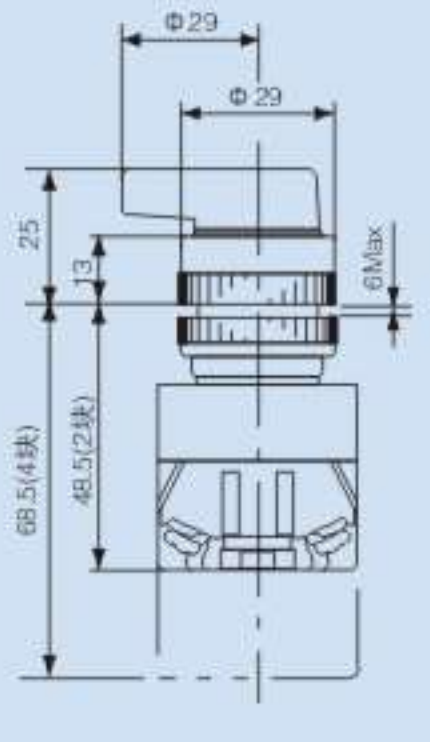
按钮 Push button	说明 Protusion	触点类型 Contact type	位置 Locality	型号 Type	外形尺寸 Dimensions
	钥匙型 Key	1NO(10) 1NO-1NC(11) 2NO(20) 2NO-2NC(22)	 2位保持式	LSW2K10EP LSW2K11EP LSW2K20EP LSW2K22EP	
	钥匙型 Key	2NO(20)	 3位保持	LSW3K20EP	
	钥匙型 Key	2NO(20)	 3位自复	LSW33K20EP	
	钥匙型 Key	1NO(10) 1NO-1NC(11) 2NO-20NC 2NO-2NC(22)	 2位保持式	LSW2K10EP LSW2K11EP LSW2K20EP LSW2K22EP	
	旋钮式 Eddy	1NO(10) 1NO-1NC(11) 2NO-20NC 2NO-2NC(22)	 2位保持式	LSW210EP LSW211EP LSW220EP LSW222EP	
	旋钮式 Eddy	2NO(20)	 3位保持	LSW320EP	
			 3位自复	LSW3320EP	









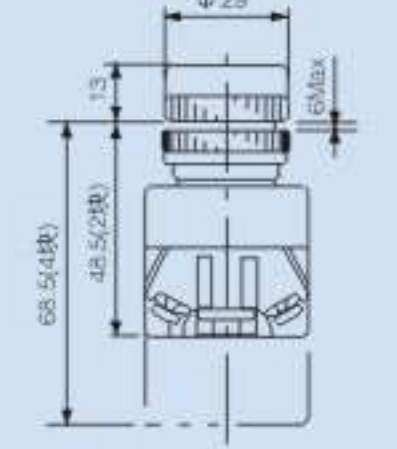

YHLA1(Y090) 钥匙选择钮 YHLA1(Y090) Pushbutton series

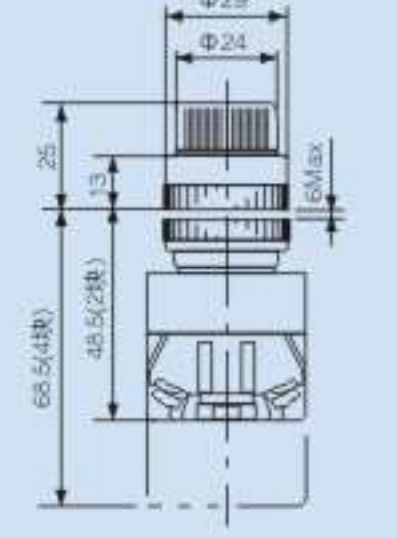
按钮 Push button	说明 Description	触点类型 Contact type	位置 Locality	型号 Type	外形尺寸 Dimensions
	杆式 Pole	1NO(10) 1NO-1NC(11) 2NO-20NC 2NO-2NC(22)	 2位保持式	LSW2L10EP LSW2L11EP LSW2L20EP LSW2L22EP	
	杆式 Pole	2NO(20)	 3位保持	LSW3L20EP LSW3L22EP	
		2NO-2NC(22)	 3位自复	LSW33L20EP LSW33L22EP	

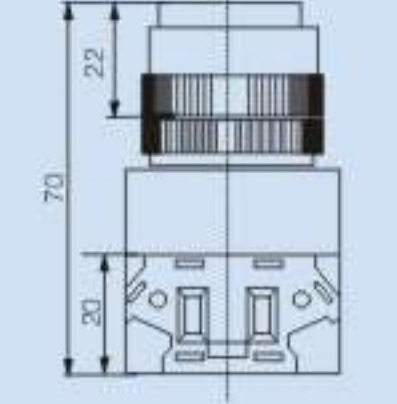

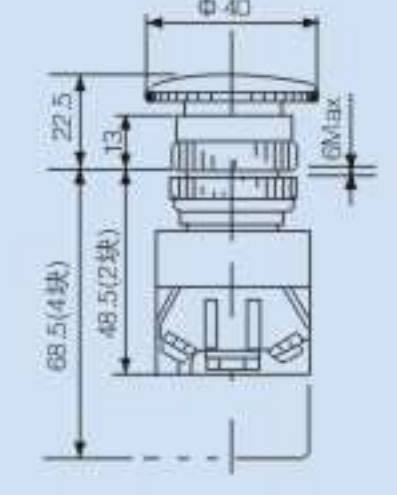

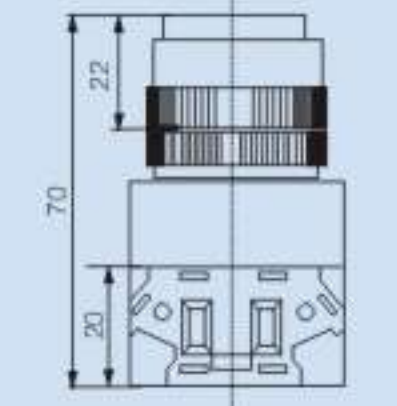

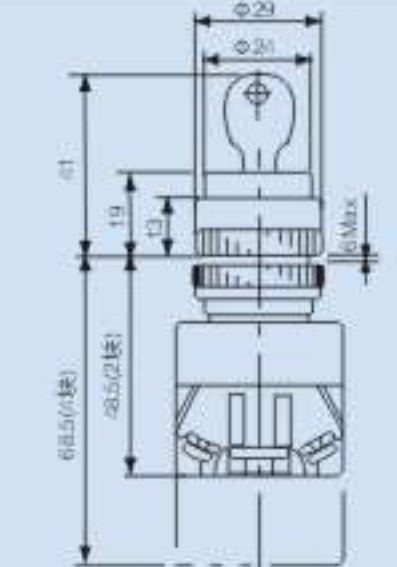

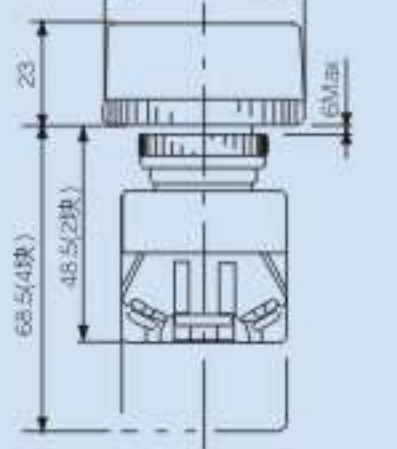

指示灯

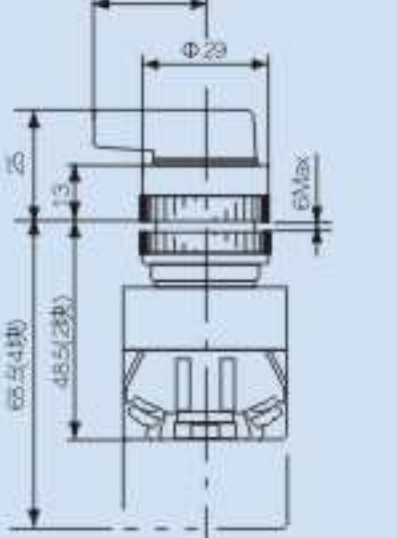
按钮 Push button	说明 Description	输入类型 Input type	颜色 Color	型号 Type	外形尺寸 Dimensions
	LED	变压器式 Transformer	● Red	LPW1□6DE※P	
		直接式 Directly	● Yellow ● Green	LPW199DE※P	
	白炽灯	变压器式 Transformer	● Blue	LPW1□6E※P	
		直接式 Directly	○ Red	LPW199E※P	
平台型	LED	变压器式 Transformer	● Red	LPW1B□6DE※P	
		直接式 Directly	● Yellow ● Green	LPW1B99DE※P	
	白炽灯	变压器式 Transformer	● Blue	LPW1B□6E※P	
		直接式 Directly	○ Red	LPW1B99E※P	
圆顶型	LED	变压器式 Transformer	● Red	LPW2□6DE※P	
		直接式 Directly	● Yellow ● Green	LPW299DE※P	
	白炽灯	变压器式 Transformer	● Blue	LPW2□6E※P	
		直接式 Directly	○ Red	LPW299E※P	

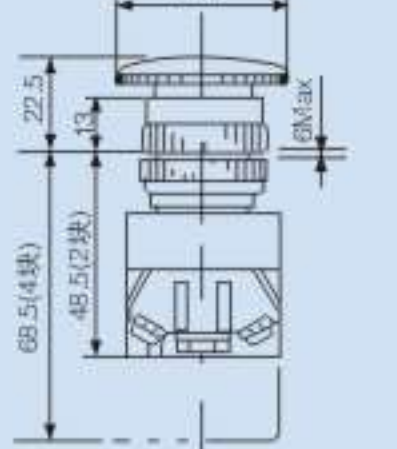

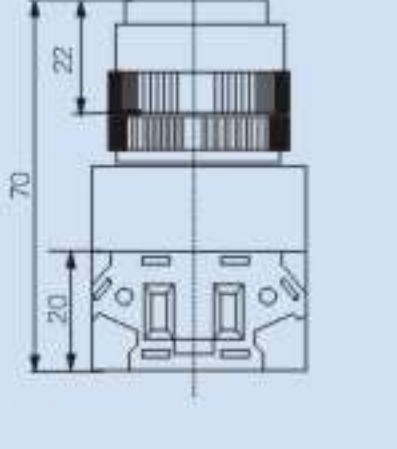

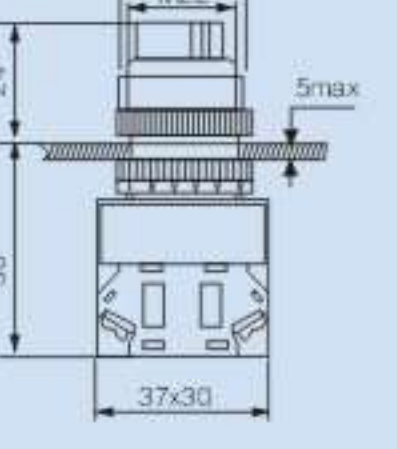

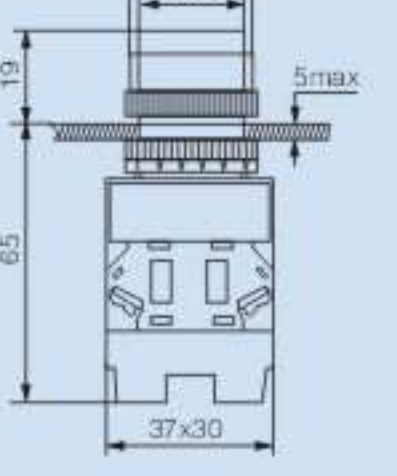

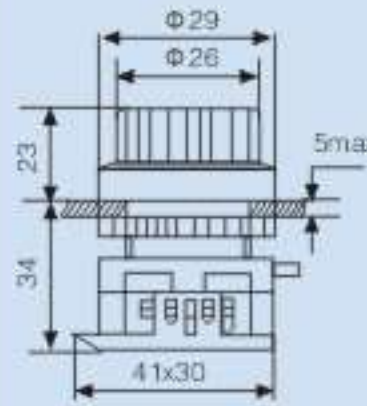

YHLA1(LAY90/Y090)系列按钮
YHLA1(LAY90/Y090) Pushbutton series

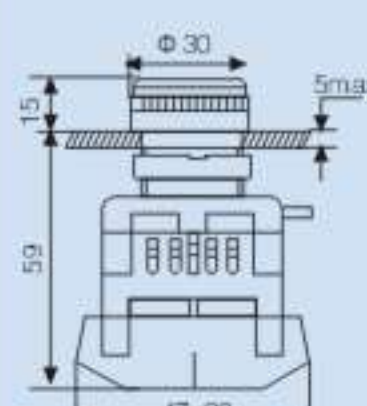
按钮 Push button	说明 Description	功能 Function	颜色 Color	型号 Type	外形尺寸 Dimensions
	普通按钮 Normal	瞬时型 Momentary	● Black ● Green ● Red	YHLA1-11BN	
	自锁按钮 Lockrd itself	交替型 Alternate	● Yellow ● Blue ○ White	YHLA1-11BNZS	
	二位旋钮开关 Two level gyal buttons	交替型 Alternate	● Black ● Green ● Red	YHLA1-11X/21	
	二位自复旋钮开关 Two level gyal buttons and resumed itself	瞬时型 Momentary	● Yellow	YHLA1-20X/22	
	带灯按钮 With lamp	瞬时型 Momentary	● Green ● Red ● Yellow	YHLA1-11D	
	带灯自锁按钮 Locked itself with lamp	交替型 Alternate	● Blue ○ White	YHLA1-11DZS	
	紧急按钮 Stopped urgently	旋转复位型 Rotating And Reset	● Green ● Red ● Yellow	YHLA1-11ZS	
	高位按钮 Ligh level	瞬时型 Momentary	● Black ● Green ● Red	YHLA1-11GN	
	高位自锁 Ligh level and locked itself	交替型 Alternate	● Yellow ○ White	YHLA1-11GNZS	
	二位钥匙开关 Two level key buttons	交替型 Alternate		YHLA1-11Y/21	
	三位钥匙开关 Three level key buttons	交替型 Alternate		YHLA1-11Y/31	

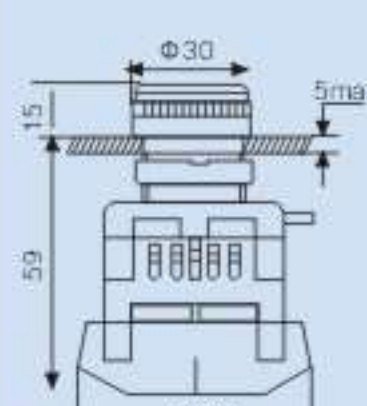

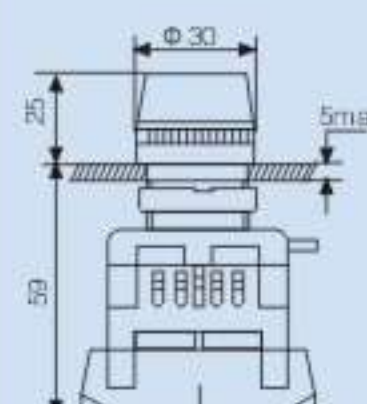

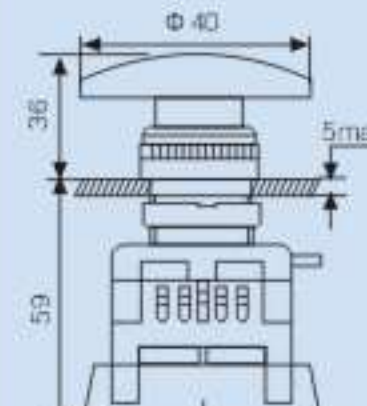

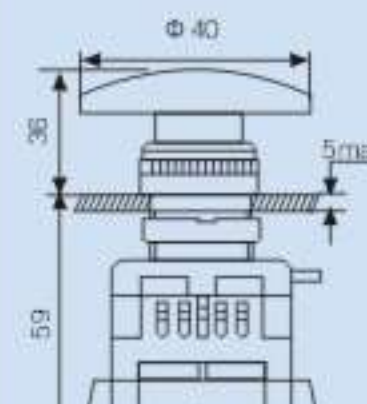

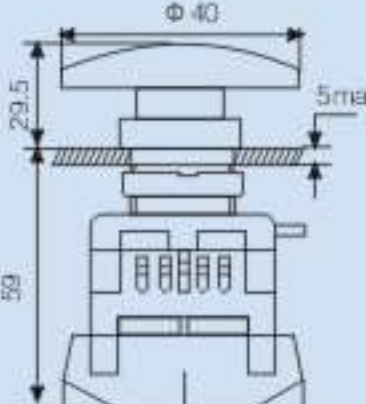

YHLA1(LAY90/Y090)系列按钮
YHLA1(LAY90/Y090) Pushbutton series

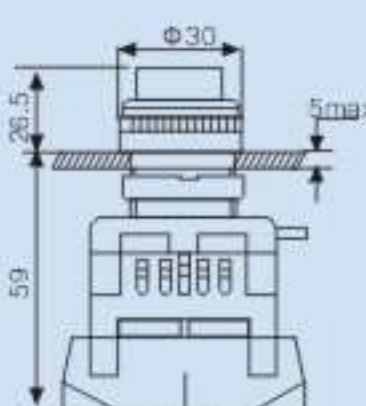
按钮 Push button	说明 Description	功能 Function	颜色 Color	型号 Type	外形尺寸 Dimensions
	蘑菇头按钮 Mushroom head	瞬时型 Momentary	● Green ● Red ● Yellow	YHLA1-11M	
	三位旋钮开关 Three level gyal buttons	交替型 Alternate	● Black	YHLA1-11XB/31	
	三位自复旋钮开关 Three level gyal buttons and resumed itself	瞬时型 Momentary	● Green ● Red ● Yellow	YHLA1-20XB/33	
	三位半复位开关 Three level gyal buttons and resumed half itself	交替瞬时型 Alternate and Momentary		YHLA1-20XB/32	
	蘑菇头带灯按钮 Mushroom head with lamp	瞬时型 Momentary	● Green ● Red ● Yellow	YHLA1-11DM	
	蘑菇头带灯自锁按钮 Mushroom head with lamp and locked itself	交替型 Alternate		YHLA1-11DMZS	
	信号灯 Signal lamp	旋转复位型 Rotating And Reset	● Green ● Red ● Yellow ● Blue ○ White	YHLA-XD(SLC)	
	二位旋钮带灯 Two level gyal buttons	交替型 Alternate	● Green ● Red ● Yellow	YHLA1-11XD/21	
	三位旋钮带灯 Three level gyal buttons	交替型 Alternate		YHLA1-11XD/31	
	平型带灯按钮 Flat floor with lamp	瞬时型 Momentary	● Green ● Red ● Yellow	YHLA1-11DB	
	平型带灯自锁按钮 Flat floor with lamp and locked itself	交替型 Alternate	● Blue ○ White	YHLA1-11DBNBS	

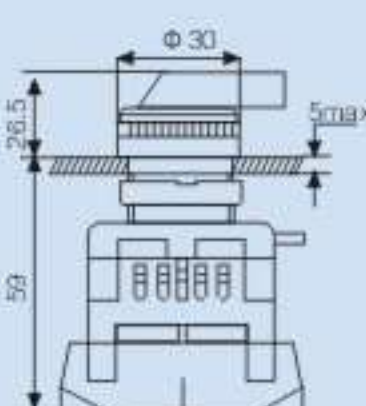

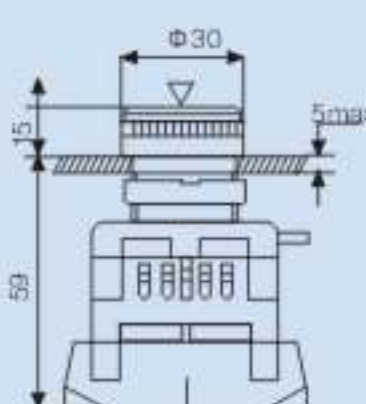

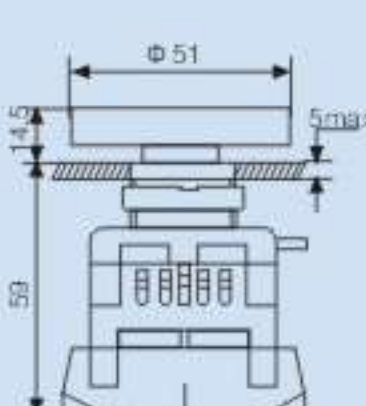

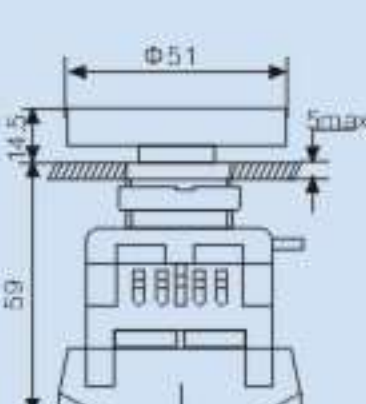

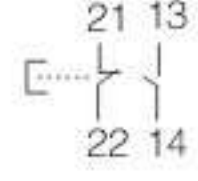
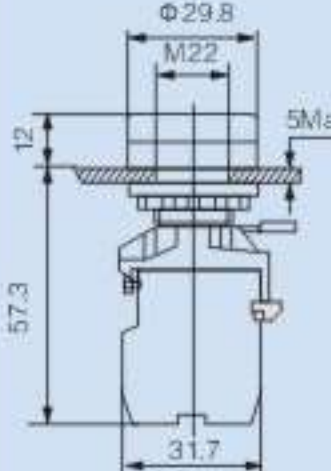

A 系列按钮
A Pushbutton series

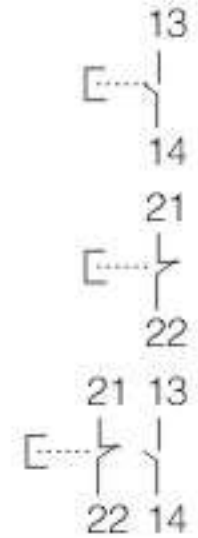
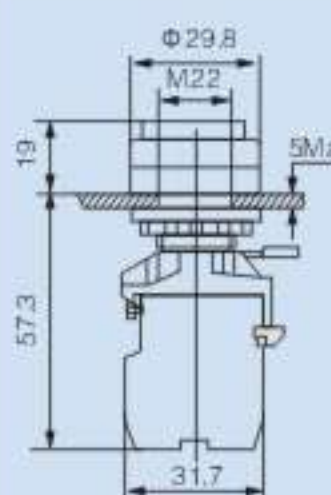
按钮 Push button	说明 Description	触点类型 Contact type	电路 Circuit	颜色 Color	型号 Type	外形尺寸 Dimensions
	指示灯 Indicator BA 9S LED 24V/AC/DC Neon 220V/AC		X1 X1 X2 X2	Red Green/PG Yellow White/PW Pure Blue	AL-22TE	
	平钮 Flush button 22&25 Auto-return	N/O+N/C	21 13 22 14	Red Green/PG Yellow White/PW Pure Blue	ABF-22&25 ABF-22&25	
	带灯平钮 Flush button with lamp LED 24V/AC/DC Neon 220V/AC 22&25	N/O+N/C	X1 X1 X2 X2 21 13 22 14	Red Green/PG Yellow White/PW Pure Blue	AELFS-22&25 AELFSL-22&25	
	带灯凸钮 Convex button with lamp BA9S LED 24V/AC/DC Neon 220V/AC	N/O+N/C	X1 X1 X2 X2 21 13 22 14	Red Green/PG Yellow White/PW Pure Blue	AELF-22&25 AELFL-22&25	
	蘑菇钮 Mushroom button 22&25 Auto-return	N/O+N/C	21 13 22 14	Red Green/PG Yellow White/PW Pure Blue	AEA-22&25 AEAL-22&25	
	带灯蘑菇钮 Mushroom button with lamp BA9S LED 24V/AC/DC Neon 220V/AC 22&25	N/O+N/C	X1 X1 X2 X2 21 13 22 14	Red Green/PG Yellow White/PW Pure Blue	AELA-22&25 AELAL-22&25	

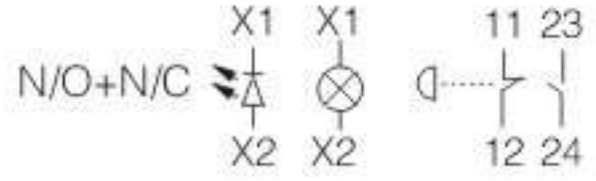
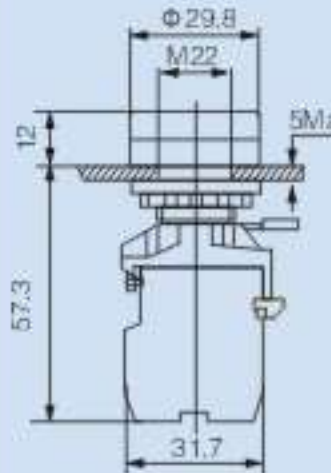

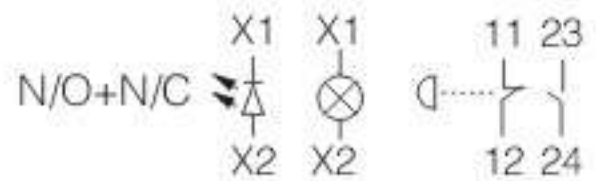
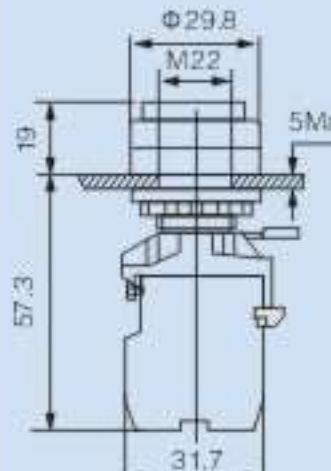

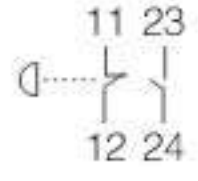
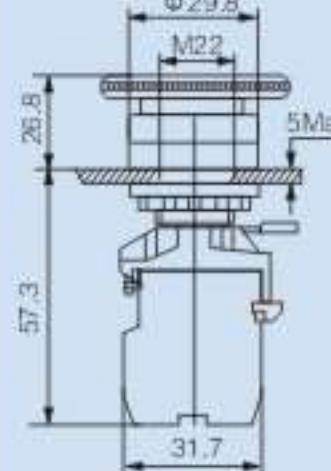

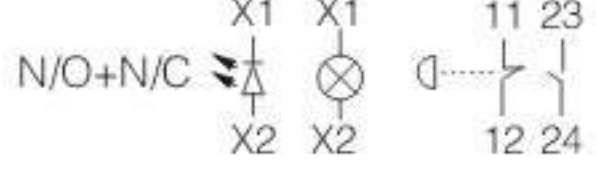
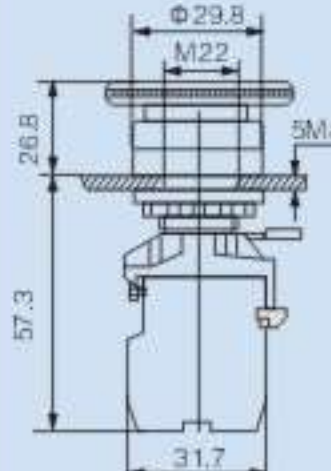

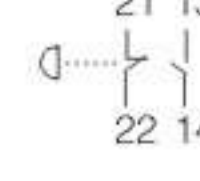
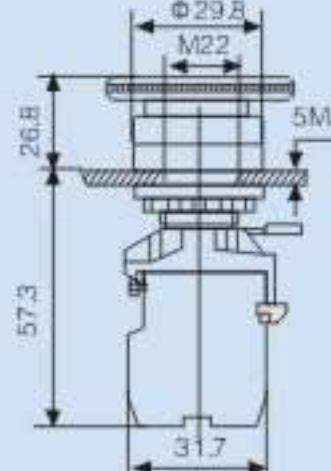

A 系列按钮
A Pushbutton series

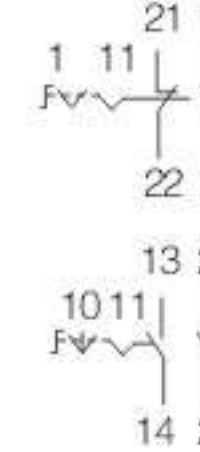
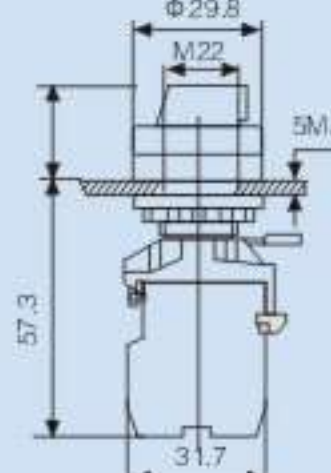
按钮 Push button	说明 Description	触点类型 Contact type	电路 Circuit	颜色 Color	型号 Type	外形尺寸 Dimensions
	自锁蘑菇钮 Auto-locking mushroom Emergency push button push then locking rotary in a clockwise direction to release 22&25	N/O+N/C	21 13 22 14	Red	AE-22&25	
	选择开关 selector switch with lamp standard handle 22&25	N/O+N/C	X1 X1 X2 X2 21 13 22 14 10 11 13 23 14 24	Red Green/PG Yellow	ANC-22&25	
	长柄选择开关 selector switch two-position switch long handle three-position 22&25	N/O+N/C N/O+N/O	21 13 1 11 22 14 10 11 13 23 14 24	Red Green/PG Yellow Black	ALC-22&25	
	选择自锁开关 Two-position switch selector switch with key key release (key n° 455) three-position switch	N/O+N/C	21 13 1 11 22 14	Null	AKS-22&25	
	双头按钮开关 One green and one red pushbutton marked one pilot light with yellow lens 220/250V BA9S 130V bulb included 22&25 IP40	N/O+N/C	X1 X1 X2 X2 13 14 21 22	Red O off Yellow Green I on	AS-22&25	
	双头按钮开关 One green and one red pushbutton marked one pilot light with yellow lens 220/250V BA9S 130V bulb included 22&25 IP40	N/O+N/C	X1 X1 X2 X2 13 14 21 22	Red O off Yellow Green I on	APBB-22&25	

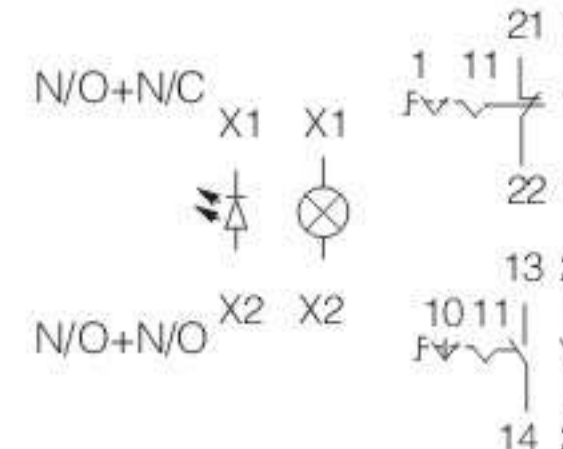
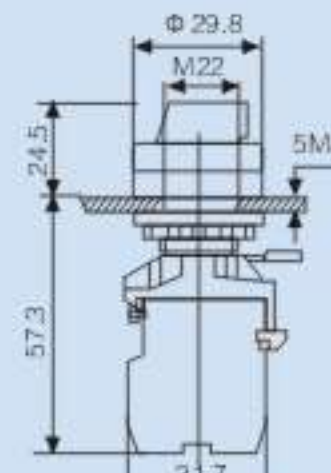
LA42 系列按钮
LA42 Pushbutton series

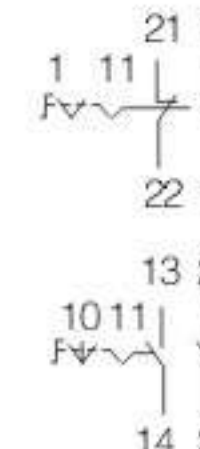
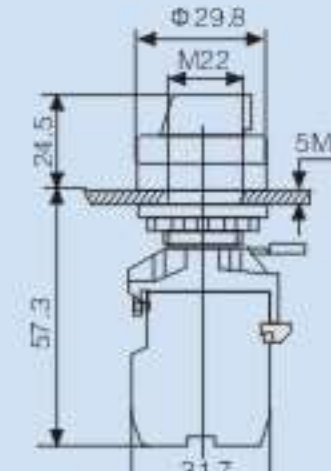
按钮 Push button	说明 Description	触点类型 Contact type	电路 Circuit	颜色 Color	型号 Type	外形尺寸 Dimensions
	平钮 Flush button Auto-return Auto-locking	N/O+N/C		● Red ● Green/PG ● Yellow ○ White/PW ● Pure Blue	LA42-11BN LA42-11BNZ	
	凸钮 Convex button Auto-return Auto-locking	N/O N/C N/O+N/C		● Red ● Green/PG ● Yellow ○ White/PW ● Pure Blue	LA42-01GN LA42-01GNZ LA42-10GN LA42-10GNZ LA42-11GN LA42-11GNZ	
	带灯平钮 Flush button with lamp LED 24V/AC/DC Neon 220V/AC	N/O+N/C		● Red ● Green/PG ● Yellow ○ White/PW ● Pure Blue	LA42-11BND LA42-11BNDZ	
	带灯凸钮 Convex button with lamp LED 24V/AC/DC Neon 220V/AC Convex button Auto-locking with lamp	N/O+N/C		● Red ● Green/PG ● Yellow ○ White/PW ● Pure Blue	LA42-11GND LA42-11GNDZ	
	蘑菇钮 Mushroom button Auto-return Auto-locking mushroom	N/O+N/C		● Red ● Green/PG ● Yellow ○ White/PW ● Pure Blue	LA42-11M LA42-11MZ	
	带灯蘑菇钮 Mushroom button with lamp BA9S LED 24V/AC/DC Neon 220V/AC Auto-locking mushroom with lamp	N/O+N/C		● Red ● Green/PG ● Yellow ○ White/PW ● Pure Blue	LA42-11MD LA42-11MDZ	

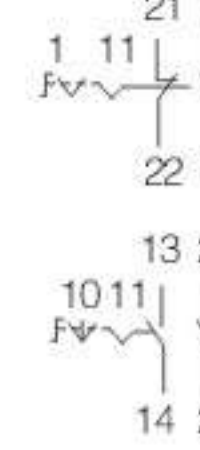
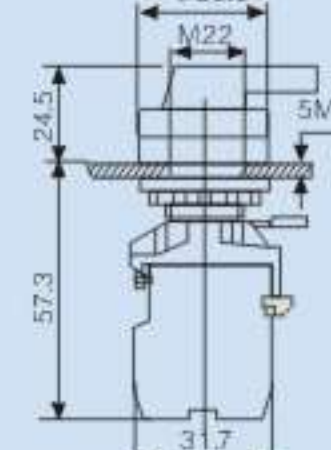

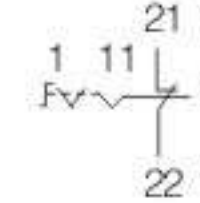
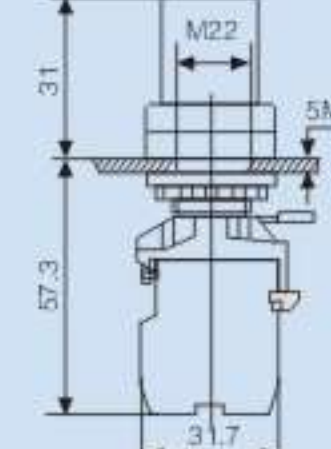



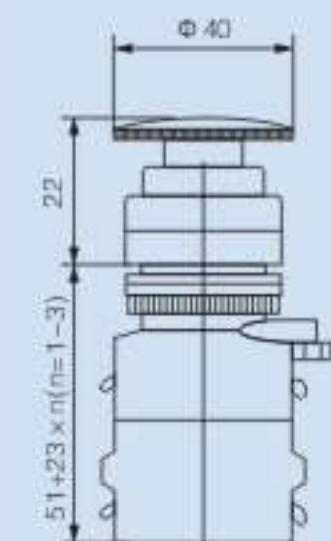

LA42 系列按钮
LA42 Pushbutton series

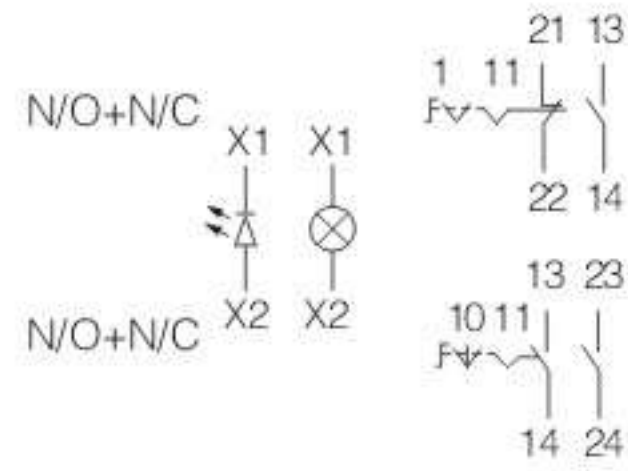
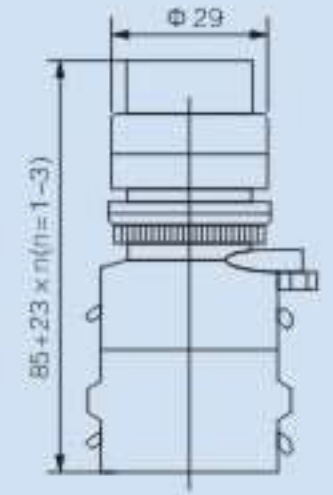
按钮 Push button	说明 Description	触点类型 Contact type	电路 Circuit	颜色 Color	型号 Type	外形尺寸 Dimensions
	自锁蘑菇钮 Auto-locking Mushroom Emergency push button push then locking rotary om a c,pckwise dorection to release	N/O+N/C		● Red	LA42-11ZS	
	选择开关 selector switch two-position switch three-position switch standard handle	N/O+N/C N/O+N/O		● Red ● Black	LA42-11X/21 LA42-11X/31 LA42-20X/31 LA42-20X/32	
	选择开关 selector switch with lamp standard handle three-position switch	N/O+N/C N/O+N/O		● Red ● Green/PG ● Yellow	LA42-11XD/21 LA42-11XD/31 LA42-20XD/31 LA42-20XD/32	
	选择开关 selector switch with lamp standard handle three-position switch	N/O+N/C N/O+N/O		● Red ● Green/PG ● Yellow	LA42-11XD/31 LA42-11XD/32	
	选择自锁开关 Two-position selector switch long handle three-position switch	N/O+N/C N/O+N/O		● Black	LA42-11XB/21 LA42-11XB/31 LA42-20XB/32	
	手动旋钮开关 Two-rotary switch by hand	N/O+N/C		● Black	LA42-11RX/21	

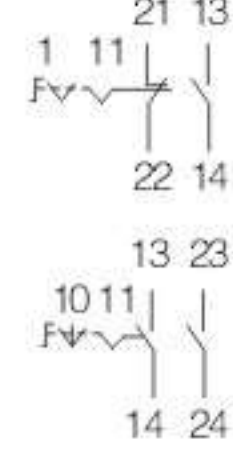
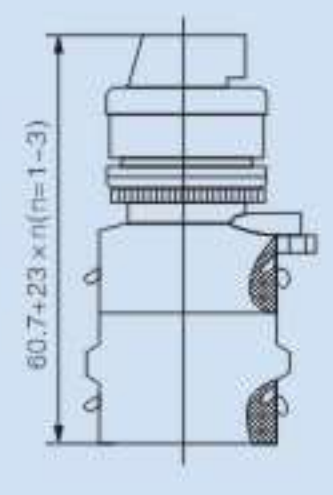
LA38 系列按钮
LA38 Pushbutton series

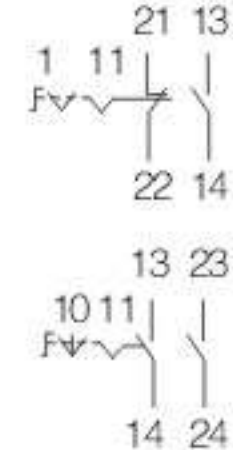
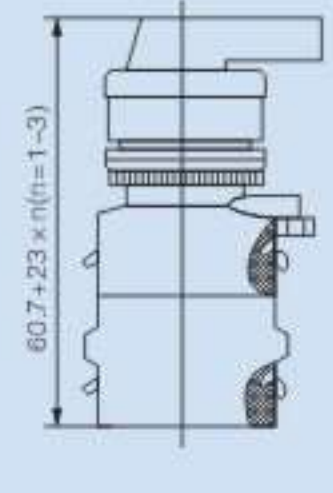
按钮 Push button	说明 Description	触点类型 Contact type	电路 Circuit	颜色 Color	型号 Type	外形尺寸 Dimensions
	平钮 Flush button Auto-return Auto-locking	N/O+N/C		<ul style="list-style-type: none"> ● Red ● Green ● Yellow ○ White ● Blue ● Black 	LA38-11 LA38-11Z	
LA38-11						
	蘑菇钮 Mushroom button Auto-return Auto-locking mushroom	N/O+N/C		<ul style="list-style-type: none"> ● Red ● Green/PG ● Yellow 	LA38-11M	
LA38-11M						
	带灯平钮 Flush button with lamp 6~380V	N/O+N/C		<ul style="list-style-type: none"> ● Red ● Green/PG ● Yellow 	LA38-11D LA38-11DZ	
LA38-11D						
	带灯蘑菇钮 Mushroom button with lamp 6~380V	N/O+N/C		<ul style="list-style-type: none"> ● Red ● Green/PG ● Yellow 	LA38-11MD LA38-11MDZ	
LA38-11MD						
	自锁蘑菇钮 Auto-locking mushroom Emergency push button push then locking rotary in a clockwise direction to release	N/O+N/C		<ul style="list-style-type: none"> ● Red 	LA38-11ZS	
LA38-11ZS						

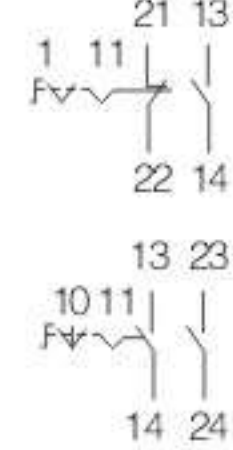
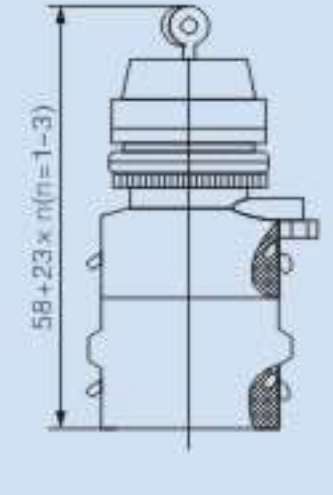
LA38 系列按钮
LA38 Pushbutton series

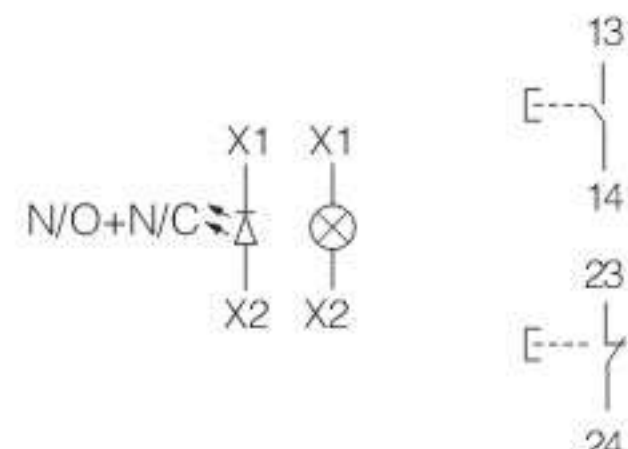
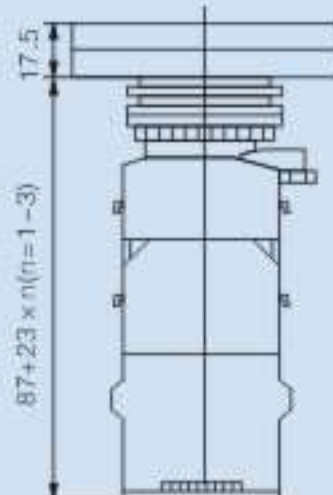
按钮 Push button	说明 Description	触点类型 Contact type	电路 Circuit	颜色 Color	型号 Type	外形尺寸 Dimensions
	选择开关 selector switch with lamp standard handle two-position switch	N/O+N/C		<ul style="list-style-type: none"> ● Red ● Green/PG ● Yellow 	LA38-11XD/21 LA38-11XD/31	
LA38-11XD						
	选择开关 Selector switch two-position switch three-position switch standard handle	N/O+N/C		<ul style="list-style-type: none"> L C R 	LA38-11X/21 LA38-11X/31	
LA38-11X						
	选择开关 Selector switch two-position switch three-position switch long handle	N/O+N/C		<ul style="list-style-type: none"> L C R 	LA38-11XB/21 LA38-11XB/31	
LA38-11XB						
	钥匙开关 Two-position switch selector switch with key key release (key n° 455) three-position switch	N/O+N/C		<ul style="list-style-type: none"> L C R 	LA38-11Y/21 LA38-11Y/31	
LA38-11Y						
	双头按钮开关 One green and one red pushbutton marked one pilot light with yellow lens 220/250V BA9S 130V bulb included 22&25 IP40	N/O+N/C		<ul style="list-style-type: none"> ● Red O off ● Yellow ● Green I on 	LA38-11H LA38-11HD	
LA38-11HD						

YHJ 金属按钮系列 YHJ Metal switch series

型号含义 Models and meaning

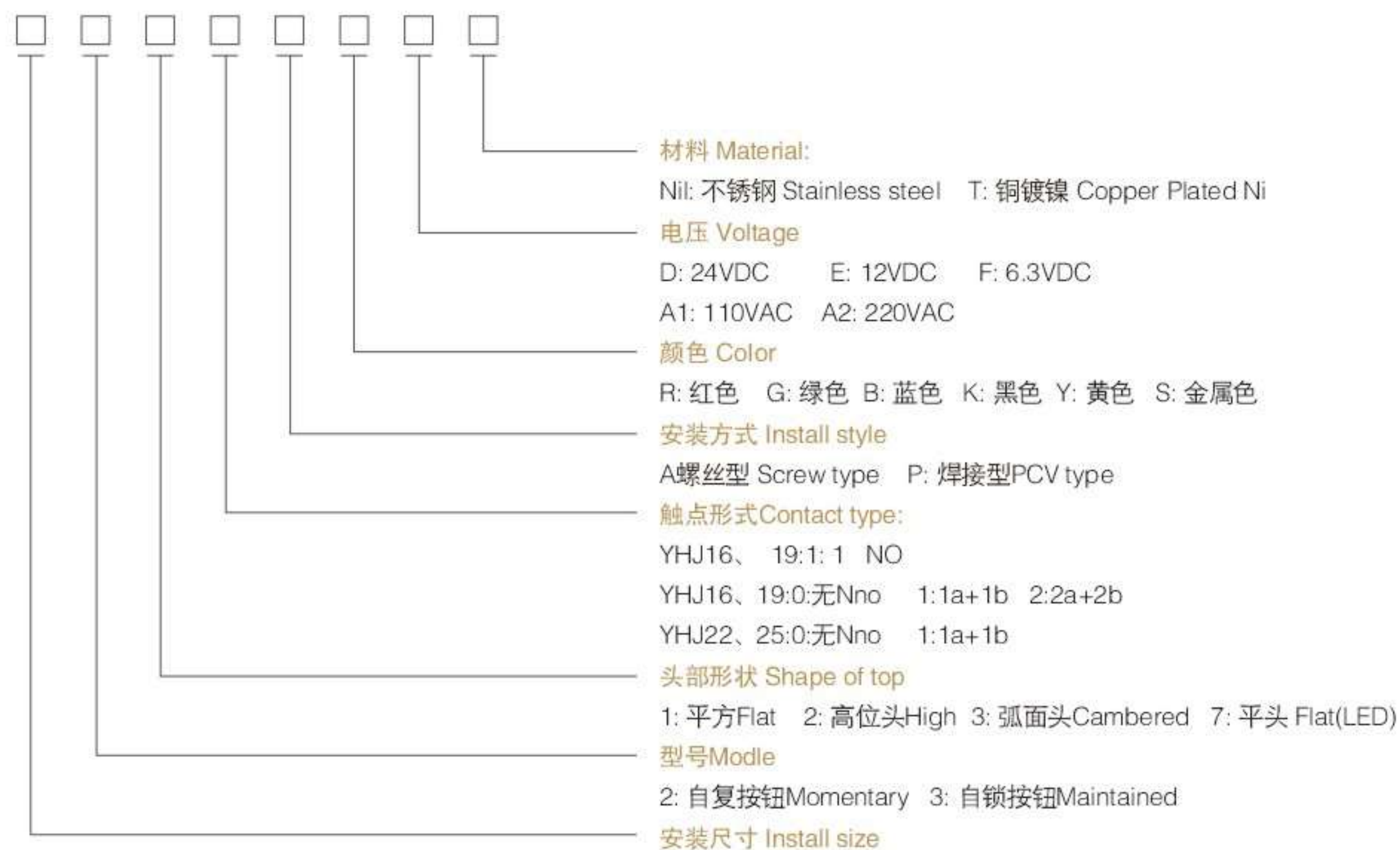









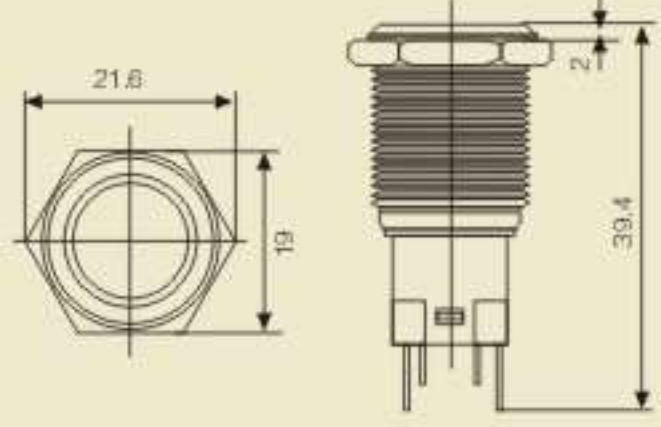

技术参数 Technical parameters

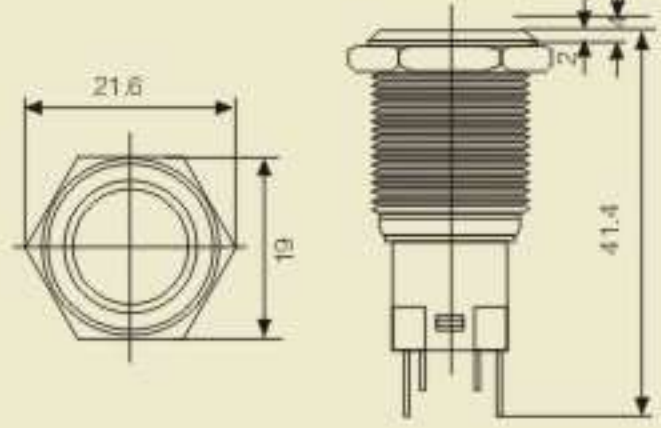
型号 Type	YHJ22、25	YHJ16、19	YHJ16、19
热流 Thermal current	5A	2A	3A
触点类型 Contact type	B: 1NO+1NC/2NO+2NC	1No	C: 1NO B: 1NO+1NC/2NO+2NC
触点材料 Contact material	Silver plated gold	Silver plated	Silver plated gold
保护等级 Degree of protection	IP67		
最大电压 Maximum voltage	250VAC/DC		
最小负载 Minimum applicable load	5VAC/DC 1mA		
端子形式 Terminal style	110° solder/Quick connect		
运行温度 Operating temperature	-25°C+55°C		
操作湿度 Operating humidity	45-85%RH		
接触电阻 Contact resistance	50MQ max		
绝缘电阻 Insulation resistance	100MΩ min(500VDC megger)		
震荡电阻 Vibration resistance	10to 55Hz amplitude 1.2mm P-P		
保护等级 Degree of protection	>10g		
电气寿命 Electrical life	100,000 operations minimum (at full rated load)		
机械寿命 Mechanical Life	Maintained: 1000,000 operations minimum		
	Momentary: 1,000,000 operations minimum		
	Selectlor / Keylock: 250,000 operations minimum		
耐压 Dielectrical life	Switch unit: 2,000VAC, 1min between live/dead part and terminals of different poles		
	1,000VAC, 1 minute between terminals of the same pole;		
	1,500VAC, 1 minute between contact and lamp terminals		
锡焊温度 Soldering temperature	Illumination unit: 2,000VAC, 1min between live part/ground		
	20W/5 seconds or 260°C/3 seconds		

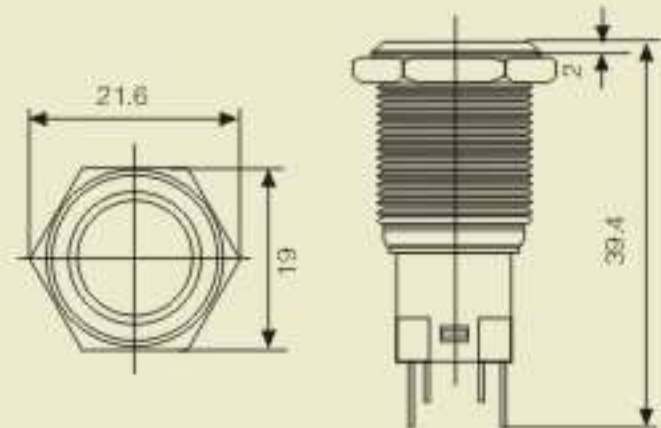

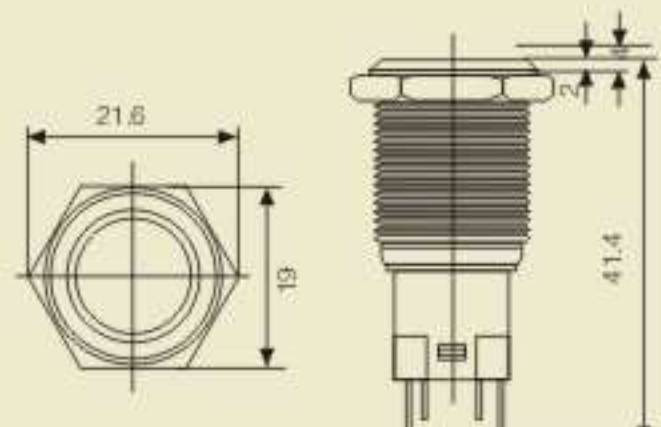

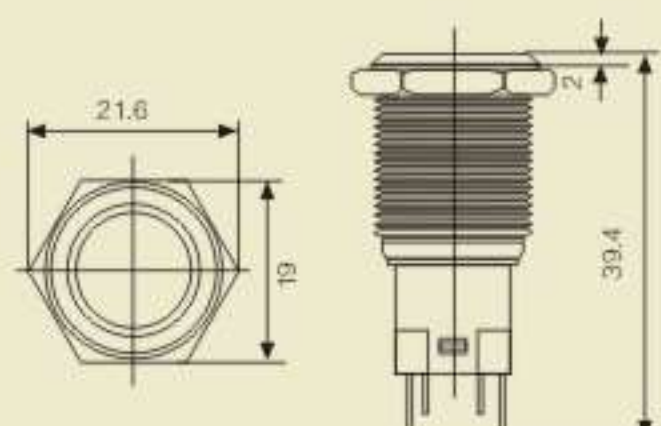

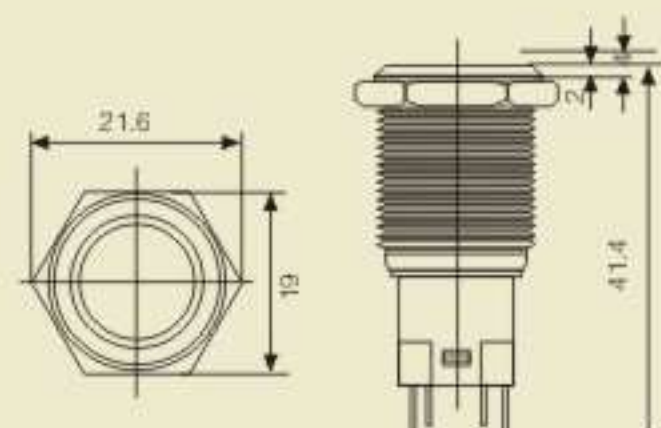

YHJ 金属按钮系列 YHJ Metal switch series

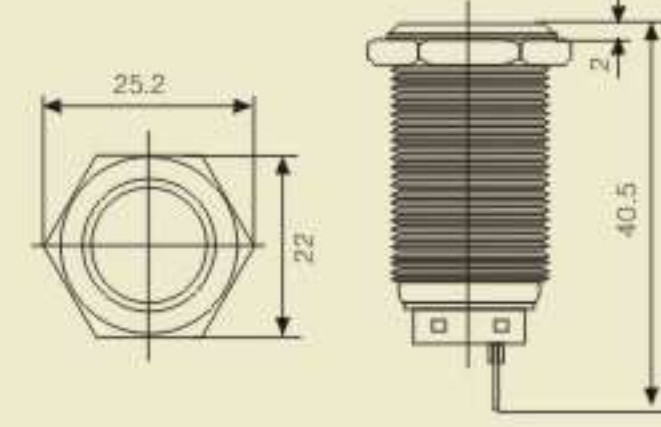
按钮 Push buttons	外形尺寸 Dimensions	按钮 Push buttons	外形尺寸 Dimensions
	平头螺丝型 Flat screw type 		平头焊线型 Flat PCB type 
YHJ16-211A		YHJ16-211P	
	高位螺丝型 High screw type 		高位焊线型 High PCB type 
YHJ16-221A		YHJ16-221P	
	弧面螺丝型 Cambered screw type 		弧面焊线型 Cambered PCB type 
YHJ16-231A		YHJ16-231P	
	平头螺丝型 Flat screw type 		平头焊线型 Flat PCB type 
YHJ19-211A		YHJ19-211P	
	高位螺丝型 High screw type 		高位焊线型 High PCB type 
YHJ19-221A		YHJ19-221P	
	弧面螺丝型 Cambered screw type 		弧面焊线型 Cambered PCB type 
YHJ19-231A		YHJ19-231P	

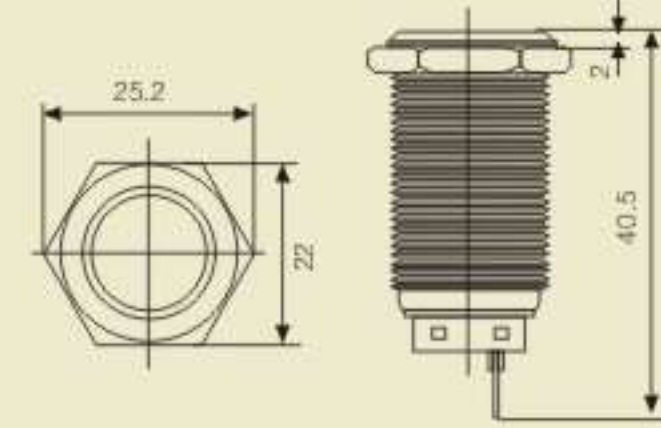
YHJ 金属按钮系列
YHJ Metal switch series

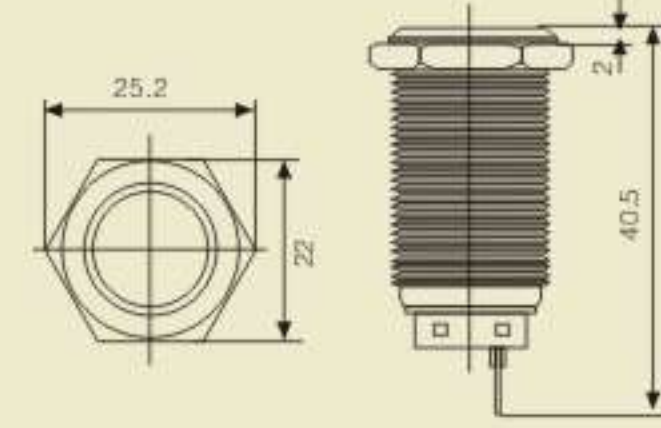
按钮 Push button	说明 Description	触点 Contact	颜色 Color	型号 Type	外形尺寸 Dimensions
	平头自复按钮 Flat momentary	1 Pole 2 Pole		YHJ16-211 YHJ16-212	
	平头自锁按钮 Flat maintained	1 Pole 2 Pole		YHJ16-311 YHJ16-312	
	高头自复按钮 High momentary	1 Pole 2 Pole		YHJ16-221 YHJ16-222	
	高头自锁按钮 High maintained	1 Pole 2 Pole		YHJ16-321 YHJ16-322	
	平头自复按钮 Flat momentary	1 Pole 24VDC 2 Pole 12VDC 6.3VDC	● Red ● Green ● Yellow	YHJ16-261 YHJ16-262	
	平头自锁按钮 Flat maintained	1 Pole 110VAC 2 Pole 220VAC	● Blue ● Black	YHJ16-361 YHJ16-362	
	高头自复按钮 High momentary	1 Pole 24VDC 2 Pole 12VDC 6.3VDC	● Red ● Green ● Yellow	YHJ16-271 YHJ16-272	
	高头自锁按钮 High maintained	1 Pole 110VAC 2 Pole 220VAC	● Blue ● Black	YHJ16-371 YHJ16-372	
	点面头自复按钮 Point momentary	1 Pole 24VDC 2 Pole 12VDC 6.3VDC	● Red ● Green ● Yellow	YHJ16-281 YHJ16-282	
	点面头自锁按钮 Point maintained	1 Pole 110VAC 2 Pole 220VAC	● Blue ● Black	YHJ16-381 YHJ16-382	
	高位点面头 自复按钮 High Point momentary	1 Pole 24VDC 2 Pole 12VDC 6.3VDC	● Red ● Green ● Yellow	YHJ16-281 YHJ16-282	
	高位点面头 自锁按钮 High Point maintained	1 Pole 110VAC 2 Pole 220VAC	● Blue ● Black	YHJ16-381 YHJ16-382	

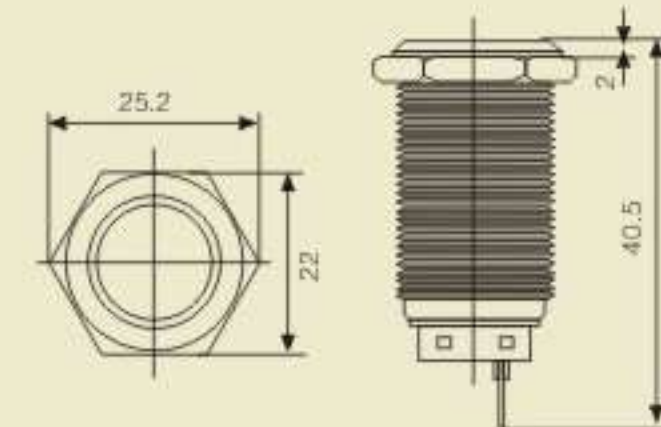
YHJ 金属按钮系列
YHJ Metal switch series

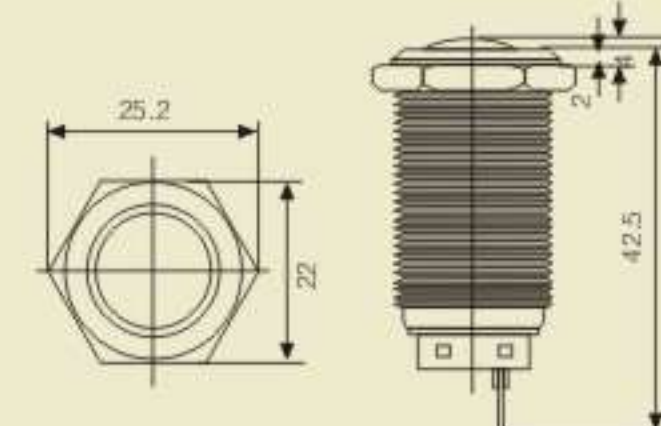
按钮 Push button	说明 Description	触点 Contact	颜色 Color	型号 Type	外形尺寸 Dimensions
	平头自复按钮 Flat momentary	1 Pole 2 Pole		YHJ19-211 YHJ19-212	
	平头自锁按钮 Flat maintained	1 Pole 2 Pole		YHJ19-311 YHJ19-312	
	平头自复按钮 Flat momentary	1 Pole 2 Pole		YHJ19-231 YHJ19-232	
	平头自锁按钮 Flat maintained	1 Pole 2 Pole		YHJ19-331 YHJ19-332	
	平头自复按钮 Flat momentary	1 Pole 24VDC 2 Pole 12VDC 6.3VDC	● Red ● Green ● Yellow	YHJ19-271 YHJ19-272	
	平头自锁按钮 Flat maintained	1 Pole 110VAC 2 Pole 220VAC	● Blue ● Black	YHJ19-371 YHJ19-372	
	点面头自复按钮 Point momentary	1 Pole 24VDC 2 Pole 12VDC 6.3VDC	● Red ● Green ● Yellow	YHJ19-281 YHJ19-282	
	点面头自锁按钮 Point maintained	1 Pole 110VAC 2 Pole 220VAC	● Blue ● Black	YHJ19-381 YHJ19-382	
	弧面头自复按钮 Cammered momentary	1 Pole 24VDC 2 Pole 12VDC 6.3VDC	● Red ● Green ● Yellow	YHJ19-291 YHJ19-292	
	弧面头自锁按钮 Cammered Point maintained	1 Pole 110VAC 2 Pole 220VAC	● Blue ● Black	YHJ19-391 YHJ19-392	

YHJ16安装尺寸 Install size

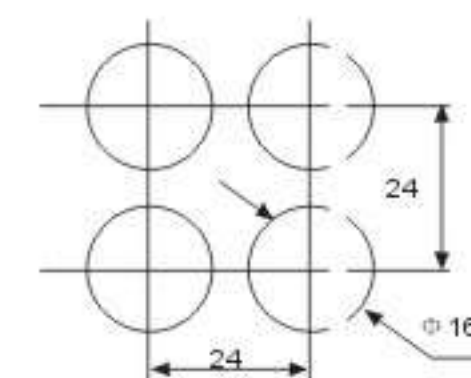



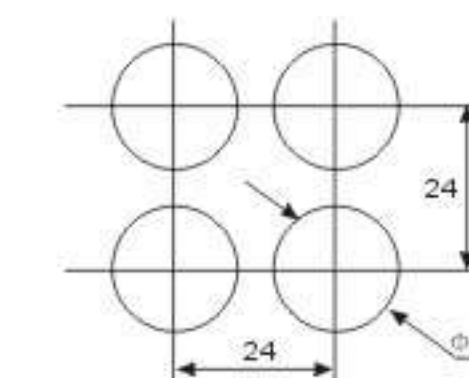

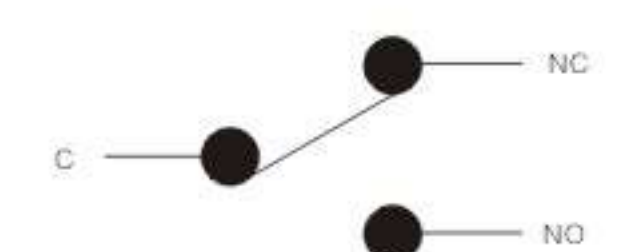

YHJ19安装尺寸 Install size

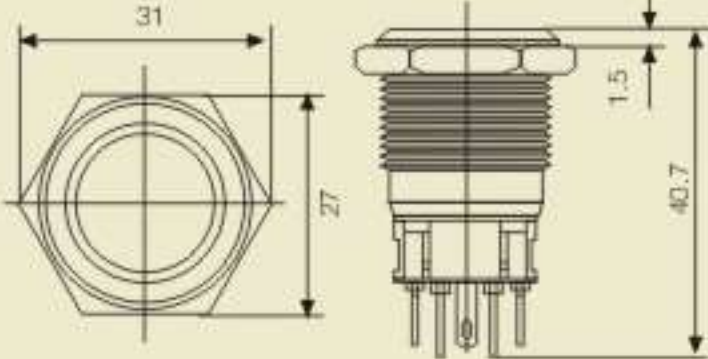

触点方式 Contact style

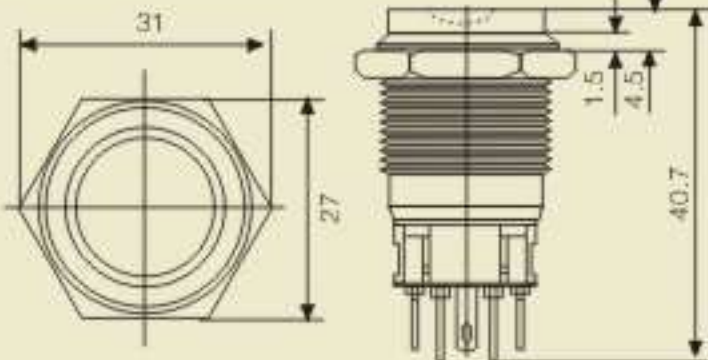

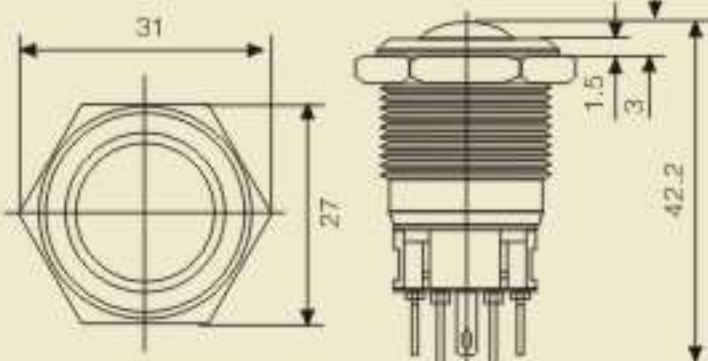
YHJ 金属按钮系列 YHJ Metal switch series

按钮 Push button	说明 Description	触点 Contact	颜色 Color	型号 Type	外形尺寸 Dimensions
	平头自复按钮 Flat momentary	1 Pole		YHJ22-211	
	平头自锁按钮 Flat maintained	1 Pole		YHJ22-311	
	高位头自复按钮 High momentary	1 Pole		YHJ22-221	
	高位头自锁按钮 High maintained	1 Pole		YHJ22-321	
	弧面头自复按钮 Camnered momentary	1 Pole		YHJ22-231	
	弧面头自锁按钮 Camnered Point maintained	1 Pole		YHJ22-331	
	平头自复按钮 Flat momentary	1 Pole	24VDC 12VDC 6.3VDC 110VAC	YHJ22-271	
	平头自锁按钮 Flat maintained	1 Pole	220VAC	YHJ22-371	
	点面头自复按钮 Point momentary	1 Pole	24VDC 12VDC 6.3VDC 110VAC	YHJ22-281	
	点面头自锁按钮 Point maintained	1 Pole	220VAC	YHJ22-381	

YHJ22安装尺寸 Install size

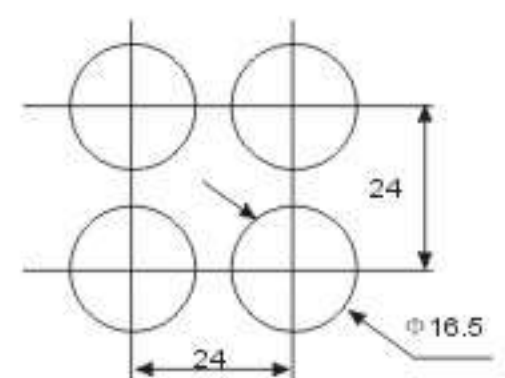



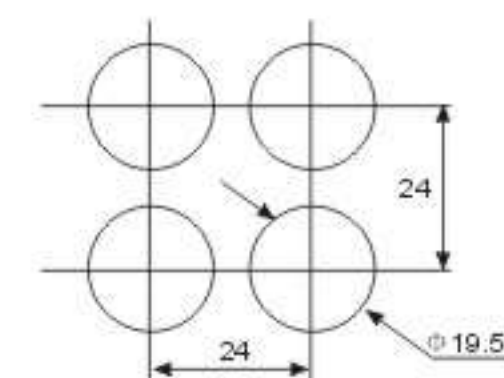



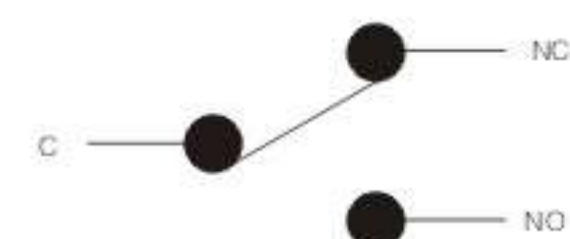

YHJ25安装尺寸 Install size

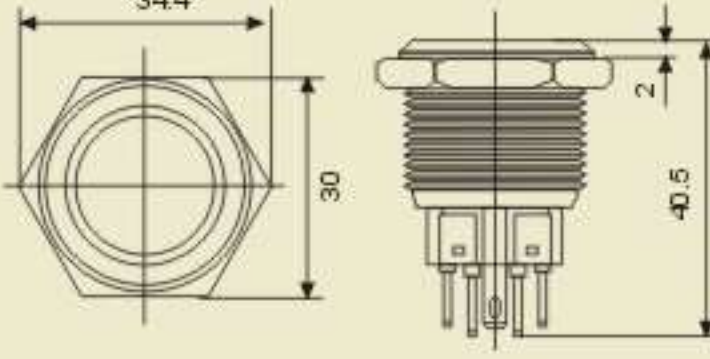

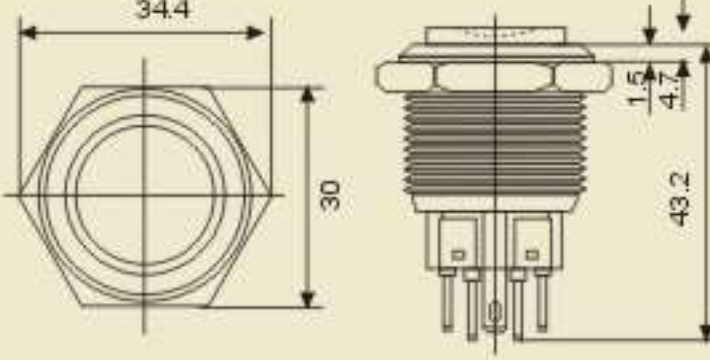
触点方式 Contact style

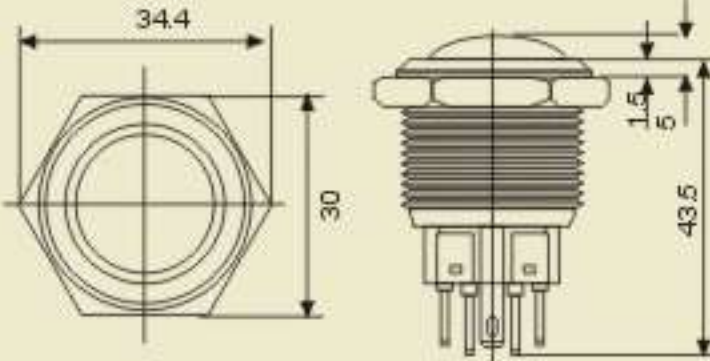

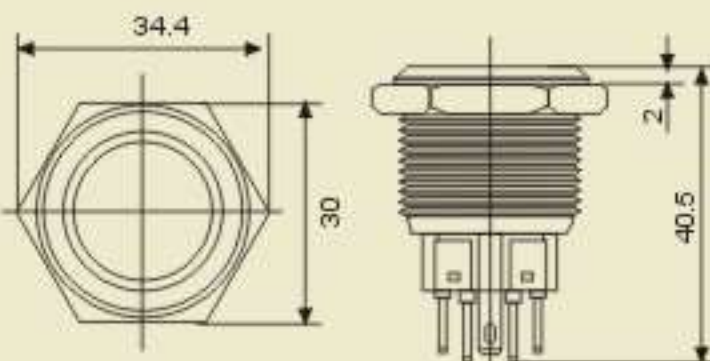
YHJ 金属按钮系列 YHJ Metal switch series

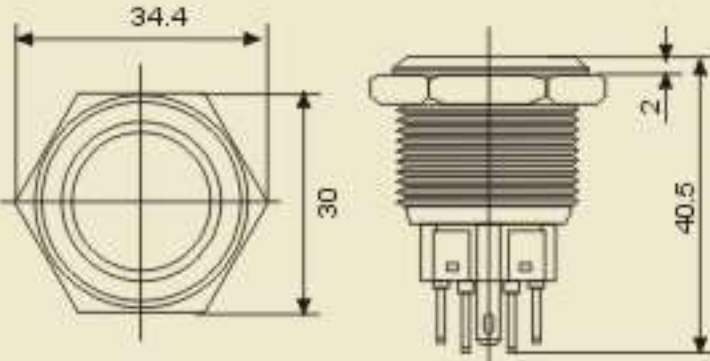
按钮 Push button	说明 Description	触点 Contact	颜色 Color	型号 Type	外形尺寸 Dimensions
	平头自复按钮 Flat momentary	1 Pole 2 Pole		YHJ25-211 YHJ25-212	
	平头自锁按钮 Flat maintained	1 Pole 2 Pole		YHJ25-311 YHJ25-312	
	高位头自复按钮 High momentary	1 Pole 2 Pole		YHJ25-221 YHJ25-222	
	高位头自锁按钮 High maintained	1 Pole 2 Pole		YHJ25-321 YHJ25-322	
	弧面头自复按钮 Camnered momentary	1 Pole 2 Pole		YHJ25-231 YHJ25-232	
	弧面头自锁按钮 Camnered Point maintained	1 Pole 2 Pole		YHJ25-331 YHJ25-332	
	平头自复按钮 Flat momentary	1 Pole 2 Pole	24VDC 12VDC 6.3VDC 110VAC	YHJ25-271 YHJ25-371	
	平头自锁按钮 Flat maintained	1 Pole 2 Pole	220VAC	YHJ25-371 YHJ25-382	
	点面头自复按钮 Point momentary	1 Pole 2 Pole	24VDC 12VDC 6.3VDC 110VAC	YHJ25-281 YHJ25-381	
	点面头自锁按钮 Point maintained	1 Pole 2 Pole	220VAC	YHJ25-381 YHJ25-381	

工作电压 Working voltage	阻性	24V	110V	220V
接触参数 Contact parameter	感性	-	1.0A	0.5A
	阻性	-	0.7A	0.5A
	感性	1.0A	0.2A	-
		0.7A	0.1A	-

LAY90-V16 系列按钮 LAY90-V16 Push button series

□适用范围

LAY90-V16 系列按钮功能齐全，能充分满足国内外程控装置、电子电器控制的需要，广泛应用于交流50Hz/60Hz，电压AC/DC220V的机床、纺织、船舶、航空、汽车、烟草、电力、电讯、医疗器械等各领域做控制电路、信号、联锁等配套使用。

□结构特点

LAY90-V16 系列按钮由组成头部操作机构的螺纹套部件和组成触头动作机构的底座部件二大系统组成。所有结构件的联接均采用国际先进的紧固件卡扣自锁联接的结构形式，装拆方便、安全可靠。并采用防转动结构，使按钮安装定位正确，防止松动。

□触点

底座部件具有一个常开和一个常闭或二个常开和二个常闭触头，设计有触点自洁机构，属单断瞬时型开关，触头连同接触片整体镀金是接触可靠、电性能稳定的确切保证。

□型号含义 Models and meaning

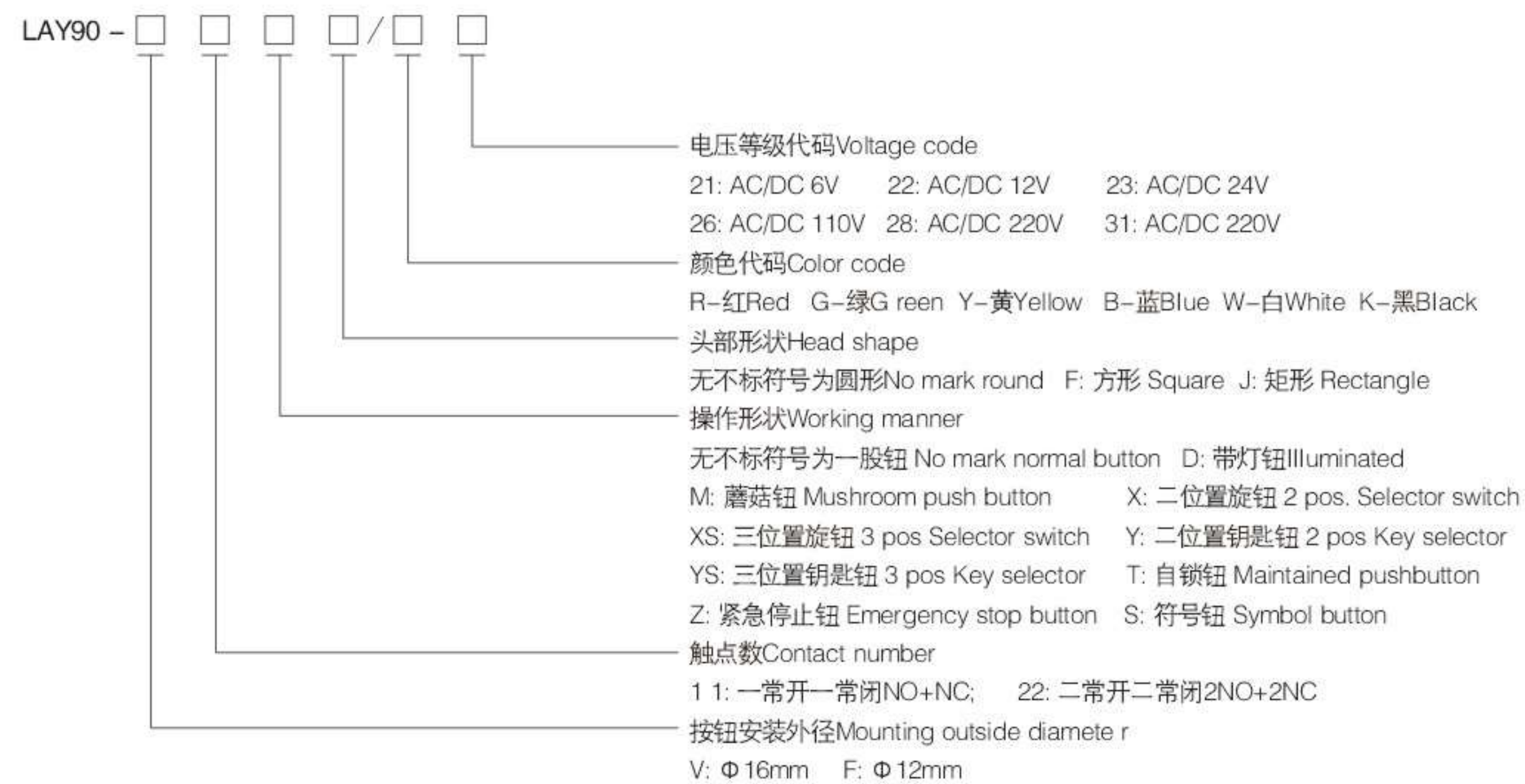

□Application range

LAY90-V16 series pushbutton can be used in many fields with its complete functions. They can sufficiently meet the need of digital programmed control system and electric control machine all the world. They are widely applied to textile machine, aerospace, automobile, tobacco machine, electric power, telecommunication and medical instruments which their power supply is 220V AC 50Hz Or 60Hz 220V DC, acting as part of circuit control, signal control and interlock in the machine.

□Constructional feature

LAY90-V16 series pushbuttons consist of two main systems; one is screw-set unit which forms the operating device, another is the basic unit, which acts as the contact device. All the constructional connections adopt the advanced international technologies that are integrated snap-fastening and self-locking modes without any clamping units, so it highly dependable and easy to assemble and disassemble. The anti-rotating structure ensures the accurate mounting position of pushbuttons and prevents them from becoming loose.

□Contact

The basic unit of the pushbutton has 1 NO and 1 NC or 2NO and 2 NC contacts with a self-cleaning system It belongs to single break momentary switches. Both the contact head and the contact piece are gold-planted to ensure a reliable contact and stable electrical performance.

□技术参数 Technical parameter

工作温度Operational temperature	-25°C~+55°C		
工作湿度Operational humidity	45~85%RH		
接触电阻Contact resistance	≤50MΩ		
绝缘电阻Insulation resistance	≥100MΩ		
工频耐压Power-frequency withstand voltage	2000VAC		
电气寿命Electrical life	AC-15	10万次(300次/小时) 0.1 mil operations 300 time/per hour	
	DC-13	5万次(300次/小时) 50 thousand operations time/per hour	
防护等级Protection level	IP40		
动作行程Operational travel	1.5~2.0mm		
额定绝缘电压Ui Rated insulation voltage Ui	250V		
约定发热电流Ith Conventional thermal current Ith	5A		
额定工作电压Ue Rated operational voltage Ue	220V	24V	110V
	0.5A	2A	1A
	0.1A	0.7A	0.2A

□安装开孔尺寸 Size of mounting hole

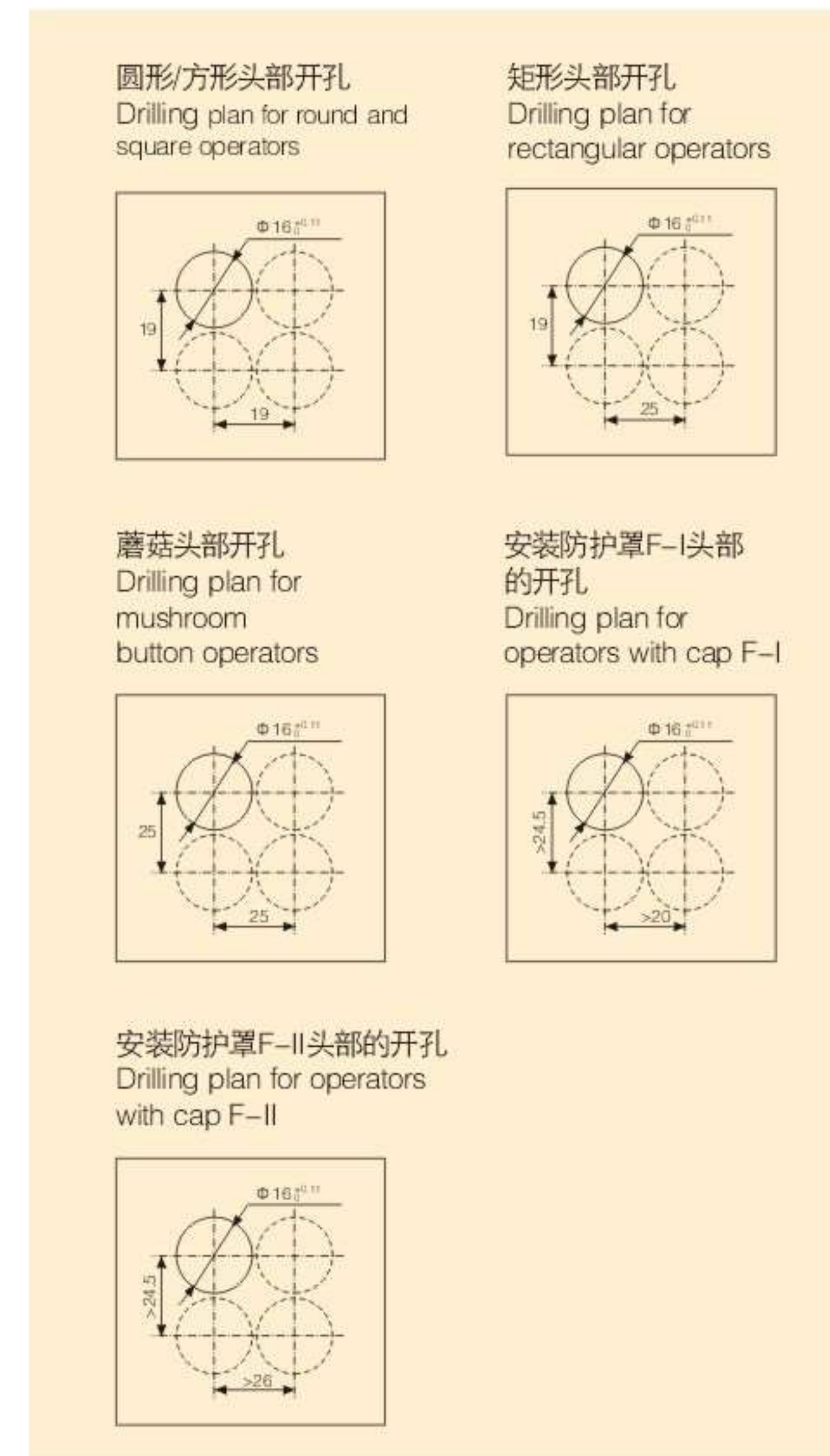

□触点形式及接线示意图 Contact model and wiring diagram

一常开一常闭
One normally open and one normally close, wiring diagram

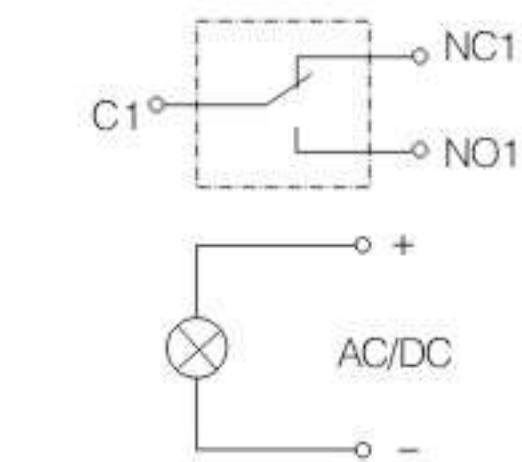

接线示意图
Light connecting terminals

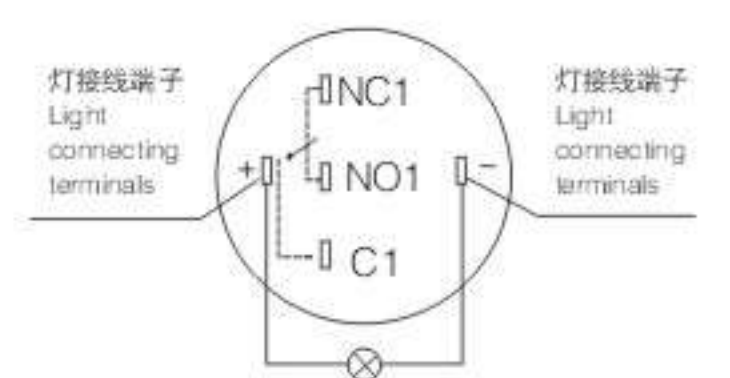

二常开二常闭
Two normally open and two normally close, wiring diagram

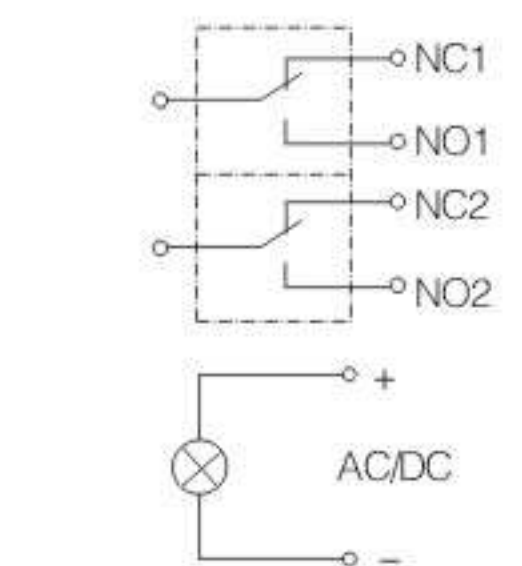



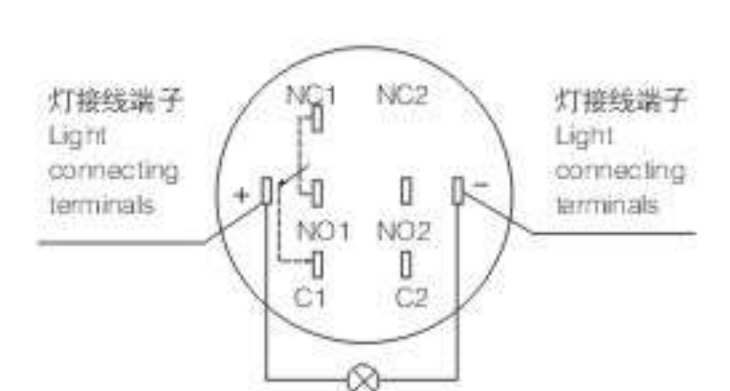





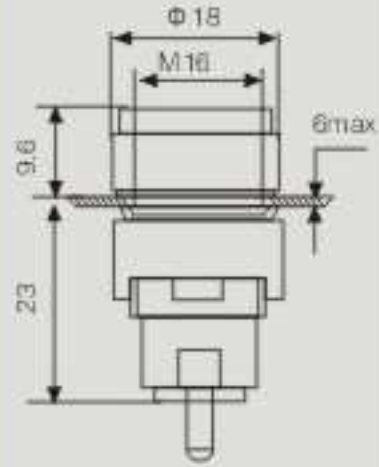

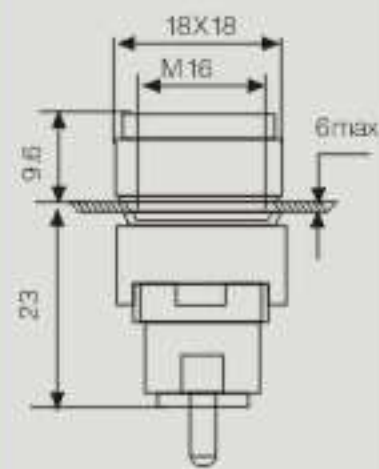
接线示意图
Light connecting terminals

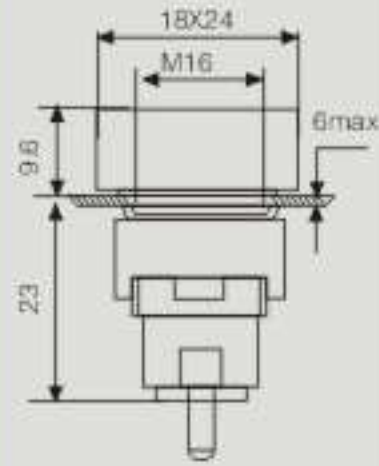

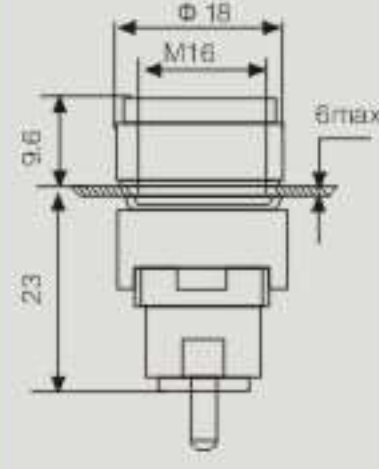

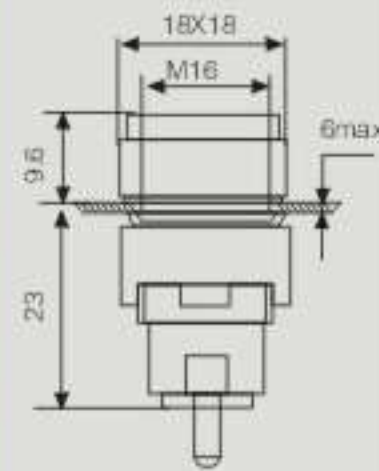

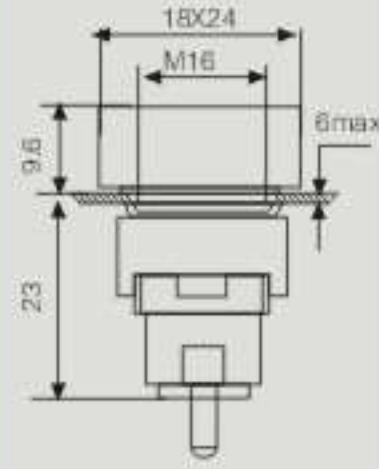

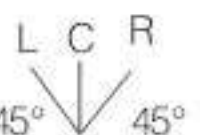
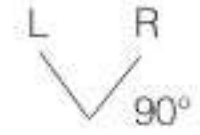

LAY90-V16 系列按钮

LAY90-V16 Push button series

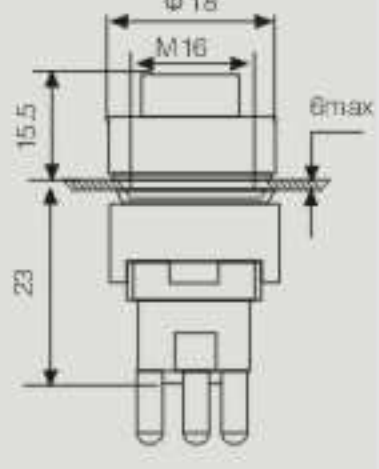
按钮 Push button	说明 Description	工作状态 Seitching action	灯电压 Lamp voltage	颜色 Color	型号 Type	外形尺寸 Dimensons
	圆钮 Round push button	瞬动 Momentary		<ul style="list-style-type: none"> ● Red ● Green/PG ● Yellow ● Pure Blue ○ White/PW 	LAY90-V11/□□ LAY90-V22/□□	
		自锁 Maintained			LAY90-V11T/□□ LAY90-V22T/□□	
	方钮 Square push button	瞬动 Momentary		<ul style="list-style-type: none"> ● Red ● Green/PG ● Yellow ● Pure Blue ○ White/PW 	LAY90-V11F/□□ LAY90-V22F/□□	
		自锁 Maintained			LAY90-V11TF/□□ LAY90-V22TF/□□	
	矩钮 Rectangle push button	瞬动 Momentary		<ul style="list-style-type: none"> ● Red ● Green/PG ● Yellow ● Pure Blue ○ White/PW 	LAY90-V11J/□□ LAY90-V22J/□□	
		自锁 Maintained			LAY90-V11TJ/□□ LAY90-V22TJ/□□	
	带灯圆钮 Illuminated Round push button	瞬动 Momentary	AC/DC 6V 12V 24V 48V	<ul style="list-style-type: none"> ● Red ● Green/PG ● Yellow ● Pure Blue ○ White/PW 	LAY90-V11D/□□ LAY90-V22D/□□	
		自锁 Maintained			LAY90-V11TD/□□ LAY90-V22TD/□□	
	带灯方钮 Illuminated Square push button	瞬动 Momentary	AC/DC 6V 12V 24V 48V 127V 220V	<ul style="list-style-type: none"> ● Red ● Green/PG ● Yellow ● Pure Blue ○ White/PW 	LAY90-V11DF/□□ LAY90-V22DF/□□	
		自锁 Maintained			LAY90-V11TDF/□□ LAY90-V22TDF/□□	
	带灯矩钮 Illuminated Rectangle push button	瞬动 Momentary	AC/DC 6V 12V 24V 48V 127V 220V	<ul style="list-style-type: none"> ● Red ● Green/PG ● Yellow ● Pure Blue ○ White/PW 	LAY90-V11DJ/□□ LAY90-V22DJ/□□	
		自锁 Maintained			LAY90-V11TDJ/□□ LAY90-V22TDJ/□□	

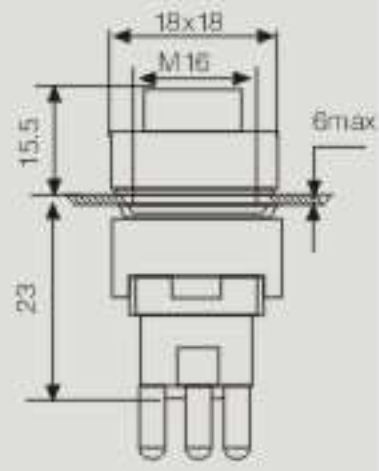
LAY90-V16 系列按钮

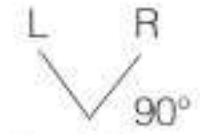
LAY90-V16 Push button series

按钮 Push button	说明 Description	工作状态 Seitching action	灯电压 Lamp voltage	颜色 Color	型号 Type	外形尺寸 Dimensons
	圆形旋钮 Round Turn button	 二位置保持 2-pos.maintained		● Black	LAY90-V11X/□□ LAY90-V22X/□□	
		 三位置保持 3-pos.maintained			LAY90-V22XS/□□	
	方形旋钮 Square Turn button	 二位置保持 2-pos.maintained		● Black	LAY90-V11XF/□□ LAY90-V22XF/□□	
		 三位置保持 3-pos.maintained			LAY90-V22XSF/□□	
	矩形旋钮 Rectangle Turn button	 二位置保持 2-pos.maintained		● Black	LAY90-V11XJ/□□ LAY90-V22XJ/□□	
		 三位置保持 3-pos.maintained			LAY90-V22XSJ/□□	
	圆形带灯旋钮 Round illuminated Turn button	 二位置保持 2-pos.maintained	AC/DC 6V 24V 110V	<ul style="list-style-type: none"> ● Red ● Green/PG ● Yellow ● Pure Blue ○ White/PW 	LAY90-V11XD/□□ LAY90-V22XD/□□	
		 三位置保持 3-pos.maintained			DC 220V AC 220V	
	方形带灯旋钮 Square illuminated Turn button	 二位置保持 2-pos.maintained	AC/DC 6V 24V 110V	<ul style="list-style-type: none"> ● Red ● Green/PG ● Yellow ● Pure Blue ○ White/PW 	LAY90-V11XDF/□□ LAY90-V22XDF/□□	
		 三位置保持 3-pos.maintained			DC 220V AC 220V	
	矩形带灯旋钮 Rectangle illuminated Turn button	 二位置保持 2-pos.maintained	AC/DC 6V 24V 110V	<ul style="list-style-type: none"> ● Red ● Green/PG ● Yellow ● Pure Blue ○ White/PW 	LAY90-V11XDJ/□□ LAY90-V22XDJ/□□	
		 三位置保持 3-pos.maintained			DC 220V AC 220V	





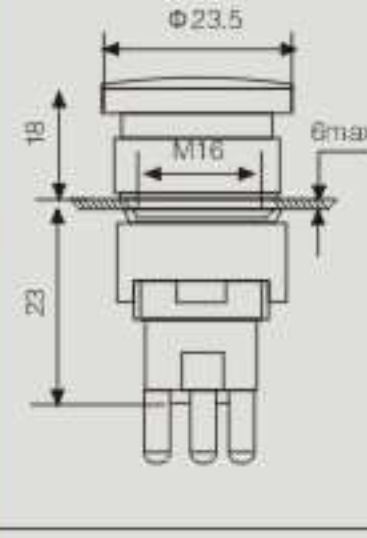



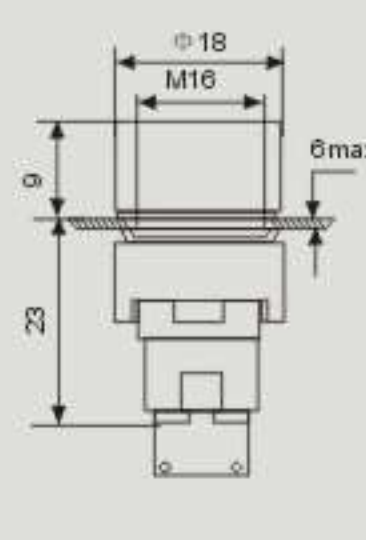

LAY90-V16 系列按钮

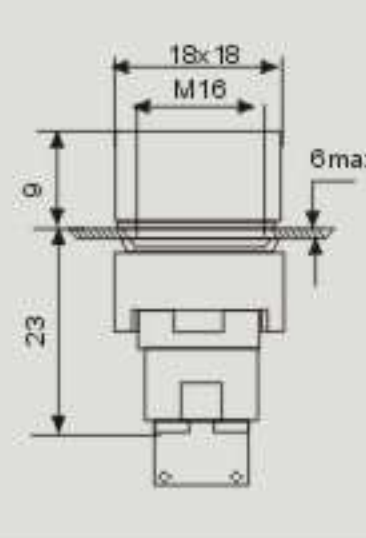
LAY90-V16 Push button series

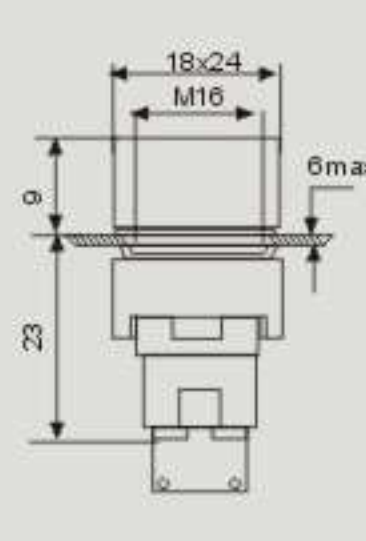
按钮 Push button	说明 Description	工作状态 Seitching action	灯电压 Lamp voltage	颜色 Color	型号 Type	外形尺寸 Dimensions
	圆形钥匙钮 Round Key selectors	二位置保持 2-pos.maintained 三位置保持 3-pos.maintained		● Black	LAY90-V11Y/□□ LAY90-V22Y/□□ LAY90-V22YS/□□	
	方形钥匙钮 Square Key selectors	二位置保持 2-pos.maintained 三位置保持 3-pos.maintained		● Black	LAY90-V11YF/□□ LAY90-V22YF/□□ LAY90-V22XSF/□□	
	矩形钥匙钮 Rectangle Key selectors	二位置保持 2-pos.maintained 三位置保持 3-pos.maintained		● Black	LAY90-V11YJ/□□ LAY90-V22YJ/□□ LAY90-V22YSJ/□□	
	紧急钮 Emergency stop pushbutton	按下锁定 右旋复位 Push to maintained turn right to release	AC/DC 6V 12V 24V 110V DC 220V AC 220V	● Red	LAY90-V11Z/□□ LAY90-V22Z/□□	
	蘑菇钮 Mushroom pushbutton	瞬动 Momentary 自锁 Maintained	AC/DC 6V 12V 24V 110V DC 220V AC 220V	● Red ● Green/PG ● Yellow ● Pure Blue ○ White/PW	LAY90-V11M/□□ LAY90-V22M/□□ LAY90-V11MT/□□ LAY90-V22MT/□□	
	带灯蘑菇钮 Illuminated Mushroom pushbutton	瞬动 Momentary 自锁 Maintained	AC/DC 6V 12V 24V 110V DC 220V AC 220V	● Red ● Green/PG ● Yellow ● Pure Blue ○ White/PW	LAY90-V11MD/□□ LAY90-V22MD/□□ LAY90-V11MTD/□□ LAY90-V22MTD/□□	

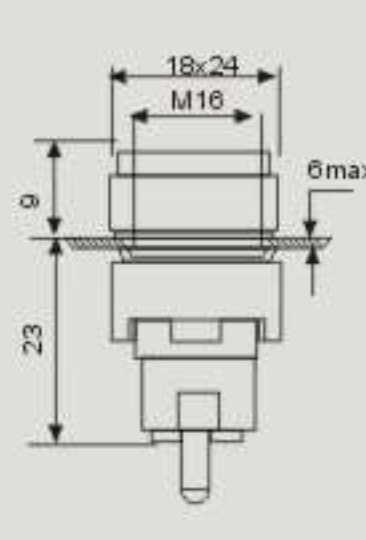

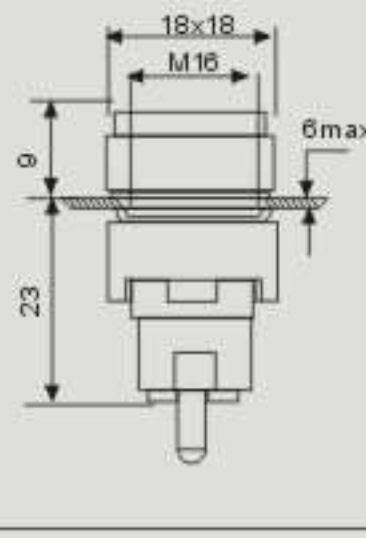

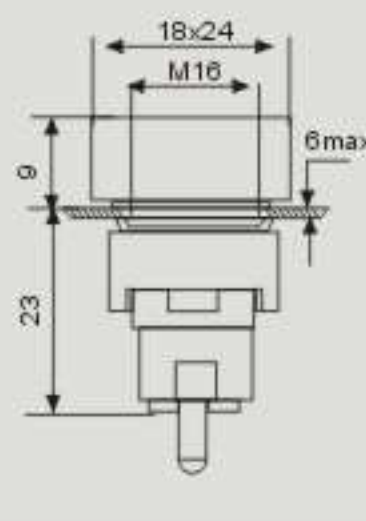



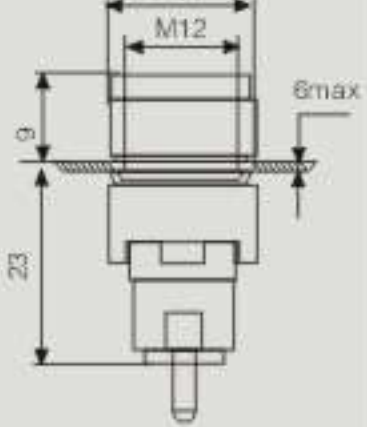

LAY90-V16 系列按钮

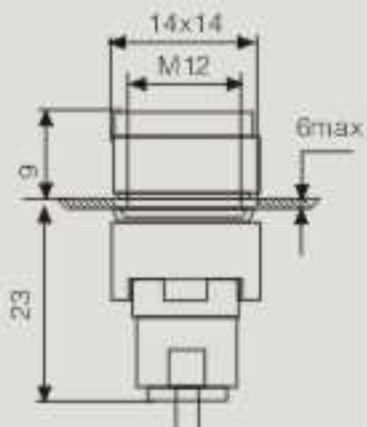
LAY90-V16 Push button series

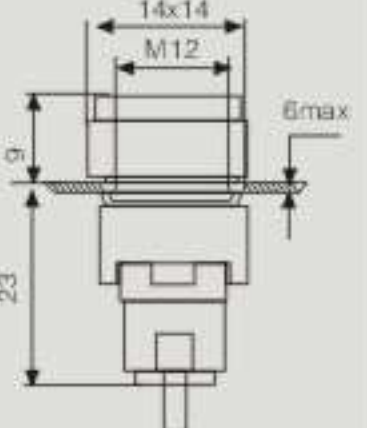
按钮 Push button	说明 Description	工作状态 Seitching action	灯电压 Lamp voltage	颜色 Color	型号 Type	外形尺寸 Dimensions
	圆形蜂鸣器 Round indicator buzzer	A 间断 interrupted B 长鸣 constant	75dB在10cm处 额定电压下 2300Hz ± 400Hz 75db at the distance of 10cm and rated voltage supplied	AD/DC 6V 12V 24V 36V 48V	● Black	LAY90-AF
						
	方形蜂鸣器 Square indicator buzzer	A 间断 interrupted B 长鸣 constant	75dB在10cm处 额定电压下 2300Hz ± 400Hz 75db at the distance of 10cm and rated voltage supplied	AC/DC 6V 12V 24V 36V 48V	● Black	LAY90-FF
						
	矩形蜂鸣器 Rectangle indicator buzzer	A 间断 interrupted B 长鸣 constant	75dB在10cm处 额定电压下 2300Hz ± 400Hz 75db at the distance of 10cm and rated voltage supplied	AC/DC 6V 12V 24V 36V 48V	● Black	LAY90-JF
						
	圆形指示灯 Round pilot light		AC/DC 6V 12V 24V 48V 110V DC 220V AC 220V	● Red ● Green/PG ● Yellow ● Pure Blue ○ White/PW		LAY90-C/□□
						
	方形指示灯 Square pilot light		AC/DC 6V 12V 24V 48V 110V DC 220V AC 220V	● Red ● Green/PG ● Yellow ● Pure Blue ○ White/PW		LAY90-CF/□□
						
	矩形指示灯 Rectangle pilot light		AC/DC 6V 12V 24V 48V 110V DC 220V AC 220V	● Red ● Green/PG ● Yellow ● Pure Blue ○ White/PW		LAY90-CJ/□□
						

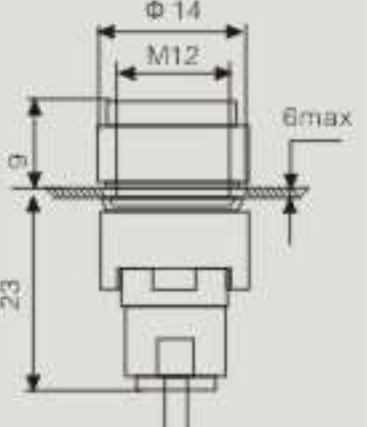

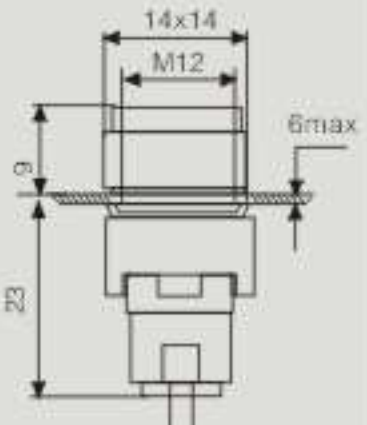

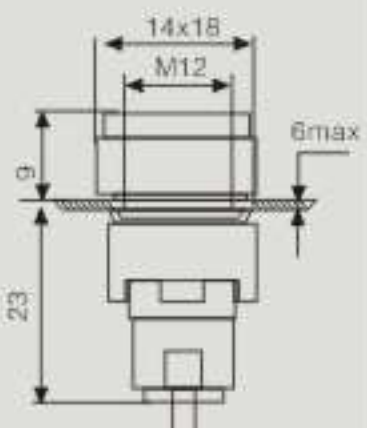





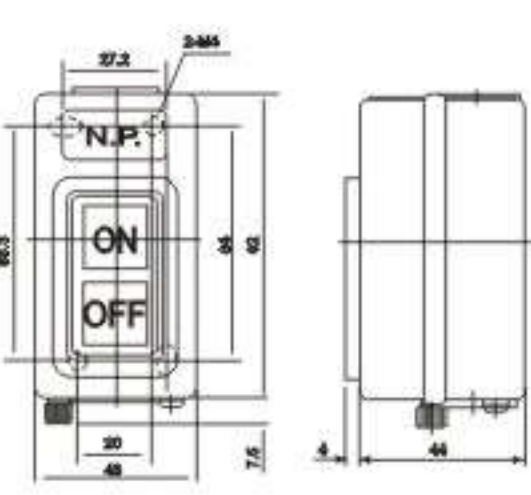

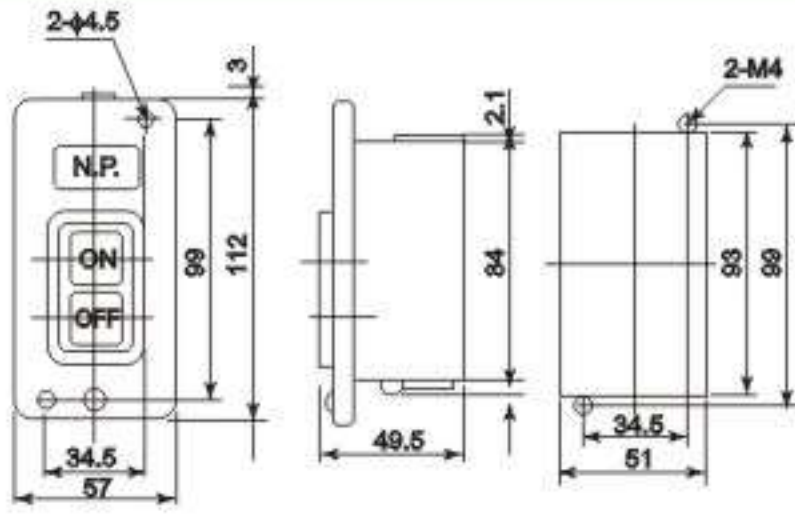

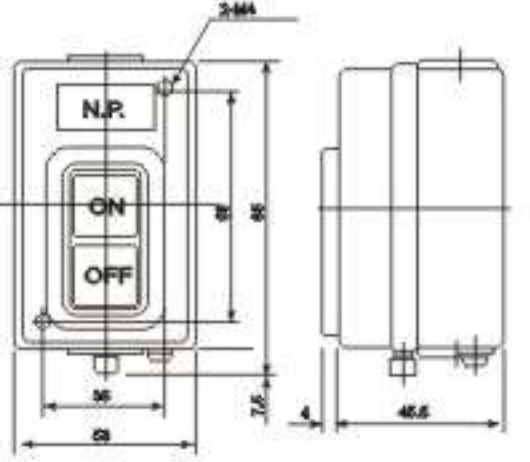

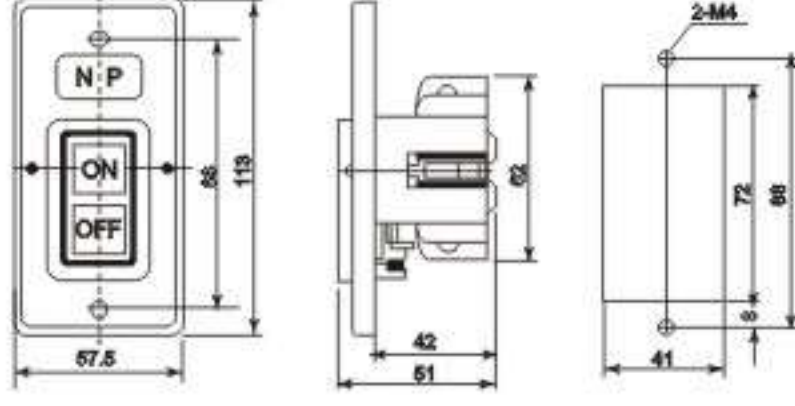

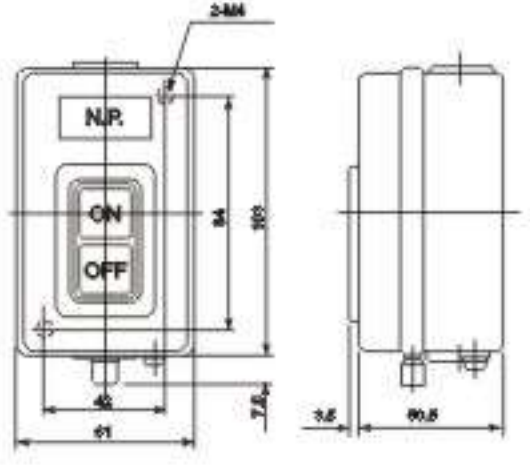
LAY90-V16 系列按钮

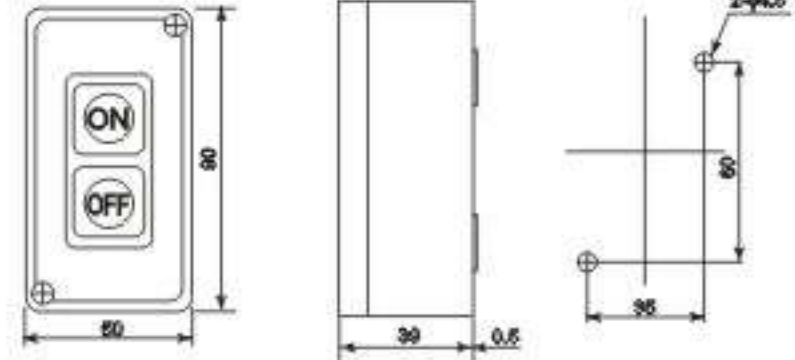
LAY90-V16 Push button series

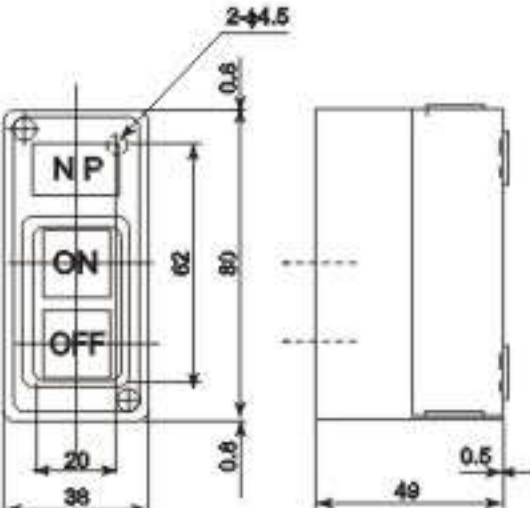
按钮 Push button	说明 Description	工作状态 Seitching action	灯电压 Lamp voltage	颜色 Color	型号 Type	外形尺寸 Dimensions
	圆钮 Round Pushbutton	瞬动 Momentary		● Red ● Green/PG ● Yellow ● Pure Blue ○ White/PW	LAY90-F11/□□ LAY90-F22/□□	
LAY90-F11		自锁 Maintained			LAY90-F11T/□□ LAY90-F22T/□□	
	方钮 Square push button	瞬动 Momentary		● Red ● Green/PG ● Yellow ● Pure Blue ○ White/PW	LAY90-F11F/□□ LAY90-F22F/□□	
LAY90-F11F		自锁 Maintained			LAY90-F11TF/□□ LAY90-F22TF/□□	
	矩钮 Rectangle push button	瞬动 Momentary		● Red ● Green/PG ● Yellow ● Pure Blue ○ White/PW	LAY90-F11J/□□ LAY90-F22J/□□	
LAY90-F11J		自锁 Maintained			LAY90-F11TJ/□□ LAY90-F22TJ/□□	
	带灯圆钮 Illuminated Round push button	瞬动 Momentary	AC/DC 6V 12V 24V 48V	● Red ● Green/PG ● Yellow ● Pure Blue ○ White/PW	LAY90-F11D/□□ LAY90-F22D/□□	
LAY90-F11D		自锁 Maintained	127V 220V		LAY90-F11TD/□□ LAY90-F22TD/□□	
	带灯方钮 Illuminated Square push button	瞬动 Momentary	AC/DC 6V 12V 24V 48V	● Red ● Green/PG ● Yellow ● Pure Blue ○ White/PW	LAY90-F11DF/□□ LAY90-F22DF/□□	
LAY90-F11DF		自锁 Maintained	127V 220V		LAY90-F11TDF/□□ LAY90-F22TDF/□□	
	带灯矩钮 Illuminated Rectangle push button	瞬动 Momentary	AC/DC 6V 12V 24V 48V	● Red ● Green/PG ● Yellow ● Pure Blue ○ White/PW	LAY90-F11DJ/□□ LAY90-F22DJ/□□	
LAY90-F11DJ		自锁 Maintained	127V 220V		LAY90-F11TDJ/□□ LAY90-F22TDJ/□□	

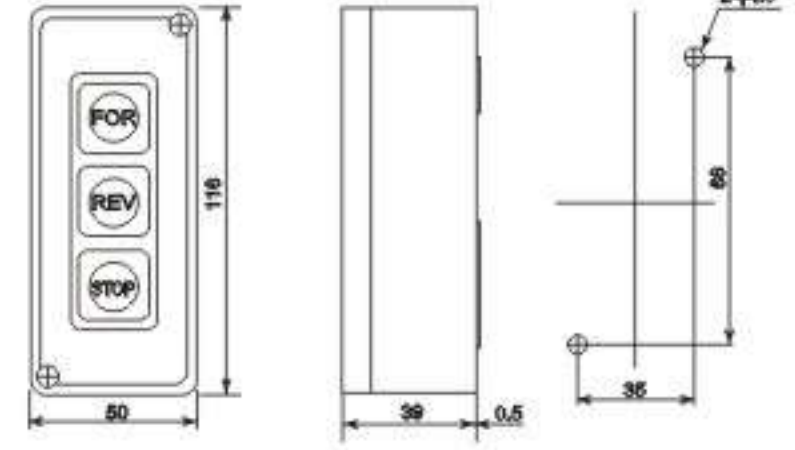
动力押扣开闭器系列

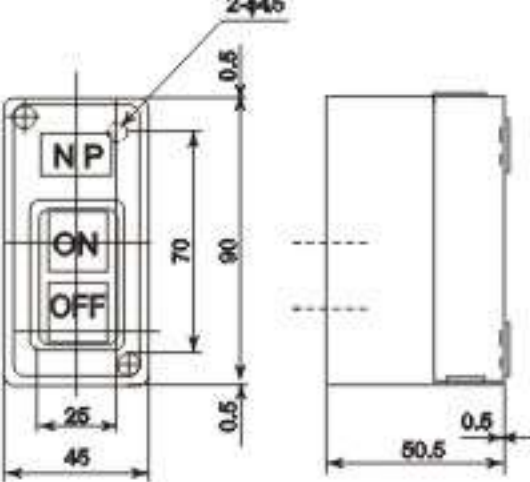
Power push button switch series

			
BS211B(TBSN)-310		TBSY-315,330	
			
BS216B(TBSN)-315		TBSS-315,330	
			
BS230(TBSN)-330		TPB-2	
			
TBSP-315		TPB-3	
			
TBSP-330		BS315	

特性

型式	规格	安装型式	接线端子	外壳材质
BS211B(TBSN)-310	3Φ10A 1.5KW	露出型	M3.5	铁烤漆
BS216B(TBSN)-315	3Φ15A 2.2KW	"	M4	"
BS230(TBSN)-330	3Φ30A 3.7KW	"	M5	"
TBSP-315	3Φ15A 2.2KW	露出型	M3.5	强化塑胶
TBSP-330	3Φ30A 3.7KW	"	M4	"
TBSY-315	3Φ15A 2.2KW	埋入型	M4	铁烤漆
TBSY-330	3Φ30A 3.7KW	"	M4	"
TBSS-315	3Φ15A 2.2KW	"	M4	"
TBSS-330	3Φ30A 3.7KW	"	M4	"

