

BAS316WS

Silicon Epitaxial Planar Switching Diode

Applications

- High-speed switching

PINNING

PIN	DESCRIPTION
1	Cathode
2	Anode

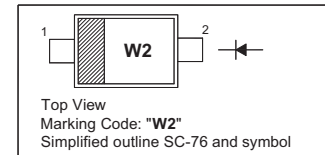

Absolute Maximum Ratings ($T_a = 25\text{ }^\circ\text{C}$)

Parameter	Symbol	Value	Unit
Repetitive Peak Reverse Voltage	V_{RRM}	100	V
Reverse Voltage	V_R	100	V
Continuous Forward Current	I_F	250	mA
Repetitive Peak Forward Current	I_{FRM}	500	mA
Non-Repetitive Peak Forward Current	I_{FSM}	4 1 0.5	A
		$t = 1\ \mu\text{s}$	
		$t = 1\ \text{ms}$	
		$t = 1\ \text{s}$	
Total Power Dissipation	P_{tot}	200	mW
Junction Temperature	T_j	150	$^\circ\text{C}$
Storage Temperature Range	T_{stg}	- 65 to + 150	$^\circ\text{C}$

Characteristics at $T_a = 25\text{ }^\circ\text{C}$

Parameter	Symbol	Max.	Unit
Forward Voltage at $I_F = 1\ \text{mA}$ at $I_F = 10\ \text{mA}$ at $I_F = 50\ \text{mA}$ at $I_F = 150\ \text{mA}$	V_F	0.715 0.855 1 1.25	V
Reverse Current at $V_R = 25\ \text{V}$ at $V_R = 75\ \text{V}$ at $V_R = 25\ \text{V}, T_j = 150\text{ }^\circ\text{C}$ at $V_R = 75\ \text{V}, T_j = 150\text{ }^\circ\text{C}$	I_R	30 1 30 50	nA μA μA μA
Diode Capacitance at $V_R = 0\ \text{V}, f = 1\ \text{MHz}$	C_{tot}	1.5	pF
Reverse Recovery Time at $I_F = I_R = 10\ \text{mA}, I_{rr} = 0.1 \times I_R, R_L = 100\ \Omega$	t_{rr}	4	ns

BAS316WS

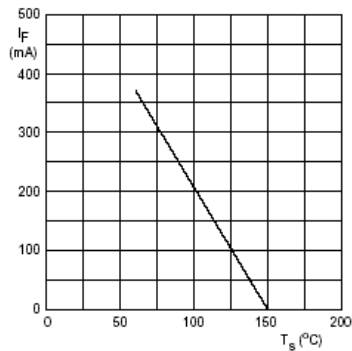
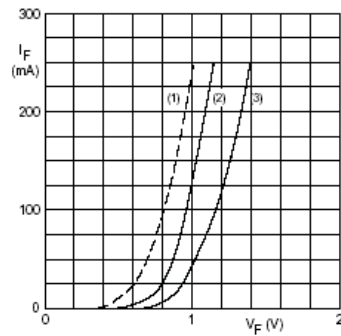
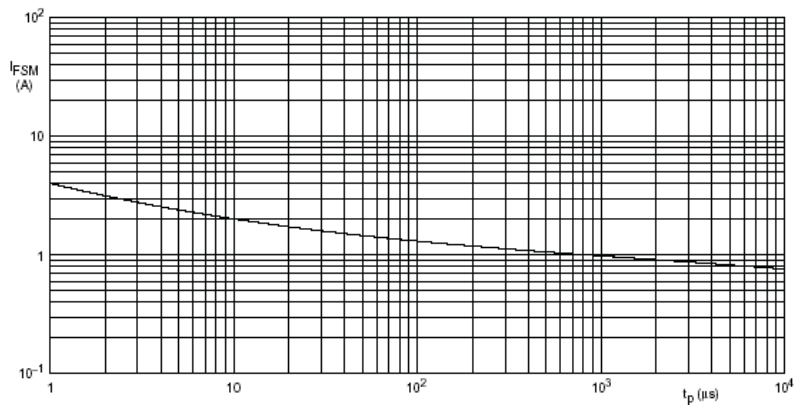

Fig. 1 Maximum permissible continuous forward current as a function of soldering point temperature.



(1) $T_j = 150^\circ\text{C}$; typical values.
 (2) $T_j = 25^\circ\text{C}$; typical values.
 (3) $T_j = 25^\circ\text{C}$; maximum values.

Fig. 2 Forward current as a function of forward voltage.



Based on square wave currents.
 $T_j = 25^\circ\text{C}$ prior to surge.

Fig. 3 Maximum permissible non-repetitive peak forward current as a function of pulse duration.

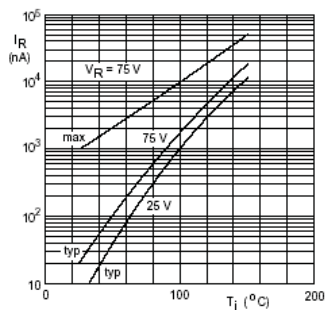
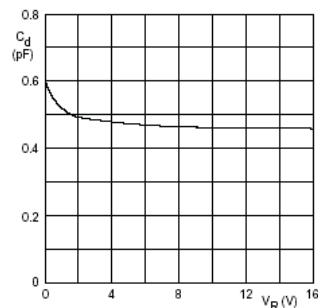

Fig. 4 Reverse current as a function of junction temperature.



$f = 1\text{ MHz}; T_j = 25^\circ\text{C}$.

Fig. 5 Diode capacitance as a function of reverse voltage; typical values.

BAS316WS PACKAGE OUTLINE

Plastic surface mounted package; 2 leads

SC-76

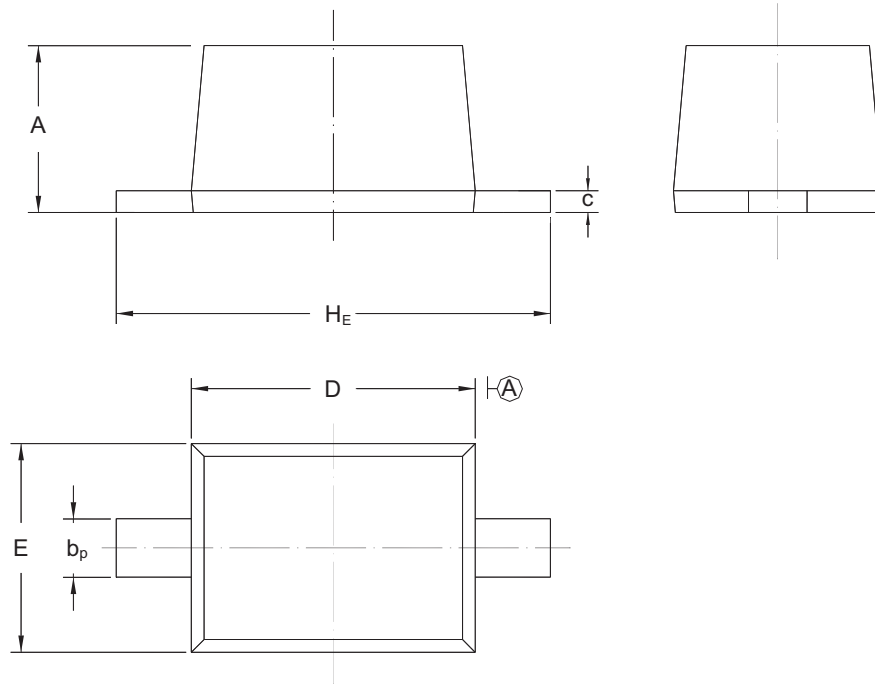

UNIT	A	b _p	C	D	E	H _E
mm	1.10 0.80	0.40 0.25	0.15 0.10	1.80 1.60	1.35 1.15	2.80 2.30