

Norky Wei

WhatsApp & Phone: +86 188 3028 9136

Wechat: 0086 183 3017 3287

Email:norky@deonpump.cn

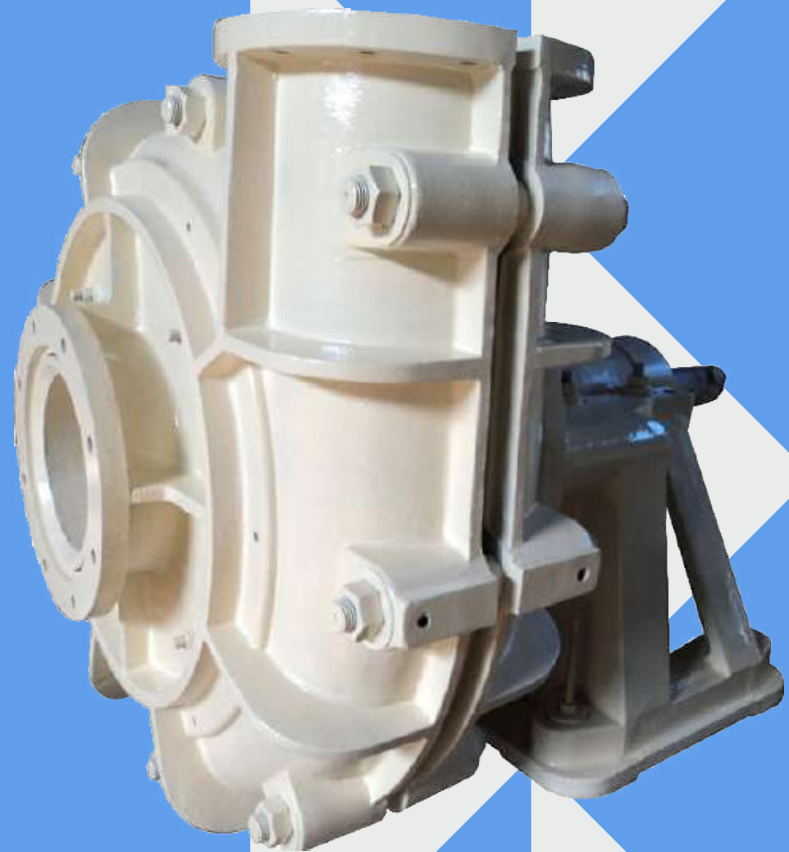

MAH SLURRY PUMPS

MAH HORIZONTAL SLURRY PUMPS

Heavy duty, horizontal slurry pumps. High efficiency transfer of abraive and high density slurries with extended

VERSATILE HEAVY DUTY SOLUTION

Depon MAH series pumps are heavy duty horizontal slurry pumps designed to handle the transfer of abraive and high density slurries in mining and heavy industry.

MAH pumps feature a rugged cast iron construction with replaceable wear liners available in 27% chrome white iron, rubber or urethane to suit a wide range of applications, slurry types and consistencies.

Pumps are available in sizes ranging from 1 inch (25mm) to 18 inch (450mm) discharge and feature high efficiency performance capable of flow rates from 10.8 to 6500 m³/hour (48-28600USGPM) and heads up to 125 metres (410ft) for high head models.

All Depon MAH slurry pumps are designed to be interchangeable with the most common slurry pump footprints used by the mining industry.

MAH pumps are manufactured using the highest quality materials to ensure reliability and extended service life in heavy duty applications.

MAH pumps are manufactured with a rugged cast iron outer casing which features reinforcing ribs for excellent high pressure strength and safety.

WEAR LINERS

A range of replaceable wear liners are available in 27% chrome white iron, rubber or urethane to suit the requirements of specific applications and slurry types. Wear liners are easily replaced when required by simply removing the front cover plate bolts and sliding off the front cover. This allows minimal downtime and simple servicing for maintenance staff.

IMPELLERS

The impeller features pumpout vanes on the rear face to prevent recirculation. Impellers are available in 27% chrome white iron or rubber to suit the requirements of the pumped product and are easily accessible by simply removing the front cover plate bolts and sliding off the front cover.

EXTERNAL IMPELLER ADJUSTMENT

An external impeller adjustment bolt is located under the bearing assembly and is easily accessible. This allows for changes to be made to the impeller clearance to maximise efficiency and service life without removing the front cover plate or disconnecting pipework or the bearing assembly. The system allows quick and simple adjustments to be made to compensate for wear and changes in operating conditions and duty points.

**DEPON MAH 2x1.5B
HORIZONTAL SLURRY PUMP**



DEPON 4x3EHH





MAH pumps are fitted with heavy duty bearing assemblies with angular contact bearings in the wet end and single or double row deep groove roller bearings in the drive end. Bearings are grease lubricated as standard and are available with the option of oil lubrication to meet customer requirements. Bearing assemblies are fitted to the bearing frame with four through bolts allowing for quick removal and simple servicing.

SHAFT SEALING OPTIONS

Pumps are fitted with packed gland type shaft seals as standard with PTFE packing and pumped product lubrication. Optional external clean water lubrication is available as an option to suit applications where product lubrication is not viable.

MECHANICAL SEAL

A range of mechanical seals are available to replace the packed gland shaft seal. Adaptor plates can be easily fitted to match the requirements of specific types of mechanical seals and seals are available in a wide range of materials.

EXPELLER

MAH pumps are fitted with an expeller as standard which reduces seal face pressure and reduces recirculation to extend seal life and reduce impeller wear.

100% INTERCHANGEABLE

All MAH spare parts are fully interchangeable with the most common slurry pump design in the mining industry. High quality Milestone spare parts can be fitted into existing pumps to improve performance and extend service life.

MAH
Horizontal Slurry
Pumps are 100% fully
interchangeable with
the most common
slurry pump design in
the mining industry.

PUMP PERFORMANCE

RUBBER LINED PUMPS

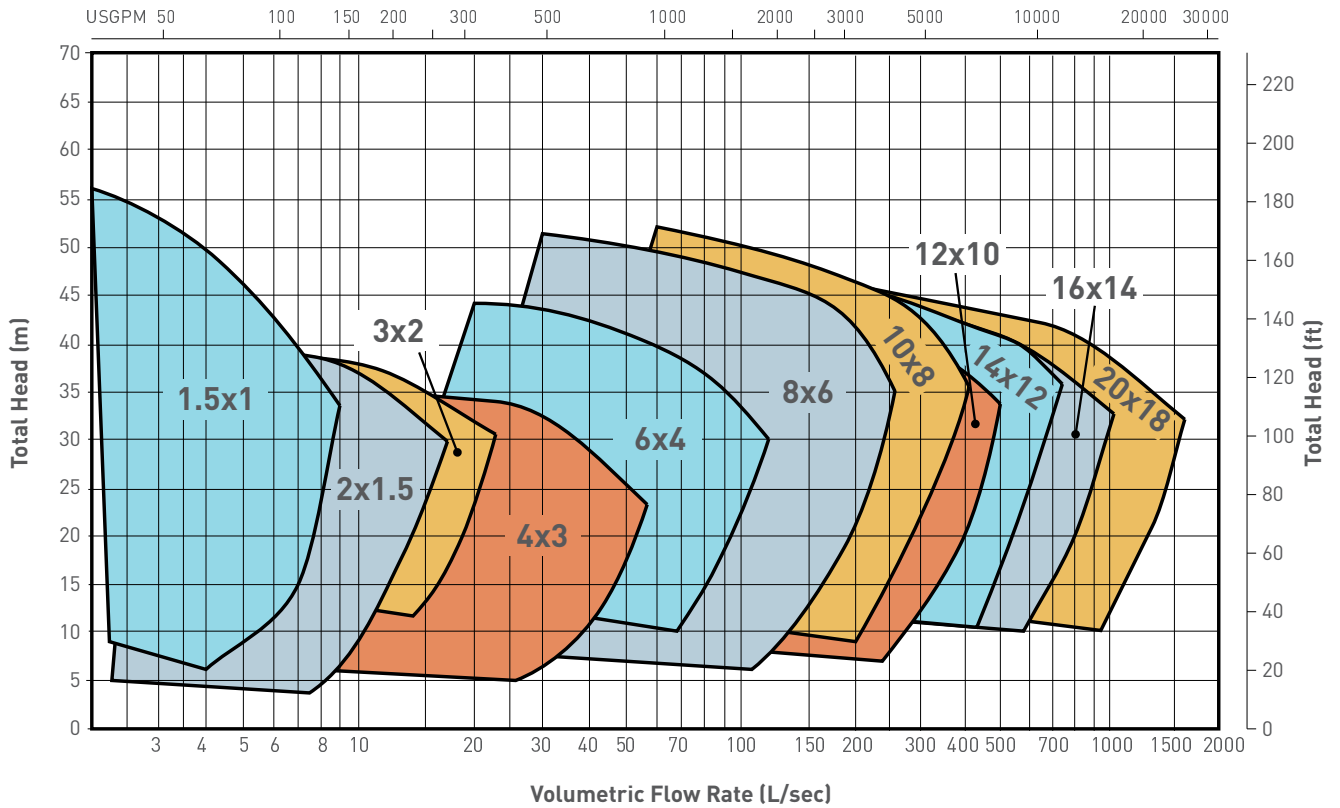

METAL LINED PUMPS

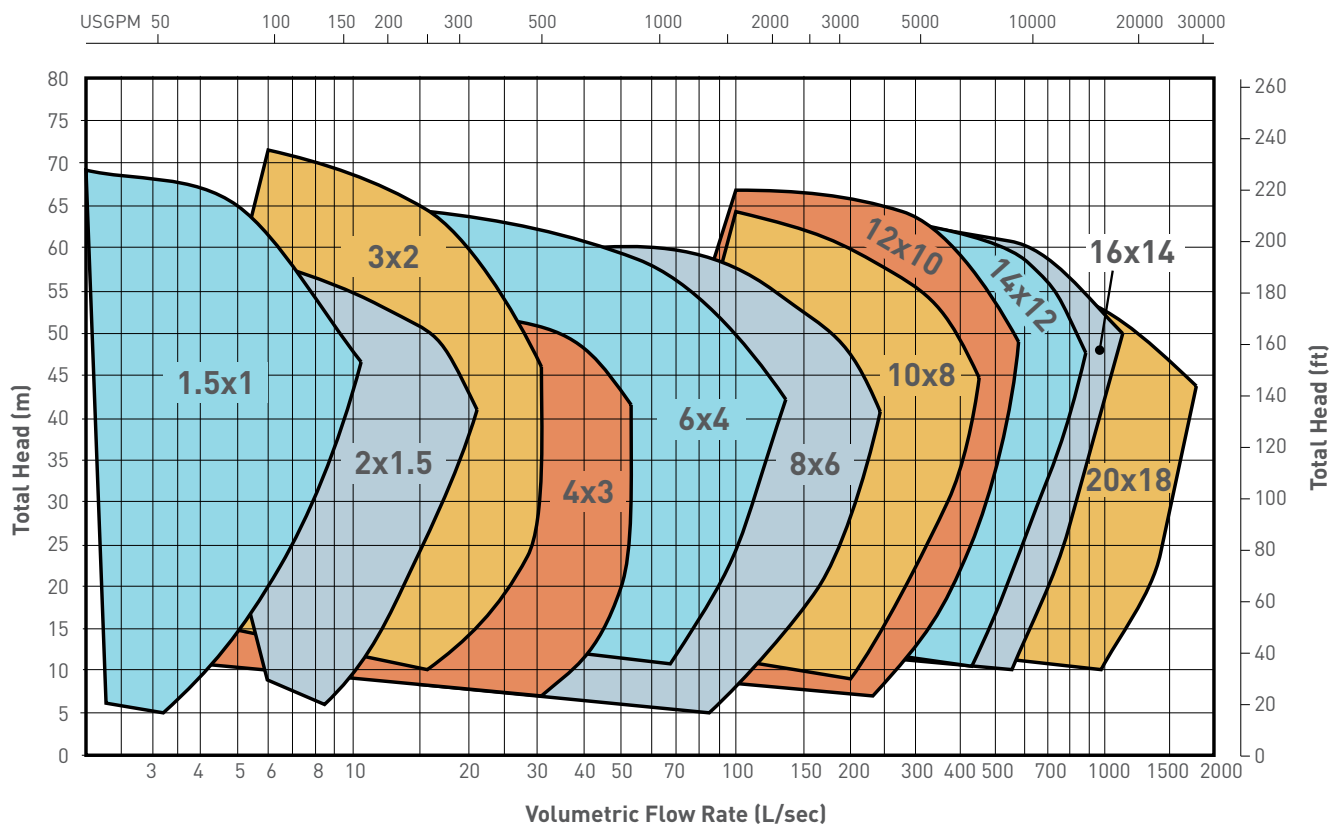

Performance curves are for clean, cold water only. Contact us to discuss pump selections for specific applications.

HIGH HEAD PUMPS

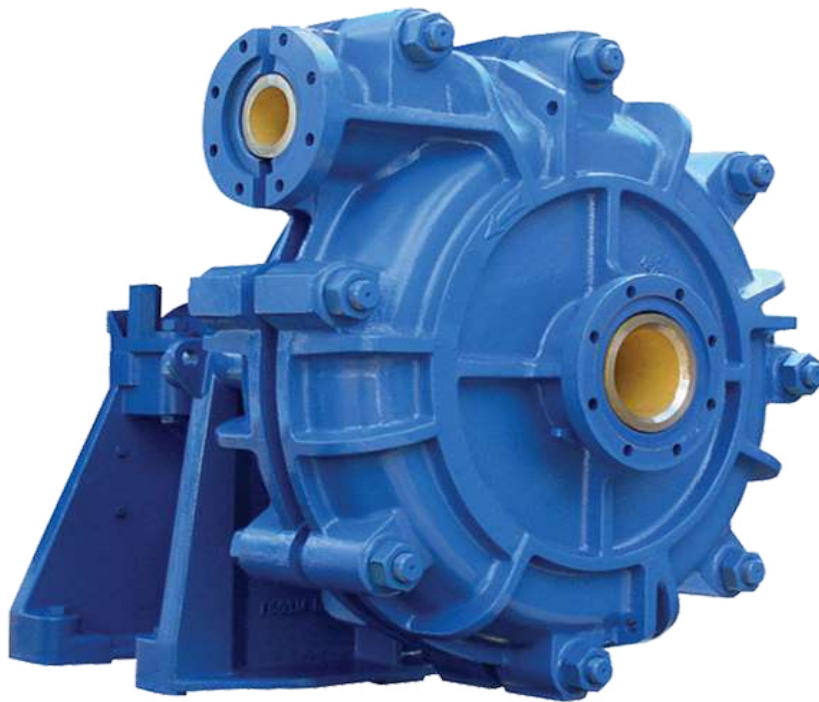
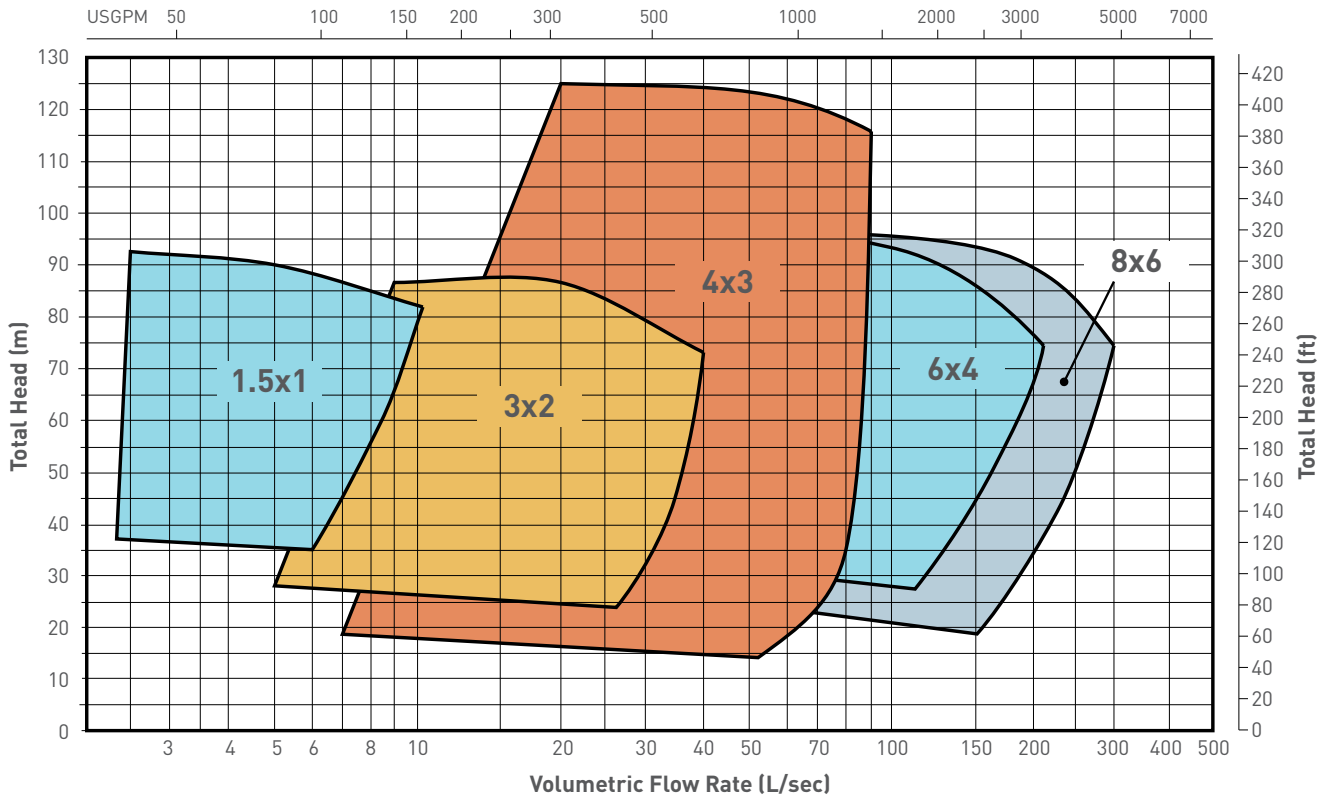

**DEPON 6x4FHH
HIGH HEAD SLURRY PUMP.**

MAH 1.5x1

METAL LINER AND IMPELLER

PUMP SPECIFICATIONS

Outlet/ Inlet (mm)	Bearing Frame	Max Power (kW)	Max Particle Size (mm)	Impeller	No. of Vanes	Impeller Material	Impeller/ Vane Dia. (mm)	Wear Liner Material
32/25	B	15	14	B1127	5	27% Chrome White Iron	159/152	27% Chrome White Iron

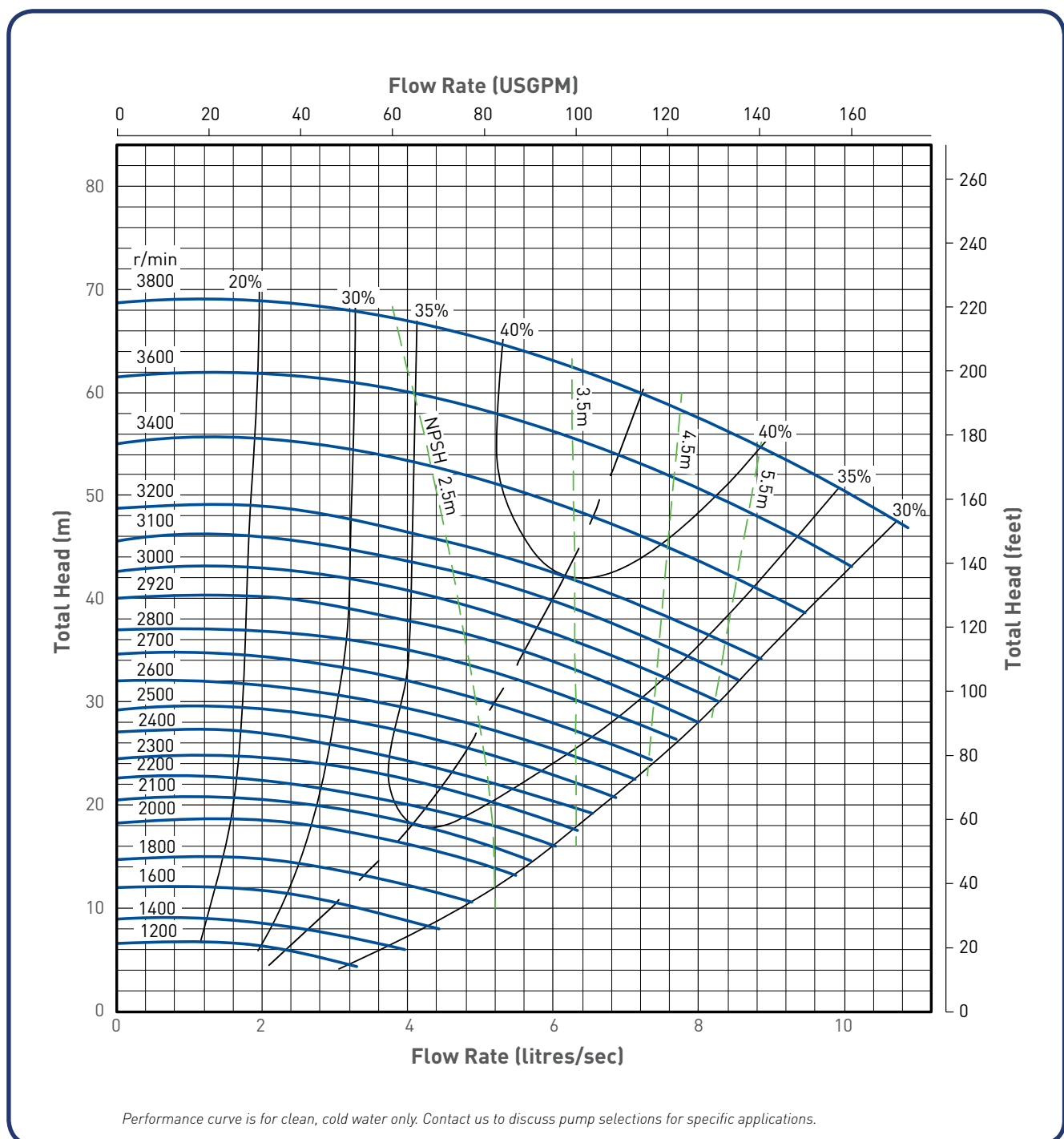

MAH 1.5x1

RUBBER LINER AND IMPELLER

PUMP SPECIFICATIONS

Outlet/ Inlet (mm)	Bearing Frame	Max Power (kW)	Max Particle Size (mm)	Impeller	No. of Vanes	Impeller Material	Impeller/ Vane Dia. (mm)	Wear Liner Material
32/25	B	15	20	B1052	5	Rubber Lined High Tensile Steel	159/152	Rubber

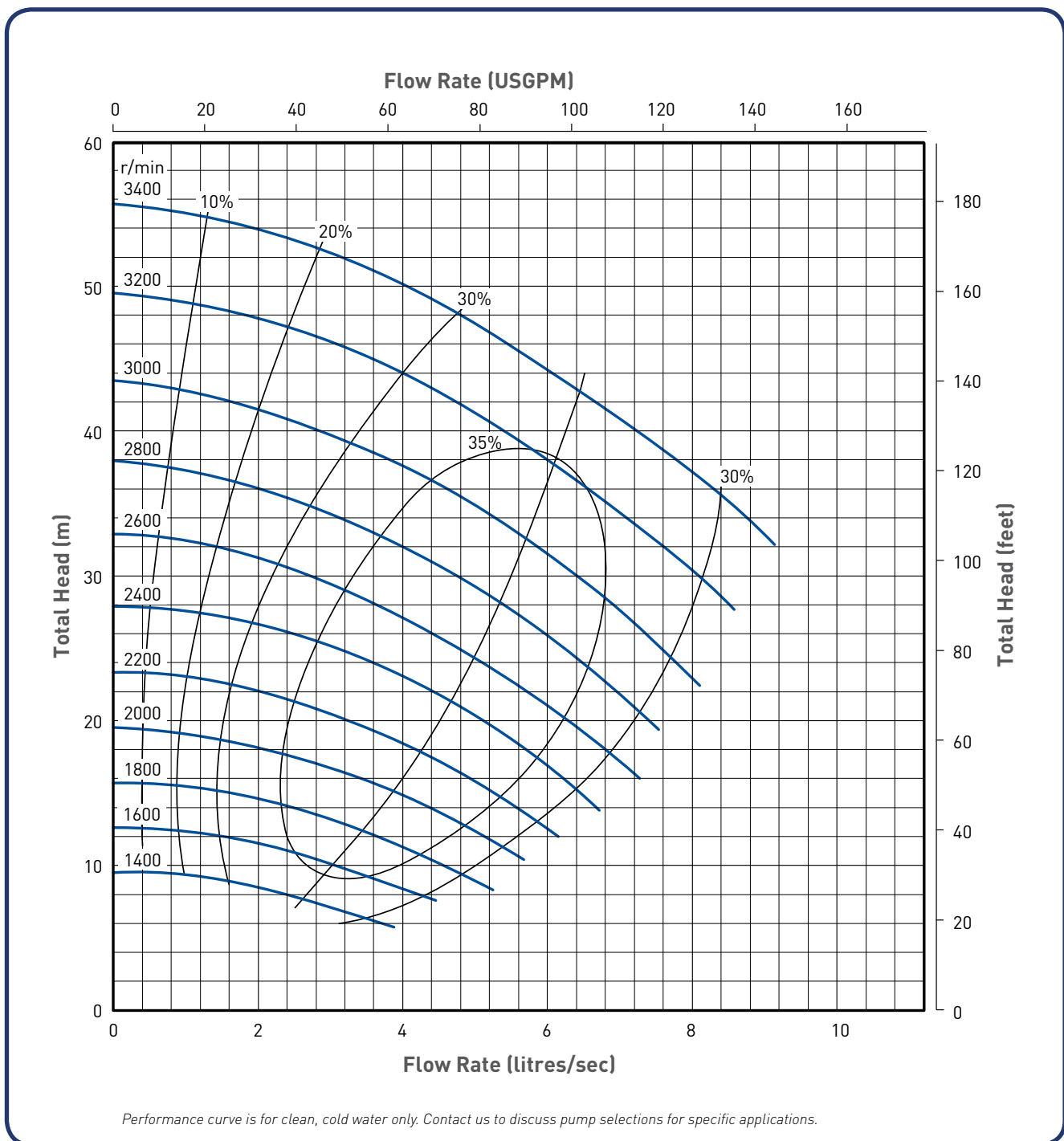

MHH 1.5x1

HIGH HEAD SLURRY PUMP

PUMP SPECIFICATIONS

Outlet/ Inlet (mm)	Bearing Frame	Max Power (kW)	Max Particle Size (mm)	Impeller	No. of Vanes	Impeller Material	Impeller/ Vane Dia. (mm)	Wear Liner Material
32/25	C	30	16	MCH1127	5	27% Chrome White Iron	343/330	27% Chrome White Iron

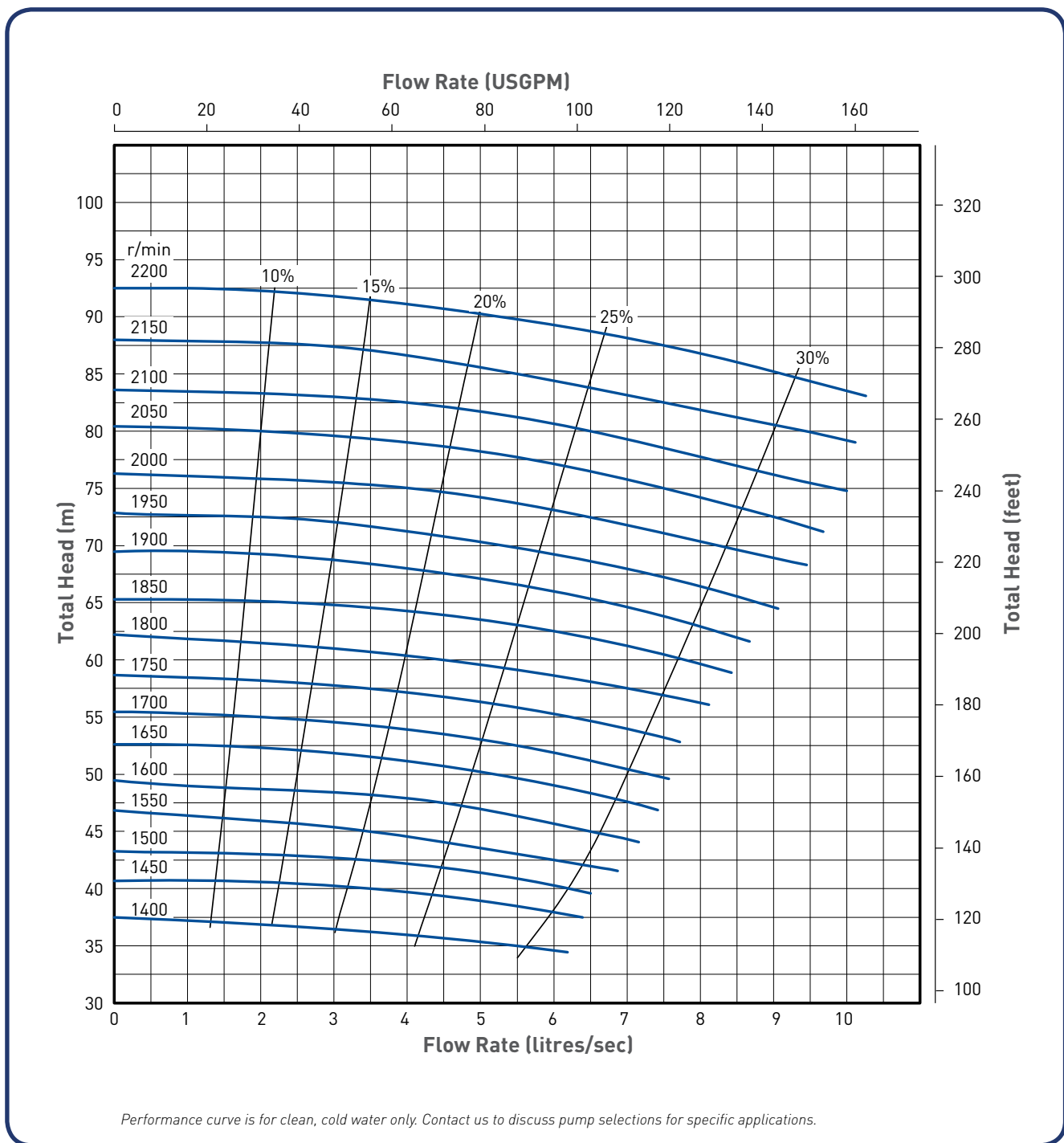

MAH 2x1.5

METAL LINER AND IMPELLER

PUMP SPECIFICATIONS

Outlet/ Inlet (mm)	Bearing Frame	Max Power (kW)	Max Particle Size (mm)	Impeller	No. of Vanes	Impeller Material	Impeller/ Vane Dia. (mm)	Wear Liner Material
50/32	B	15	19	B15127	5	27% Chrome White Iron	184	27% Chrome White Iron

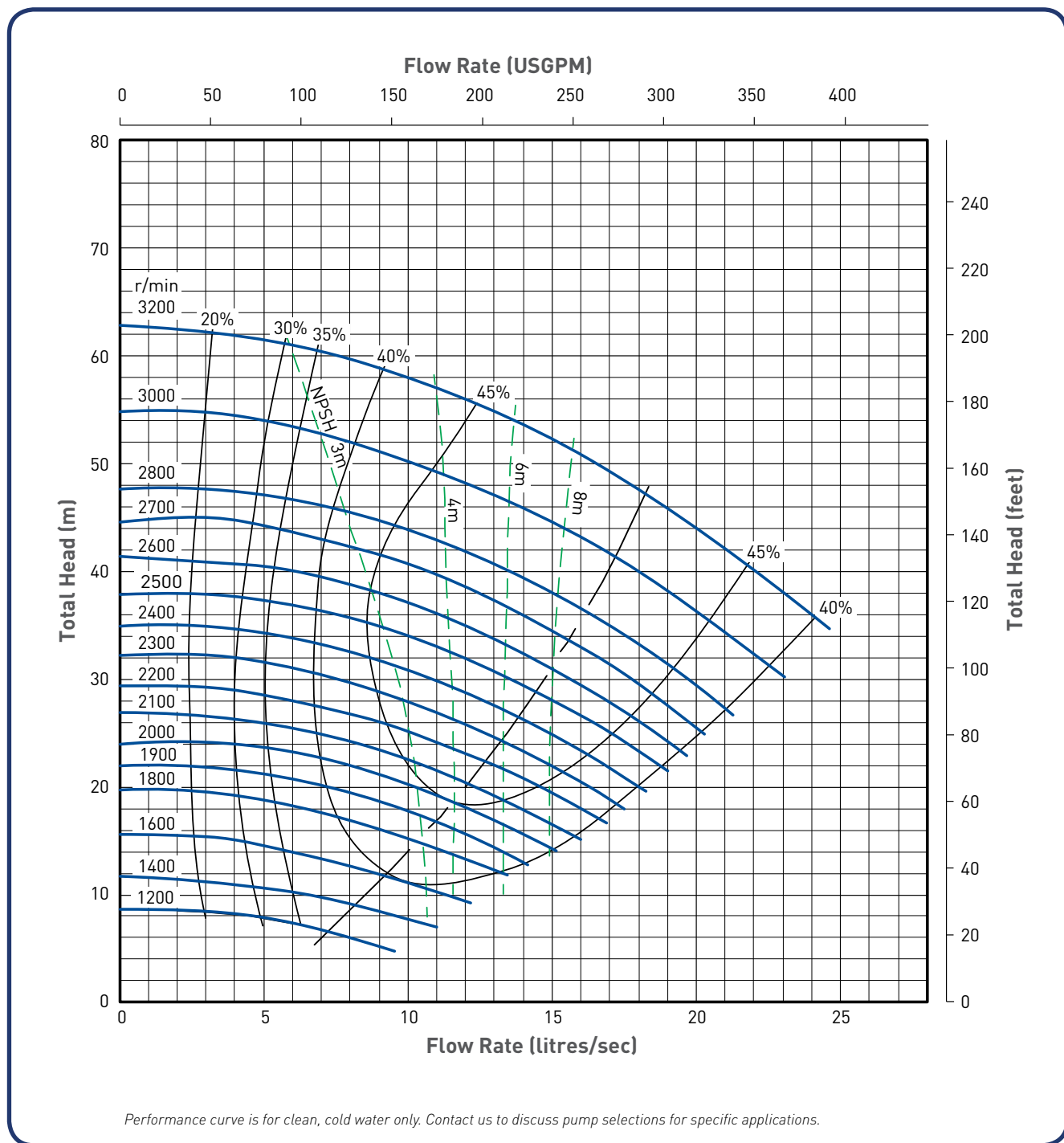

MAH 2x1.5

RUBBER LINER AND IMPELLER

PUMP SPECIFICATIONS

Outlet/ Inlet (mm)	Bearing Frame	Max Power (kW)	Max Particle Size (mm)	Impeller	No. of Vanes	Impeller Material	Impeller/ Vane Dia. (mm)	Wear Liner Material
50/32	B	15	16	B15127	5	Rubber Lined High Tensile Steel	180	Rubber

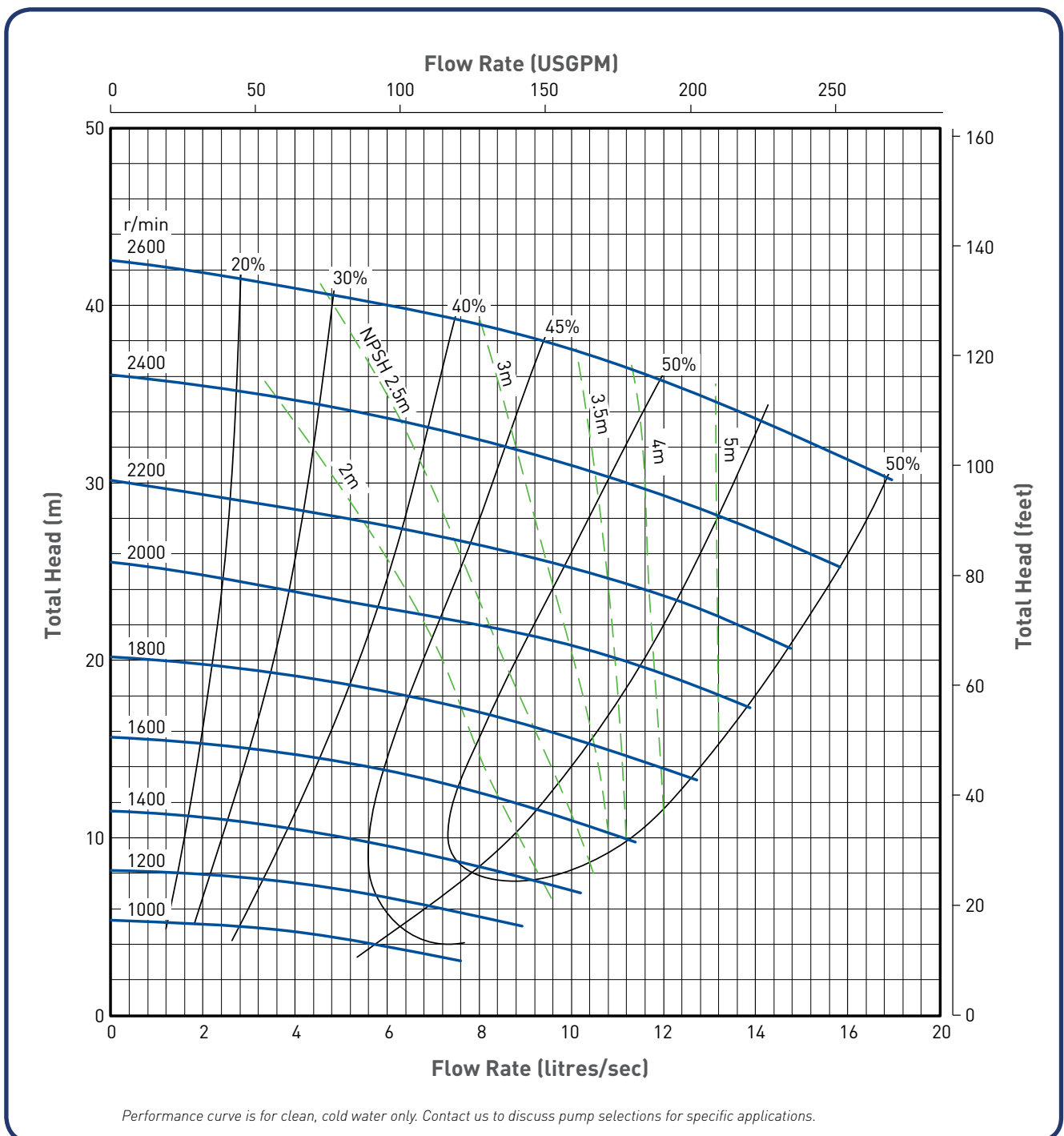

MAH 3x2

METAL LINER AND IMPELLER

PUMP SPECIFICATIONS

Outlet/ Inlet (mm)	Bearing Frame	Max Power (kW)	Max Particle Size (mm)	Impeller	No. of Vanes	Impeller Material	Impeller/ Vane Dia. (mm)	Wear Liner Material
75/50	C	30	25	C2147	5	27% Chrome White Iron	214	27% Chrome White Iron

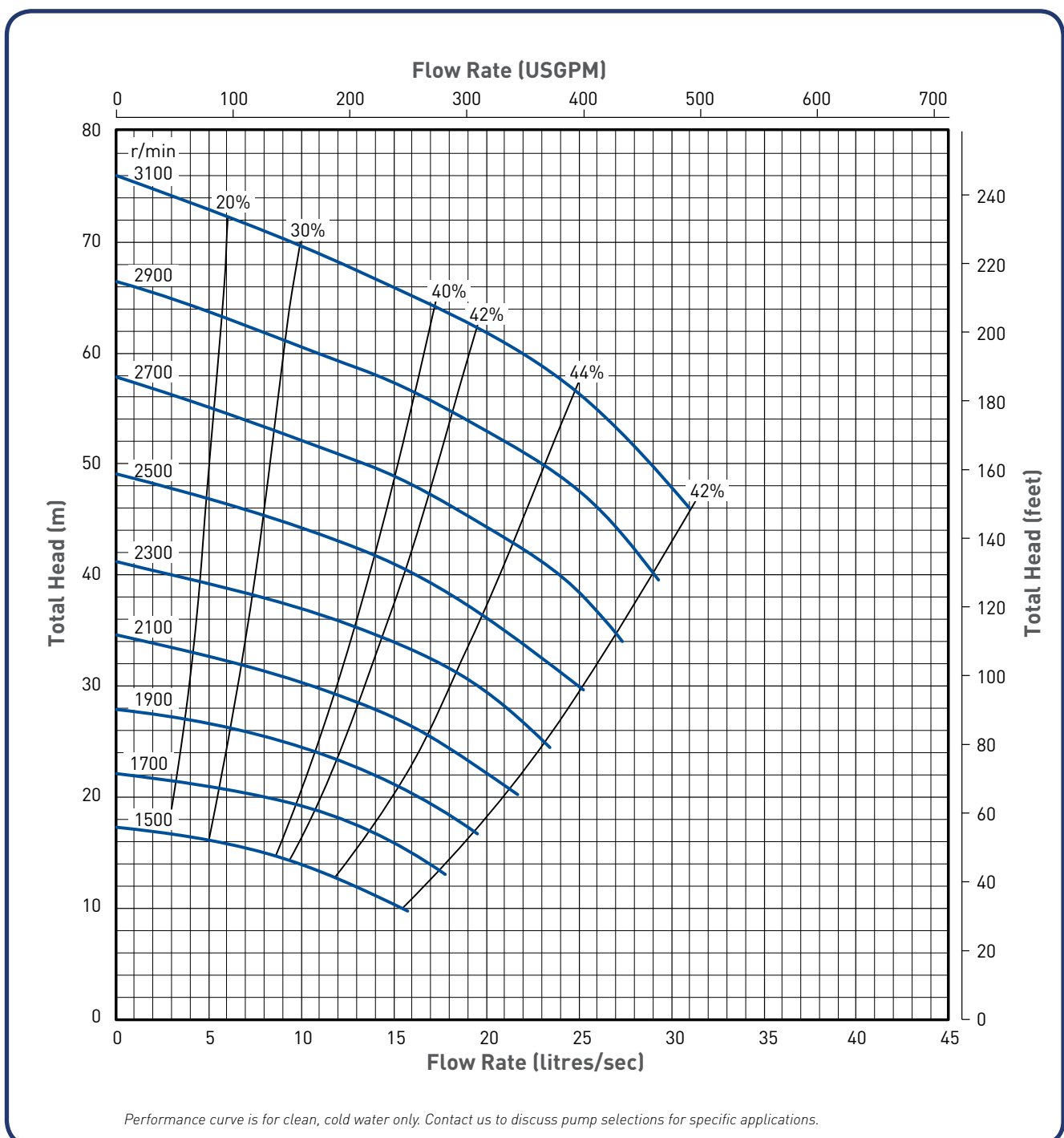

MAH 3x2

RUBBER LINER AND IMPELLER

PUMP SPECIFICATIONS

Outlet/ Inlet (mm)	Bearing Frame	Max Power (kW)	Max Particle Size (mm)	Impeller	No. of Vanes	Impeller Material	Impeller/ Vane Dia. (mm)	Wear Liner Material
75/50	C	30	21	C2127	5	Rubber Lined High Tensile Steel	215	Rubber

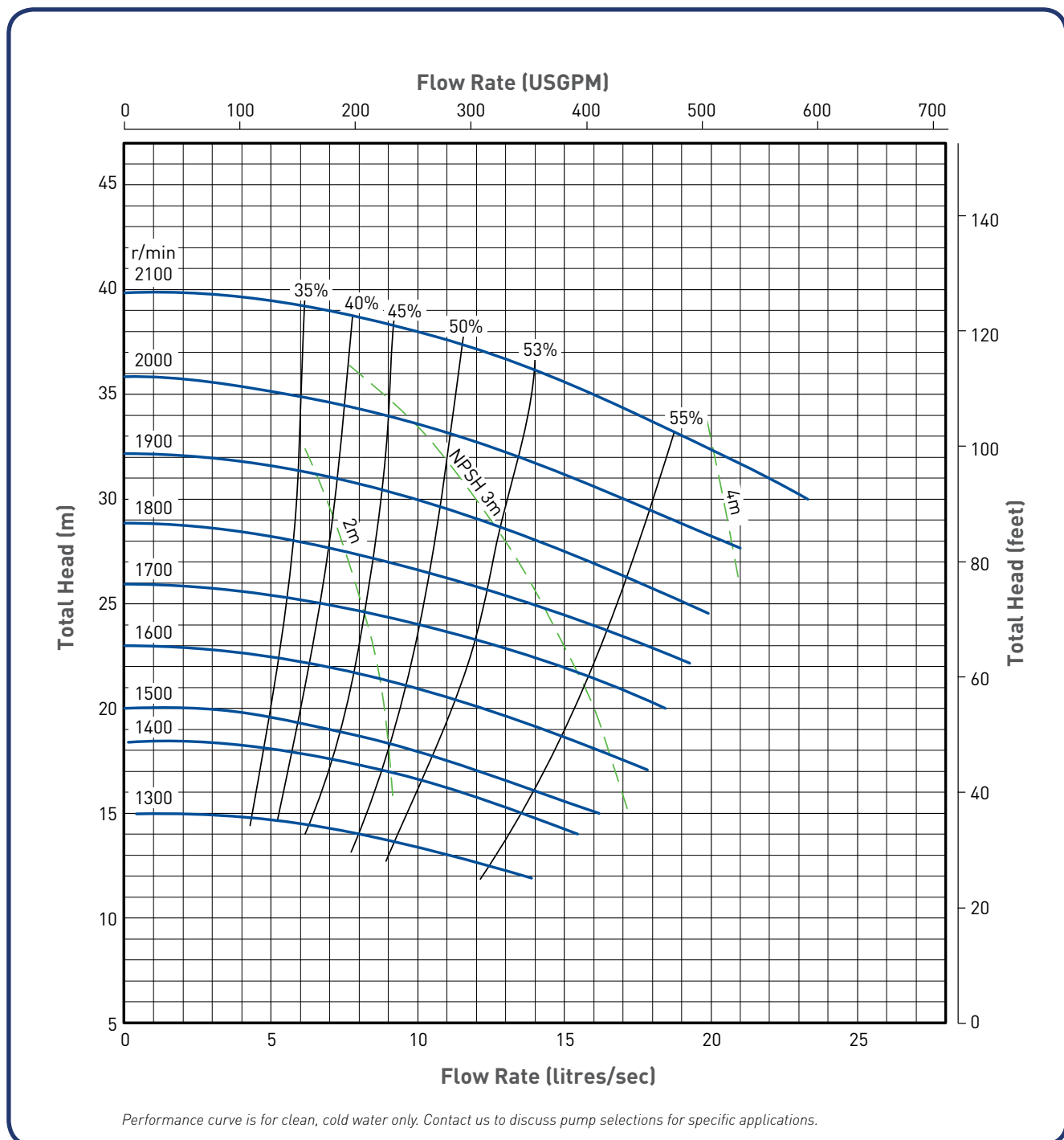

Performance curve is for clean, cold water only. Contact us to discuss pump selections for specific applications.

MHH 3x2

HIGH HEAD SLURRY PUMP

PUMP SPECIFICATIONS

Outlet/ Inlet (mm)	Bearing Frame	Max Power (kW)	Max Particle Size (mm)	Impeller	No. of Vaness	Impeller Material	Impeller/ Vane Dia. (mm)	Wear Liner Material
75/50	D	60	31	MDH2147	5	27% Chrome White Iron	476/457	27% Chrome White Iron
	X (320)	60						

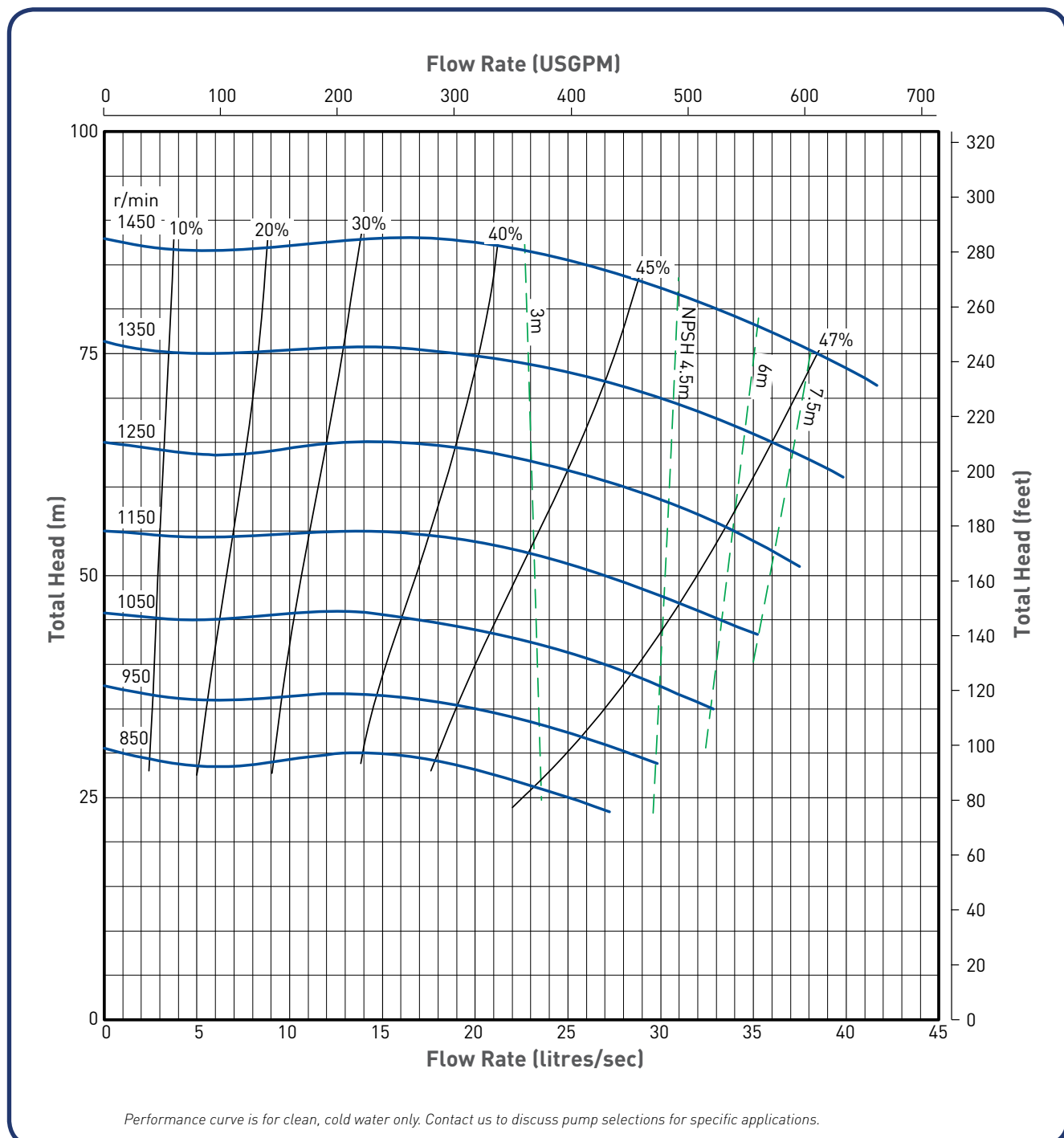

MAH 4x3

METAL LINER AND IMPELLER

PUMP SPECIFICATIONS

Outlet/ Inlet (mm)	Bearing Frame	Max Power (kW)	Max Particle Size (mm)	Impeller	No. of Vanes	Impeller Material	Impeller/ Vane Dia. (mm)	Wear Liner Material
100/75	C	60	18	D3147	5	27% Chrome White Iron	245	27% Chrome White Iron
	D	30						

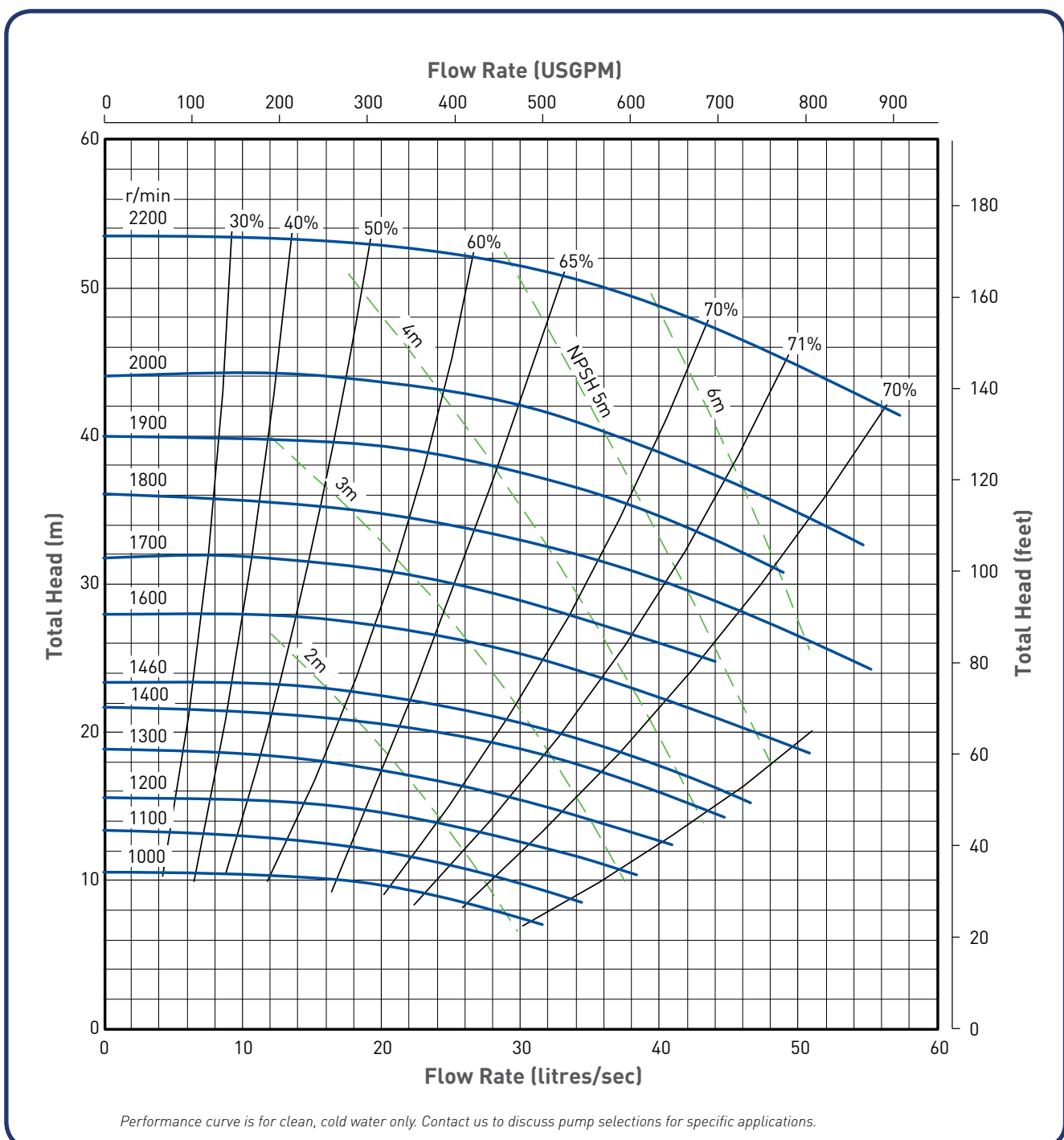

MAH 4x3

RUBBER LINER AND IMPELLER

PUMP SPECIFICATIONS

Outlet/ Inlet (mm)	Bearing Frame	Max Power (kW)	Max Particle Size (mm)	Impeller	No. of Vanes	Impeller Material	Impeller/ Vane Dia. (mm)	Wear Liner Material
100/75	C	30	28	D3147	5	Rubber Lined High Tensile Steel	245	Rubber

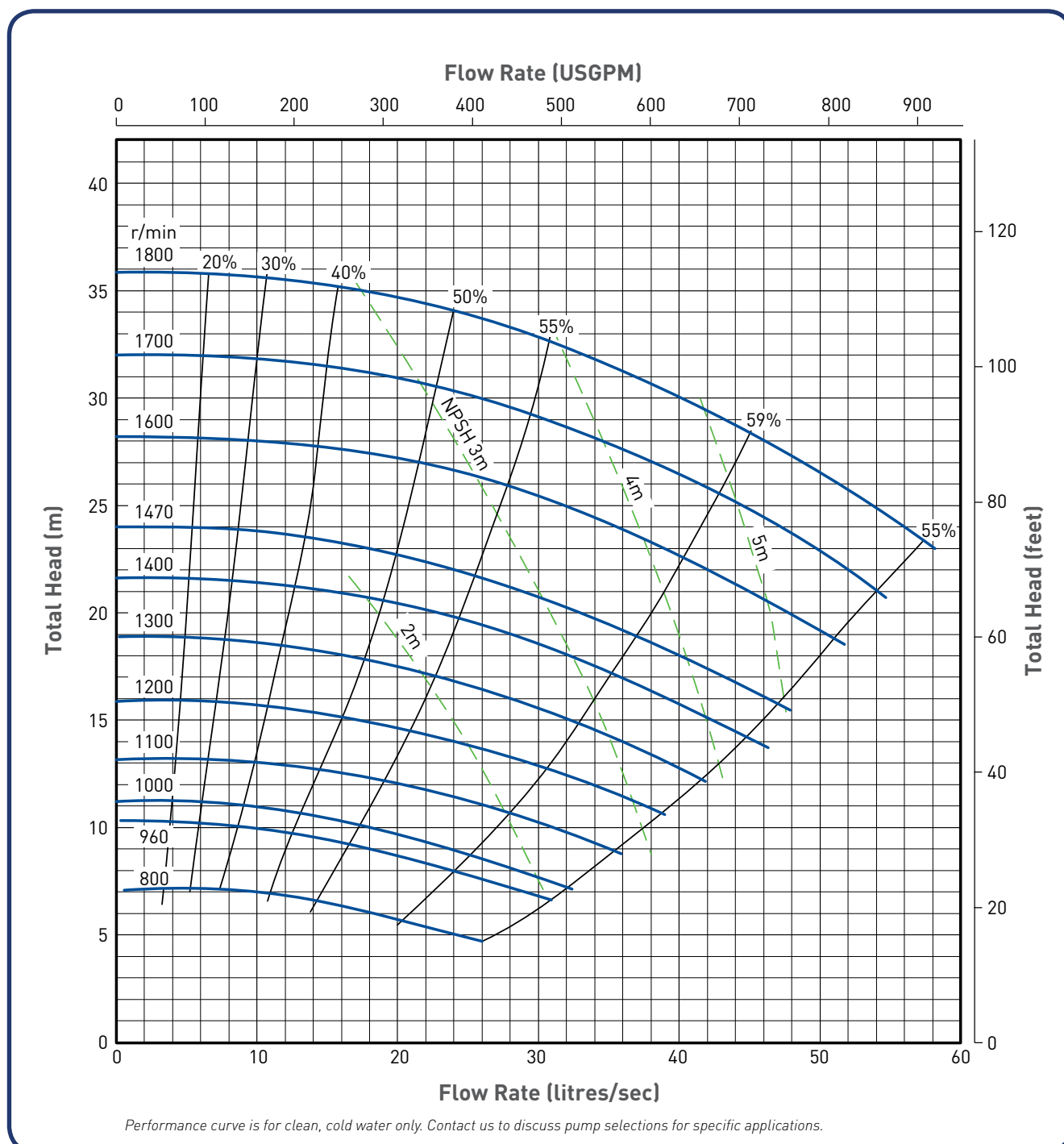

MHH 4x3

HIGH HEAD SLURRY PUMP

PUMP SPECIFICATIONS

Outlet/ Inlet (mm)	Bearing Frame	Max Power (kW)	Max Particle Size (mm)	Impeller	No. of Vanes	Impeller Material	Impeller/ Vane Dia. (mm)	Wear Liner Material
100/75	E	120	38	MEH3147	5	27% Chrome White Iron	518/508	27% Chrome White Iron
	X (406)	300						

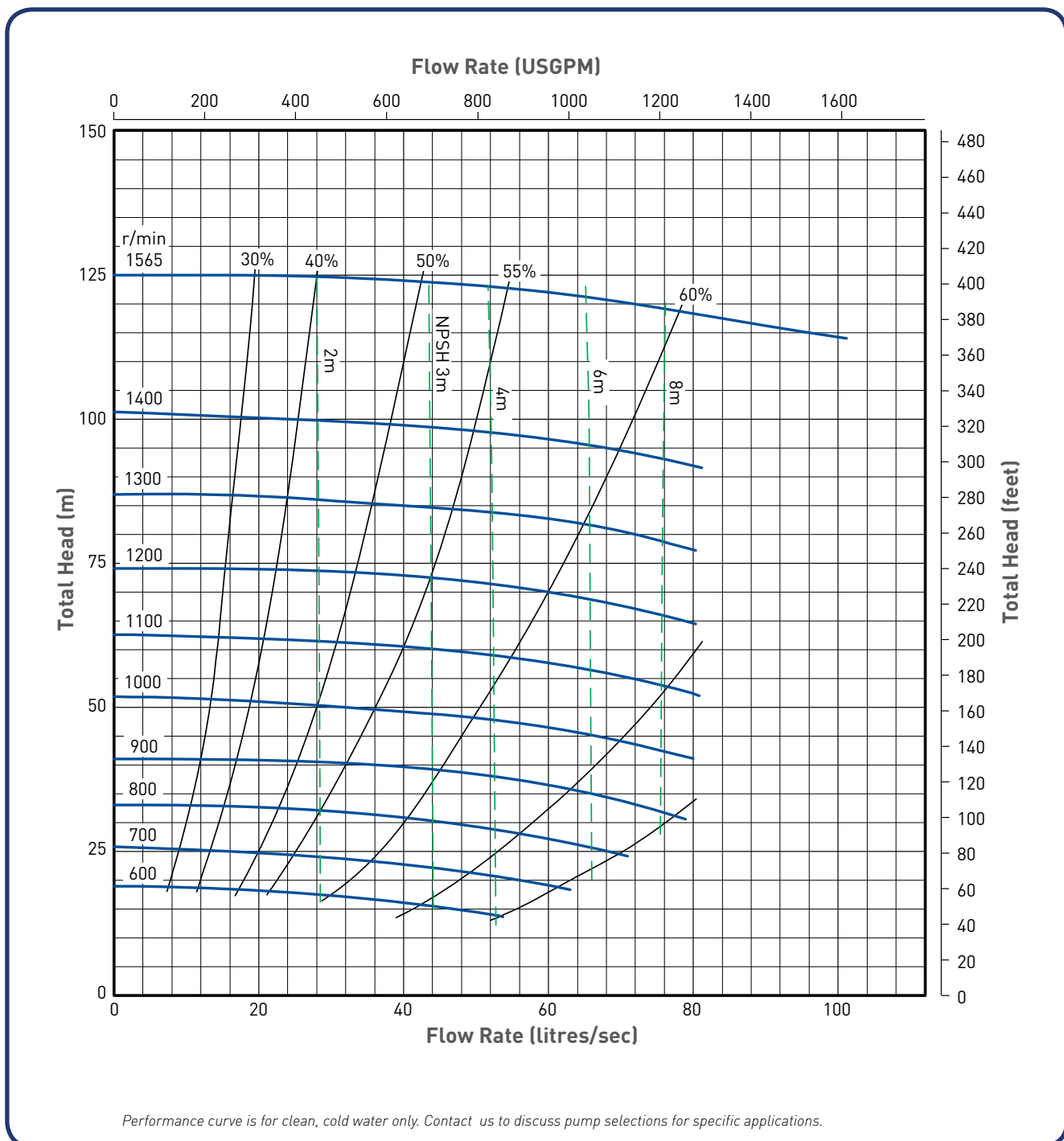

MAH 6x4

METAL LINER AND IMPELLER

PUMP SPECIFICATIONS

Outlet/ Inlet (mm)	Bearing Frame	Max Power (kW)	Max Particle Size (mm)	Impeller	No. of Vanes	Impeller Material	Impeller/ Vane Dia. (mm)	Wear Liner Material
150/100	D	60	44	E4147	5	27% Chrome White Iron	397/365	27% Chrome White Iron
	E	120						
	X (406)	300						

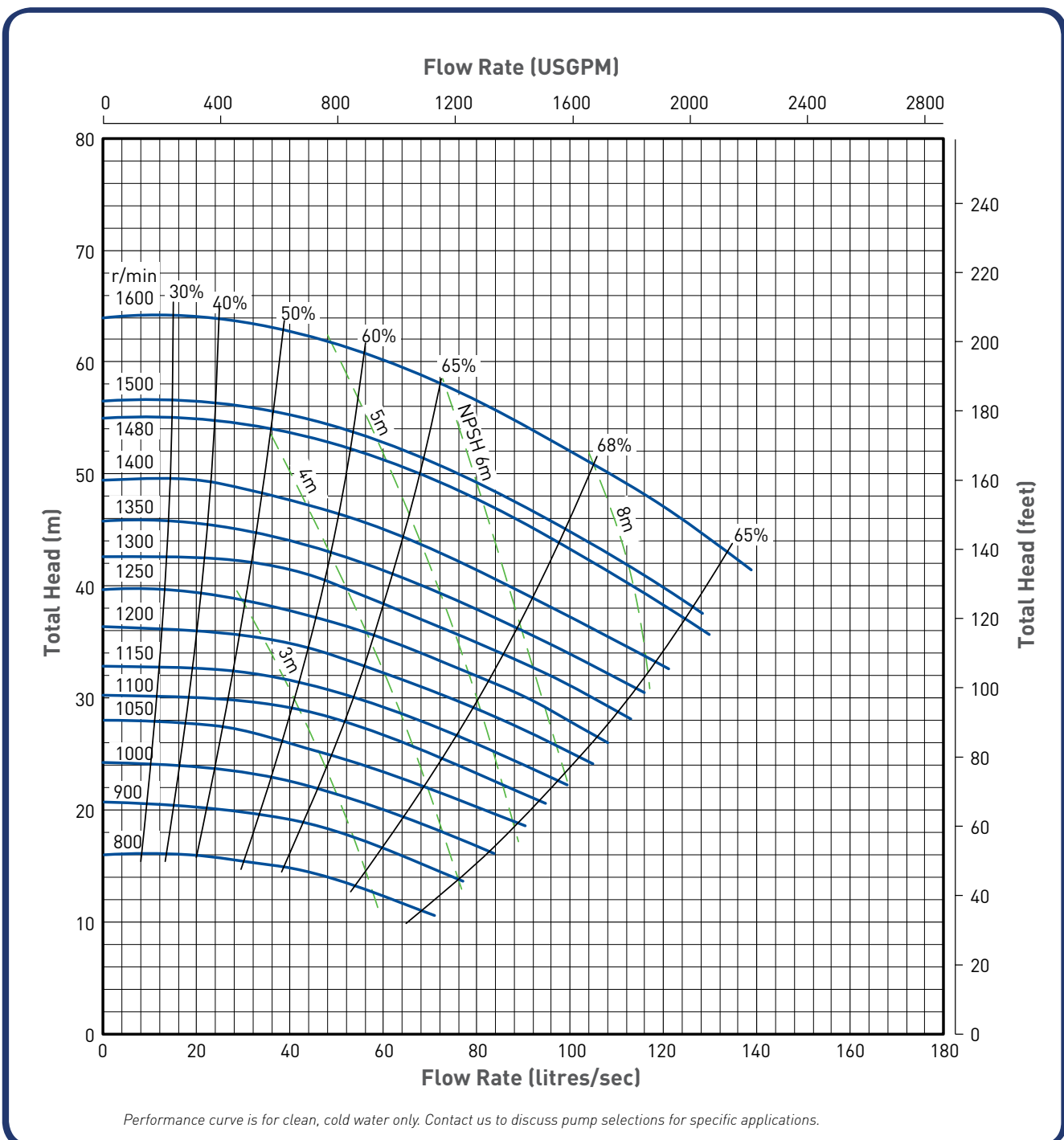

MAH 6x4

RUBBER LINER AND IMPELLER

PUMP SPECIFICATIONS

Outlet/ Inlet (mm)	Bearing Frame	Max Power (kW)	Max Particle Size (mm)	Impeller	No. of Vanes	Impeller Material	Impeller/ Vane Dia. (mm)	Wear Liner Material
150/100	D	60	33	E4147	5	Rubber Lined High Tensile Steel	397/365	Rubber
	E	120						

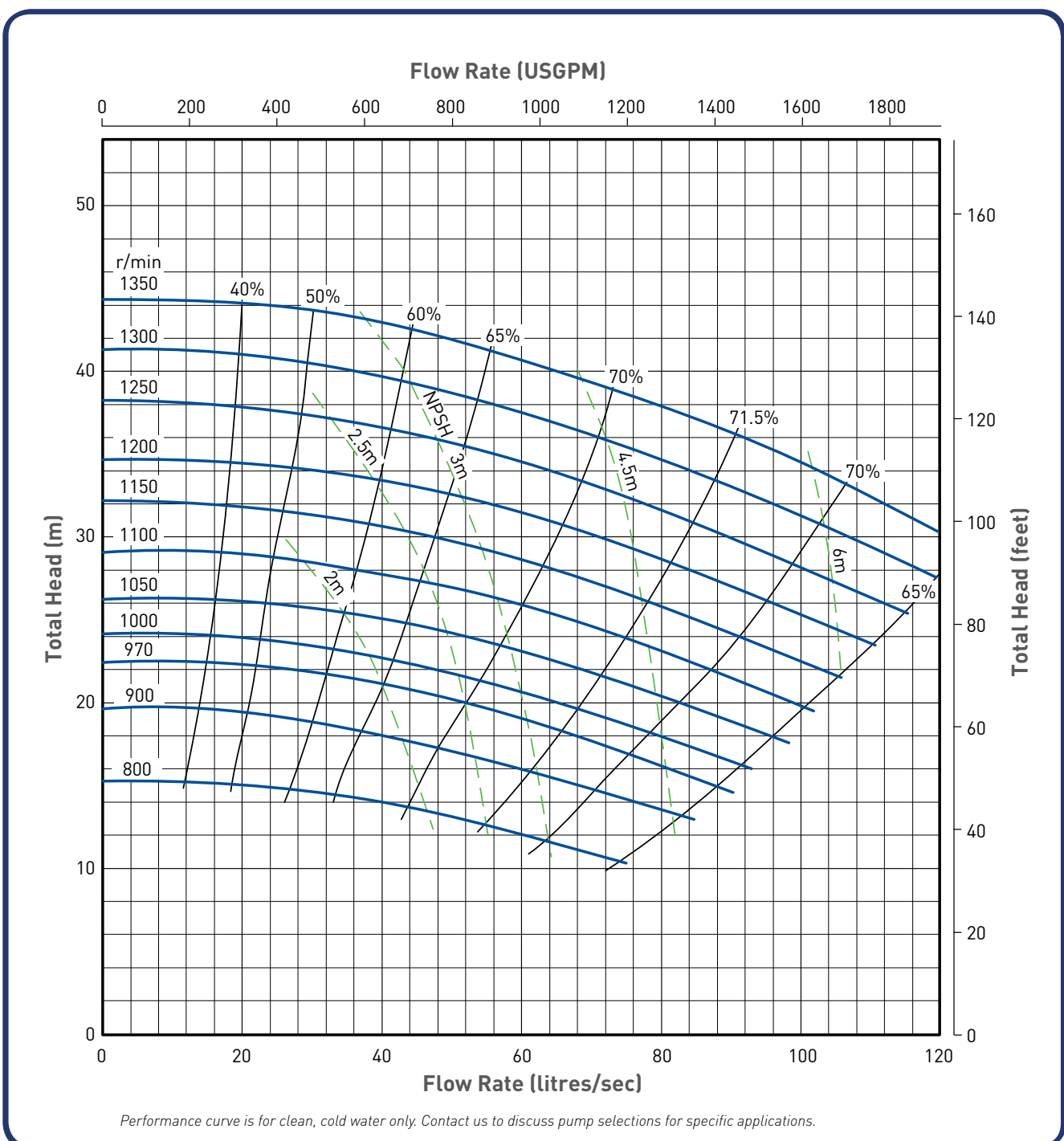

Performance curve is for clean, cold water only. Contact us to discuss pump selections for specific applications.

MHH 6x4

HIGH HEAD SLURRY PUMP

PUMP SPECIFICATIONS

Outlet/ Inlet (mm)	Bearing Frame	Max Power (kW)	Max Particle Size (mm)	Impeller	No. of Vanes	Impeller Material	Impeller/ Vane Dia. (mm)	Wear Liner Material
150/100	F	260	57	MFH4147	5	27% Chrome White Iron	730/709	27% Chrome White Iron

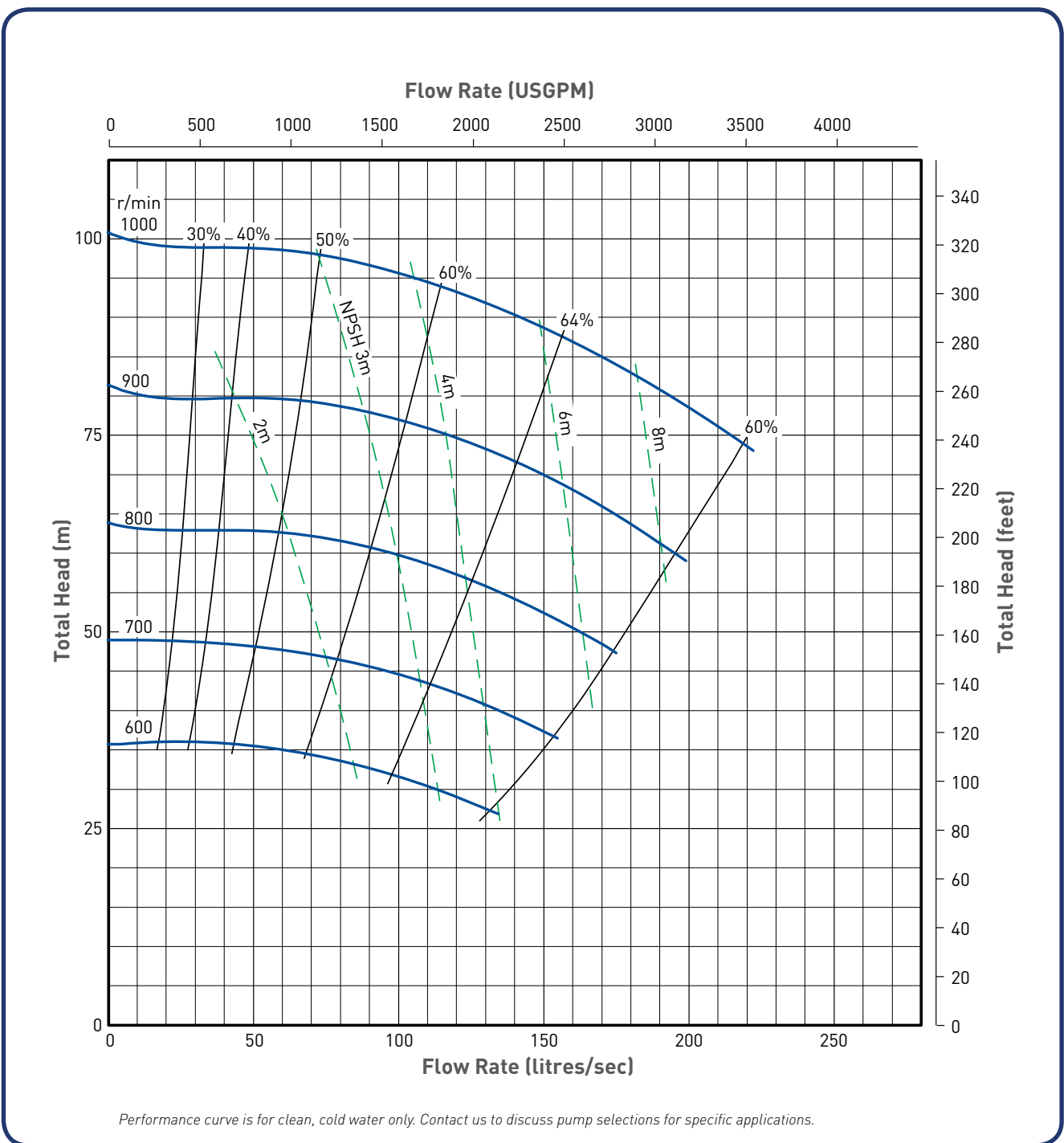

MAH 8x6

METAL LINER AND IMPELLER

PUMP SPECIFICATIONS

Outlet/ Inlet (mm)	Bearing Frame	Max Power (kW)	Max Particle Size (mm)	Impeller	No. of Vanes	Impeller Material	Impeller/ Vane Dia. (mm)	Wear Liner Material
200/150	E	120	63	F6147	5	27% Chrome White Iron	510	27% Chrome White Iron
	R	300						
	X (406)	300						

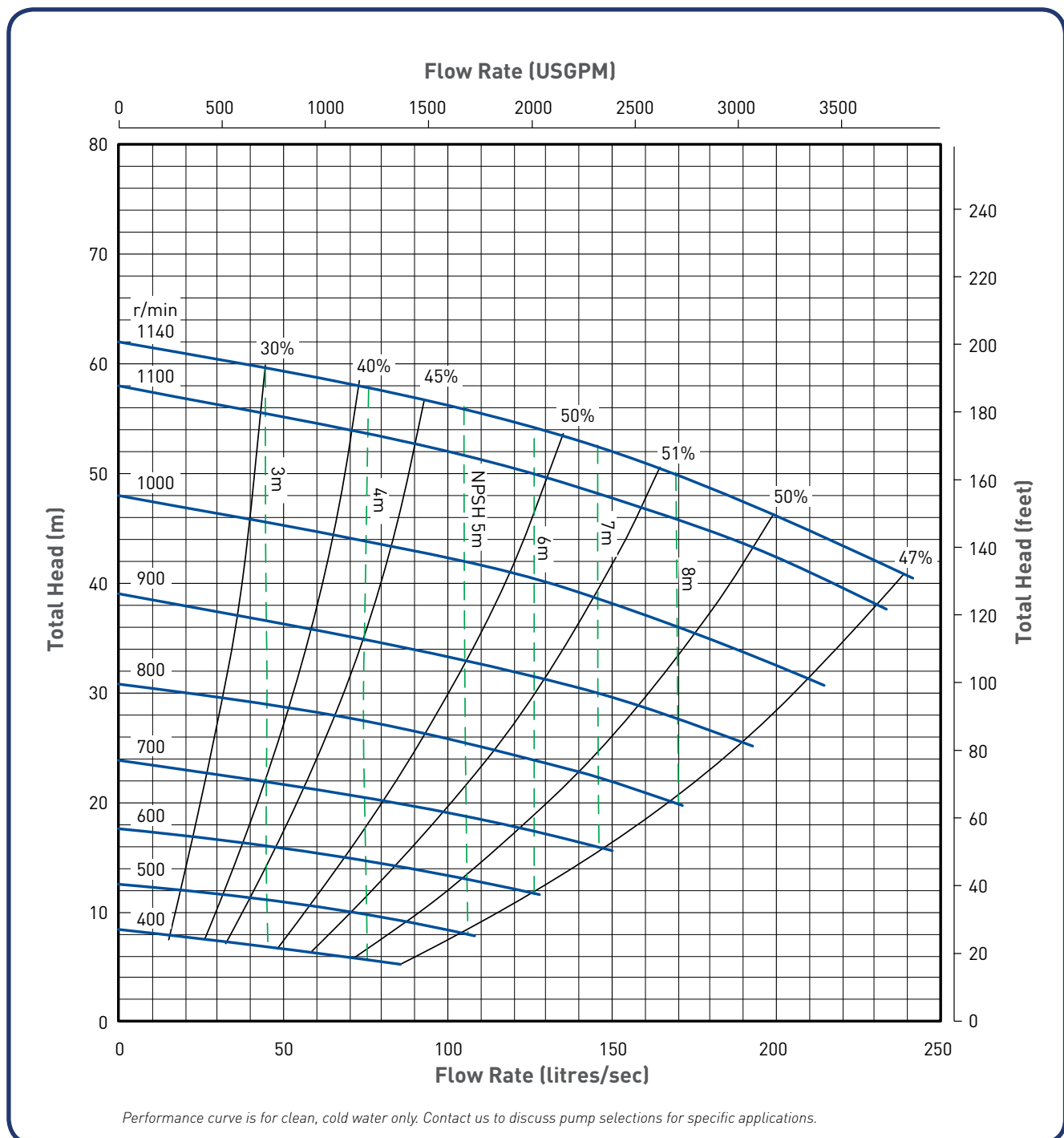

MAH 8x6

RUBBER LINER AND IMPELLER

PUMP SPECIFICATIONS

Outlet/ Inlet (mm)	Bearing Frame	Max Power (kW)	Max Particle Size (mm)	Impeller	No. of Vanes	Impeller Material	Impeller/ Vane Dia. (mm)	Wear Liner Material
200/150	E	120	59	F6147	5	Rubber Lined High Tensile Steel	510	Rubber
	R	300						

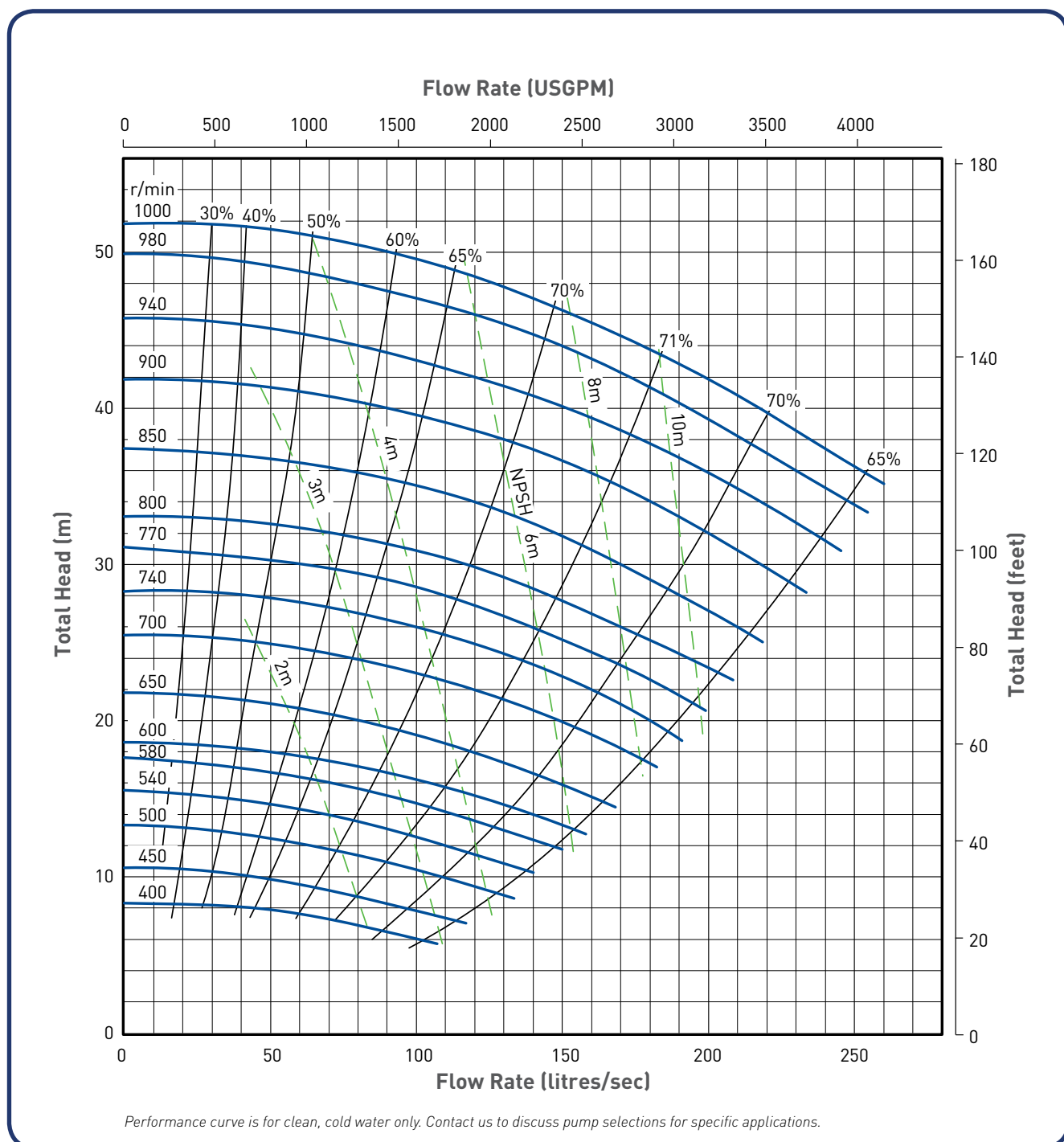

MHH 8x6

HIGH HEAD SLURRY PUMP

PUMP SPECIFICATIONS

Outlet/ Inlet (mm)	Bearing Frame	Max Power (kW)	Max Particle Size (mm)	Impeller	No. of Vanes	Impeller Material	Impeller/ Vane Dia. (mm)	Wear Liner Material
200/150	S	560	70	FH6145	5	27% Chrome White Iron	740/711	27% Chrome White Iron
	T	560						

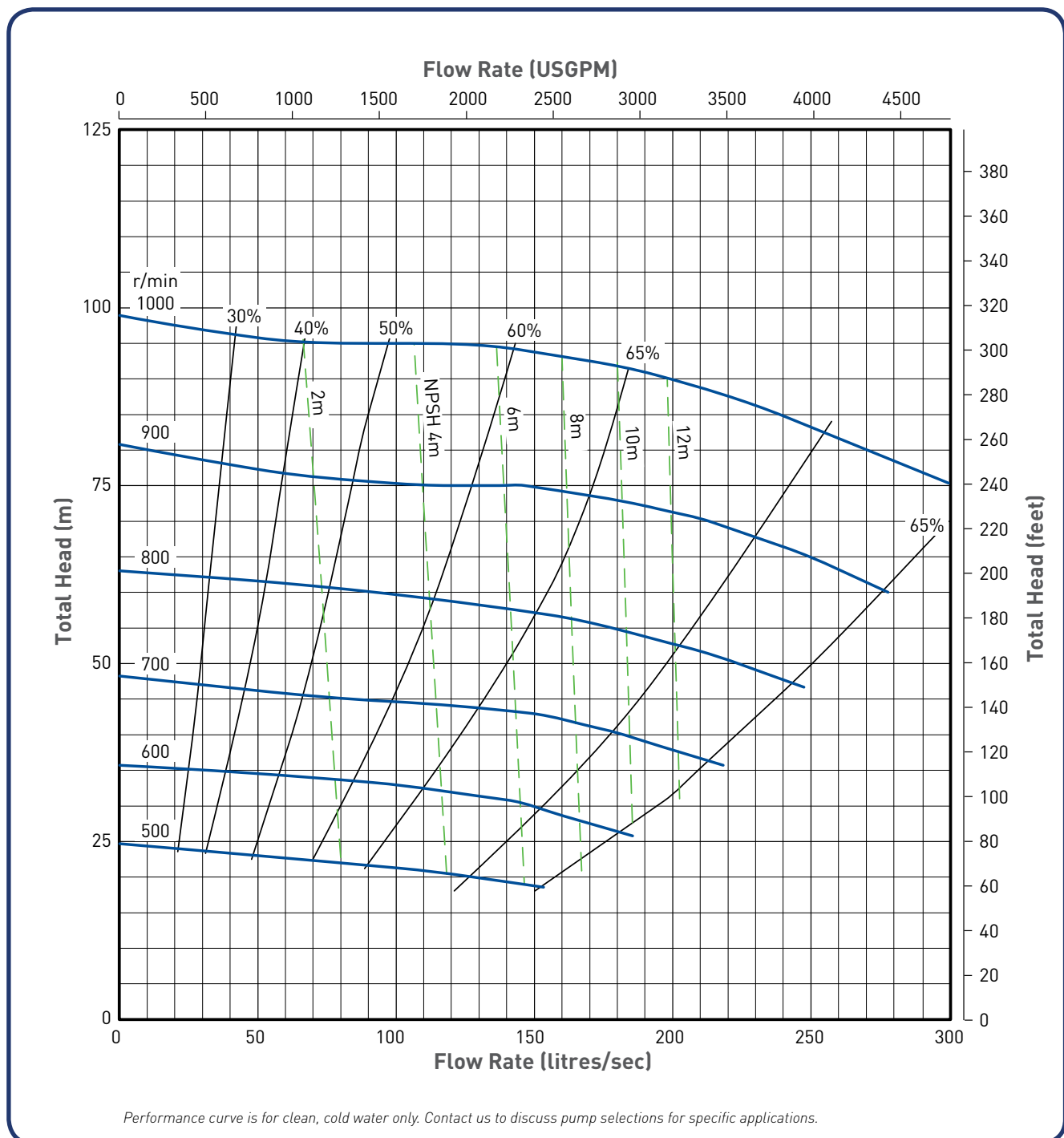

MAH 10x8

METAL LINER AND IMPELLER

PUMP SPECIFICATIONS

Outlet/ Inlet (mm)	Bearing Frame	Max Power (kW)	Max Particle Size (mm)	Impeller	No. of Vanes	Impeller Material	Impeller/ Vane Dia. (mm)	Wear Liner Material
250/200	F	260	76	FAM8147 G8147	5	27% Chrome White Iron	686	27% Chrome White Iron
	ST	560						
	X (743)	710						

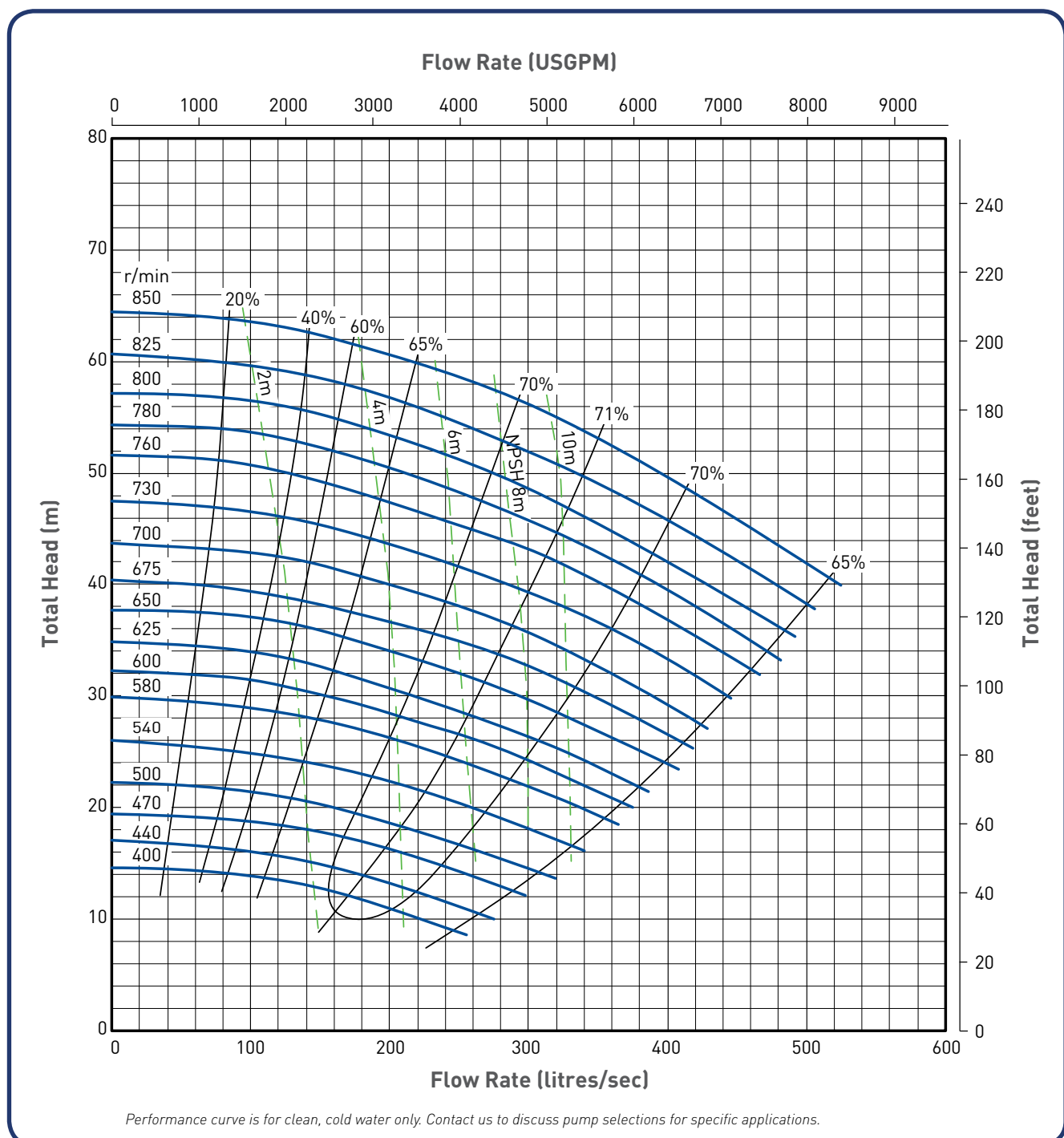

MAH 10x8

RUBBER LINER AND IMPELLER

PUMP SPECIFICATIONS

Outlet/ Inlet (mm)	Bearing Frame	Max Power (kW)	Max Particle Size (mm)	Impeller	No. of Vanes	Impeller Material	Impeller/ Vane Dia. (mm)	Wear Liner Material
250/200	F	260	76	FAM8147	5	Rubber Lined High Tensile Steel	686	Rubber
	ST	560						

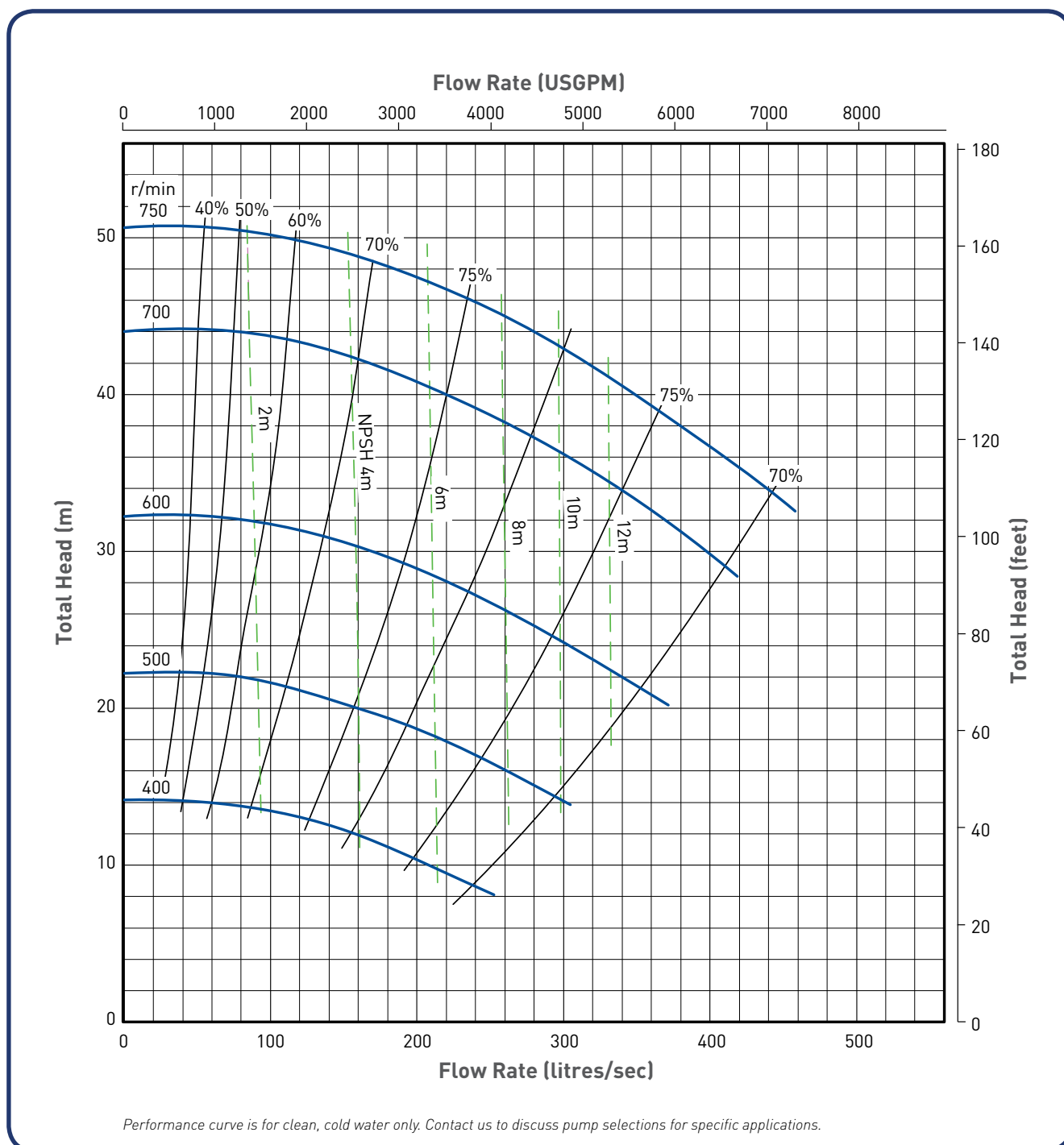

Performance curve is for clean, cold water only. Contact us to discuss pump selections for specific applications.

MAH 12x10

METAL LINER AND IMPELLER

PUMP SPECIFICATIONS

Outlet/ Inlet (mm)	Bearing Frame	Max Power (kW)	Max Particle Size (mm)	Impeller	No. of Vanes	Impeller Material	Impeller/ Vane Dia. (mm)	Wear Liner Material
300/250	ST	560	86	FAM10147 G10147	5	27% Chrome White Iron	762	27% Chrome White Iron
	X (743)	560						

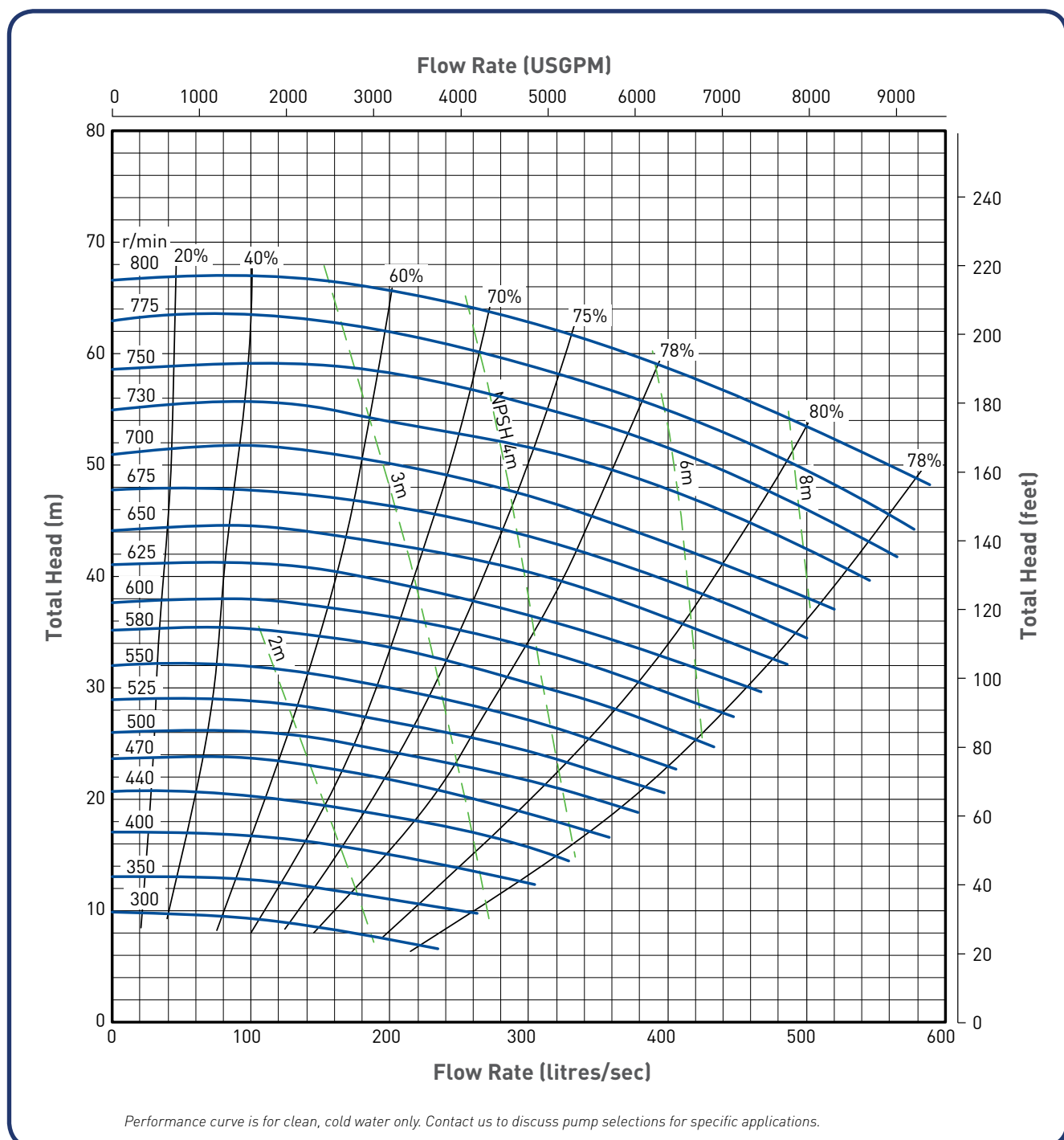

MAH 12x10

RUBBER LINER AND IMPELLER

PUMP SPECIFICATIONS

Outlet/ Inlet (mm)	Bearing Frame	Max Power (kW)	Max Particle Size (mm)	Impeller	No. of Vanes	Impeller Material	Impeller/ Vane Dia. (mm)	Wear Liner Material
300/250	ST	560	86	G10147	5	Rubber Lined High Tensile Steel	762	Rubber
	G	600						

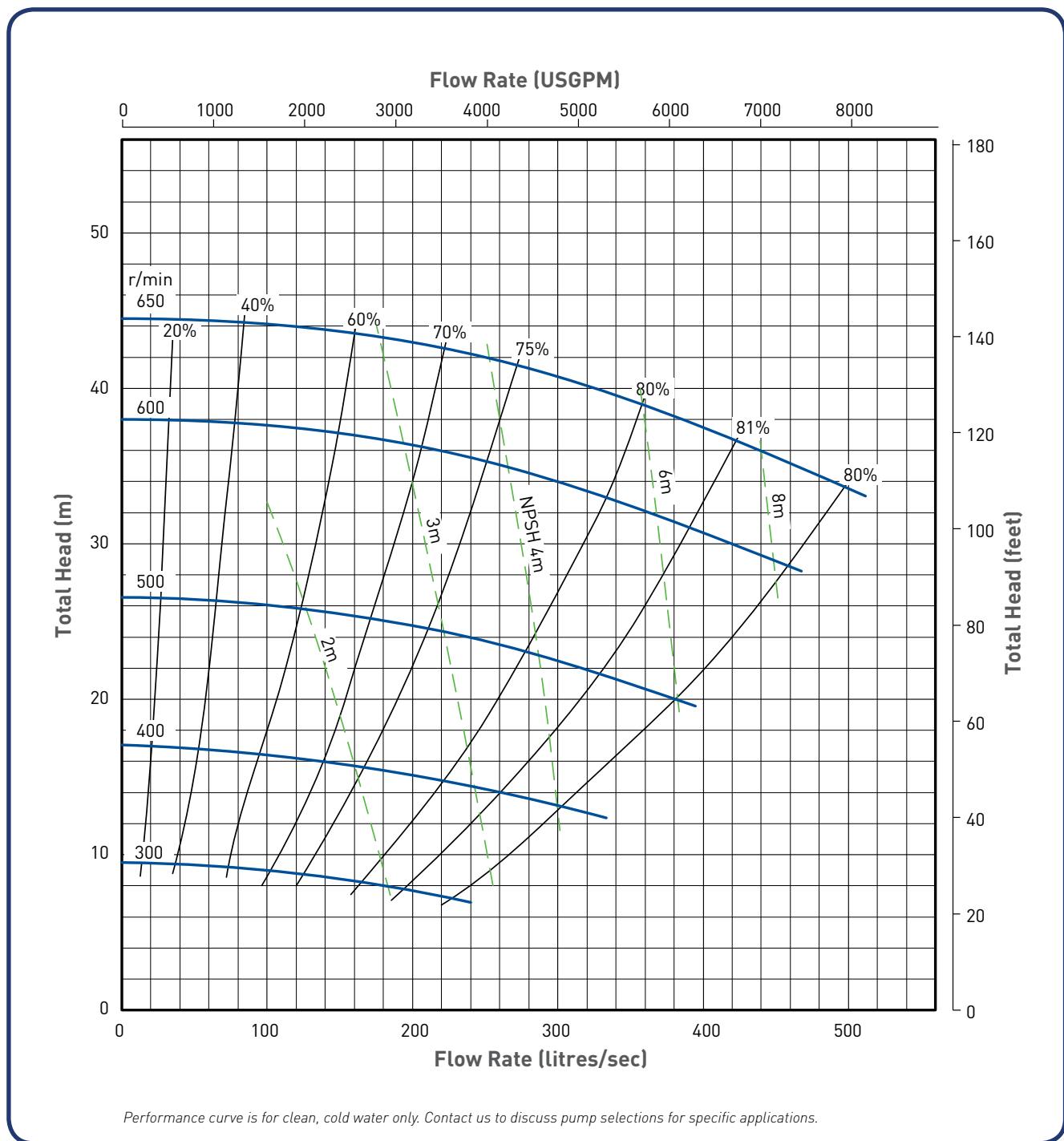

MAH 14x12

METAL LINER AND IMPELLER

PUMP SPECIFICATIONS

Outlet/ Inlet (mm)	Bearing Frame	Max Power (kW)	Max Particle Size (mm)	Impeller	No. of Vanes	Impeller Material	Impeller/ Vane Dia. (mm)	Wear Liner Material
350/300	ST	560	90	FAM12147 G12147	5	27% Chrome White Iron	965	27% Chrome White Iron
	T	1200						

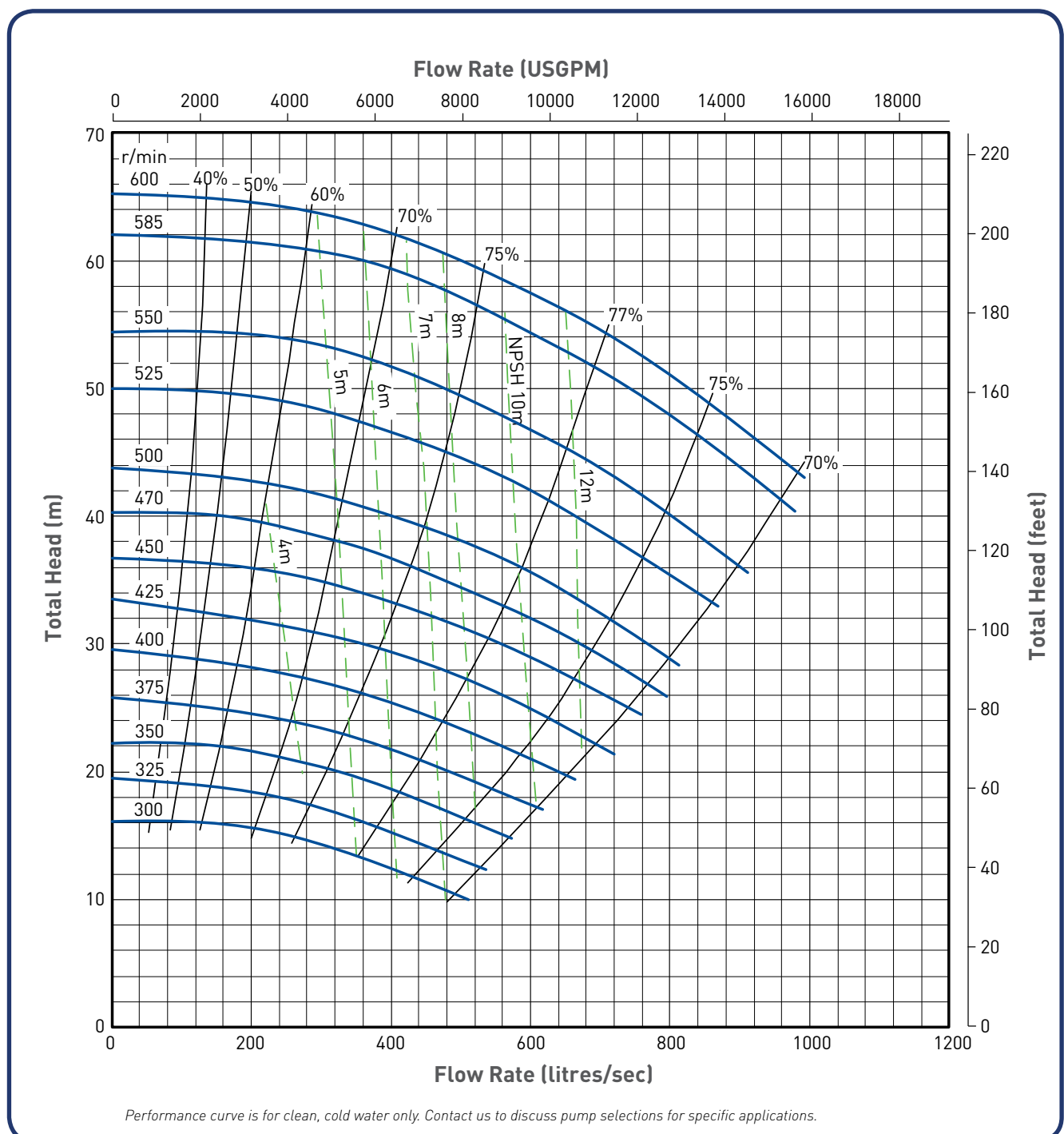

MAH 14x12

RUBBER LINER AND IMPELLER

PUMP SPECIFICATIONS

Outlet/ Inlet (mm)	Bearing Frame	Max Power (kW)	Max Particle Size (mm)	Impeller	No. of Vanes	Impeller Material	Impeller/ Vane Dia. (mm)	Wear Liner Material
350/300	ST	560	104	G12147	5	Rubber Lined High Tensile Steel	965	Rubber
	G	600						

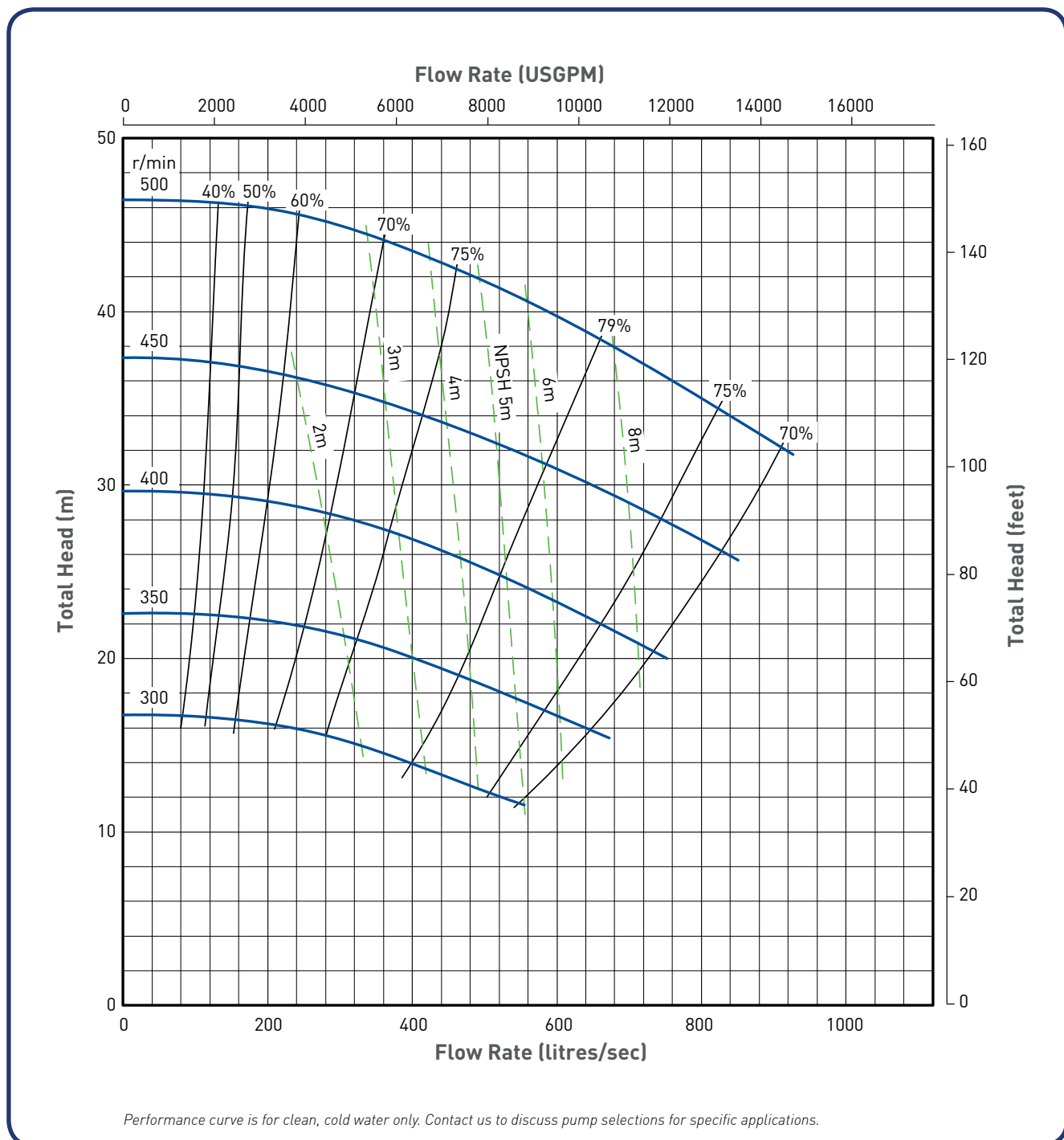

DIMENSIONS

GENERAL ARRANGEMENT DRAWING

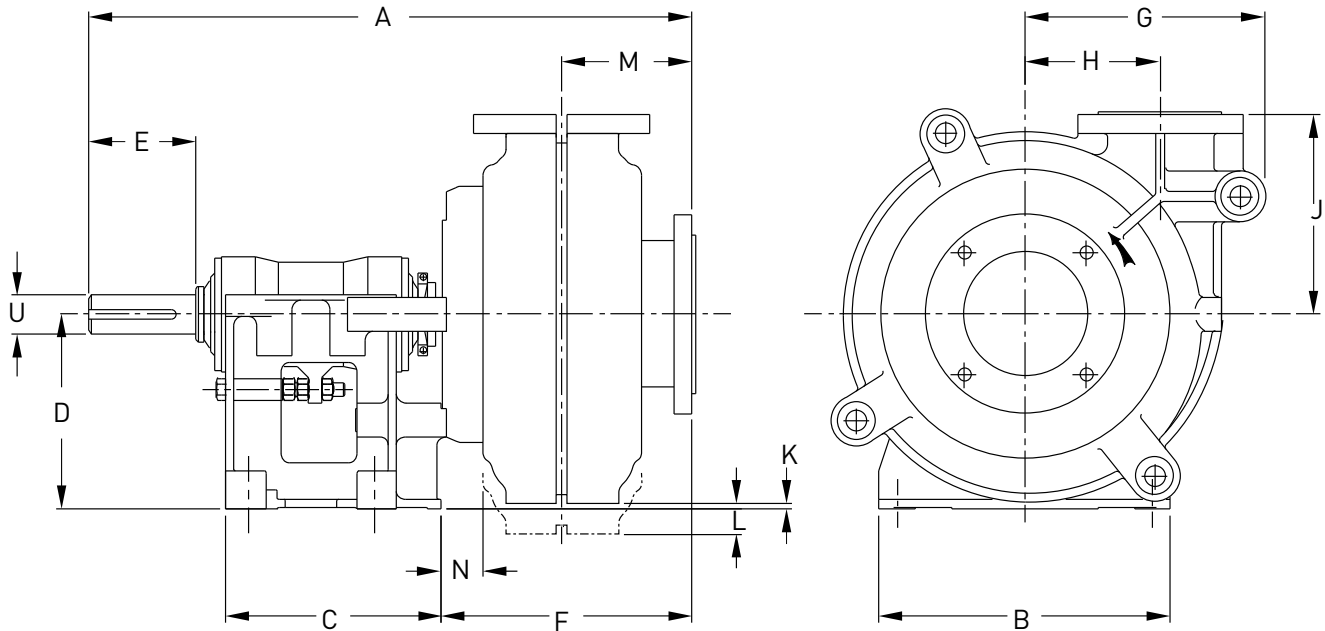

Note: Drawing is indicative only and does not accurately represent how pumps of all sizes will appear.

Model	Dimensions (mm)															Weight (kg)	
	A	B	C	D	Key	E	F	G	H	J	K	L	M	N	U	Metal	Rubber
1.5x1 B	583	295	248	197	8x7	79	206	181	98	171	46	-	106	19	28	88	77
1.5x1 C - HH	759	406	311	254	12x8	121	306	270	194	254	-	11	121	66	42	318	-
2x1.5 B	592	295	248	197	8x7	79	217	203	114	184	33	-	114	22	28	156	118
3x2 C	768	406	311	254	12x8	121	280	238	138	210	71	-	151	40	42	197	154
3x2 D - HH	986	492	364	330	18x11	164	389	384	254	368	-	51	203	83	65	750	-
4x3 C	843	406	311	254	12x8	121	353	292	149	262	24	-	187	54	42	249	236
4x3 D	943	492	364	330	18x11	164	353	292	149	262	100	-	187	52	65	318	290
4x3 E - HH	1240	622	448	457	22x14	222	492	492	330	432	-	12	248	79	80	1250	-
6x4 D	1021	492	364	330	18x11	164	424	406	229	338	11	-	219	65	65	669	454
6x4 E	1178	622	448	457	22x14	222	433	406	229	338	138	-	219	75	80	885	635
6x4 F - HH	1556	857	634	610	28x16	279	585	616	413	546	-	134	305	75	100	3420	-
8x6 E	1302	622	448	457	22x14	222	557	551	318	460	-	62	292	82	80	1497	982
8x6 F	1507	857	635	610	28x16	279	539	551	318	460	90	-	292	65	100	1814	1390
8x6 T - HH	2275	1150	1040	650	36x20	350	852	835	584	813	-	160	394	-	150	6900	-
10x8 F	1646	991	705	610	28x16	279	683	673	419	635	-	12	333	134	100	3193	2581
10x8 ST	1748	1150	780	650	32x18	280	692	673	419	635	27	-	333	143	120	3742	3130
12x10 F	1721	991	705	610	28x16	279	753	756	464	673	-	104	381	108	100	3760	2808
12x10 ST	1816	1150	780	650	32x18	280	762	755	464	673	-	65	381	117	120	4309	3357
14x12 F	1772	991	705	610	28x16	279	803	937	629	832	-	263	406	105	100	5847	4123
14x12 ST	1873	1150	780	650	32x18	280	812	937	629	832	-	224	406	114	120	6396	4672
16x14 TU	2320	1460	1050	900	36x20	350	953	1048	660	889	-	84	451	167	150	9979	-
20x18 TU	2475	1460	1050	900	36x20	350	1100	1420	940	1230	-	420	480	210	150	18864	15921

MATERIALS

METAL LINED PUMPS

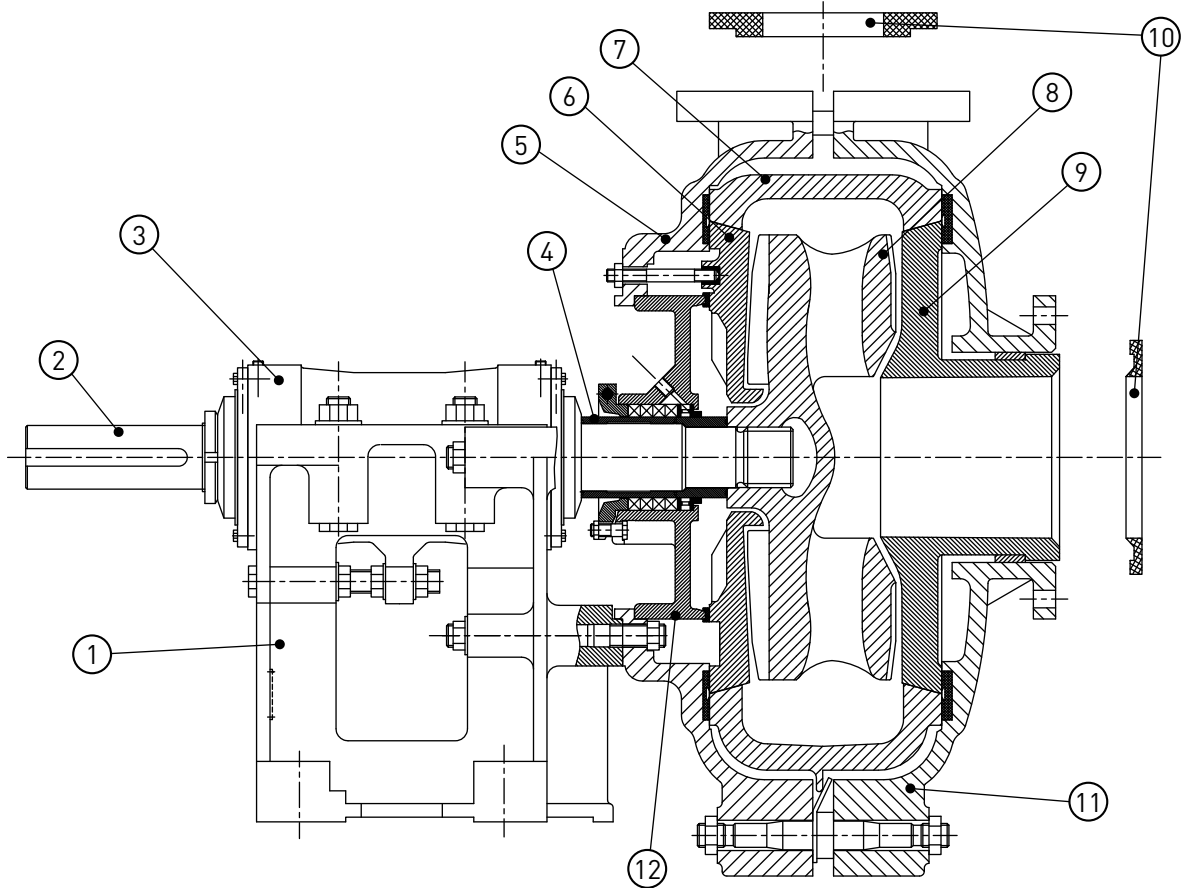

No.	Part Description	Material Specification
1	Base	Cast Iron
2	Shaft	4140 High Tensile Steel*
3	Bearing Assembly	Timkin (Cast Iron Body)
4	Shaft Sleeve	420 Stainless Steel
5	Pump Casing	Cast Iron
6	Frame Plate Liner	27% Chrome White Iron
7	Volute Liner	27% Chrome White Iron
8	Impeller	27% Chrome White Iron
9	Throat Bush	27% Chrome White Iron
10	Joint Rings	Rubber
11	Cover Plate	Cast Iron
12	Stuffing Box	Cast Iron
13	Expeller	27% Chrome White Iron
14	Expeller Ring	Natural Rubber
	Bolts	Zinc Plated Steel
	O-rings	Nitrile Rubber
	Seals	Rubber

* Other shaft material options are available.

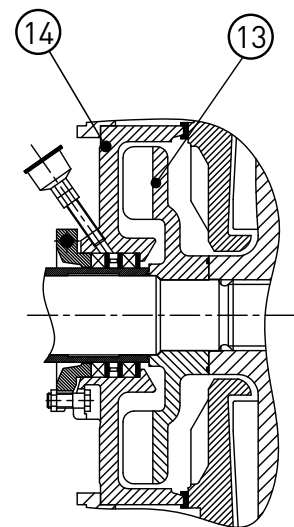

METAL EXPELLER

MATERIALS

RUBBER LINED PUMPS

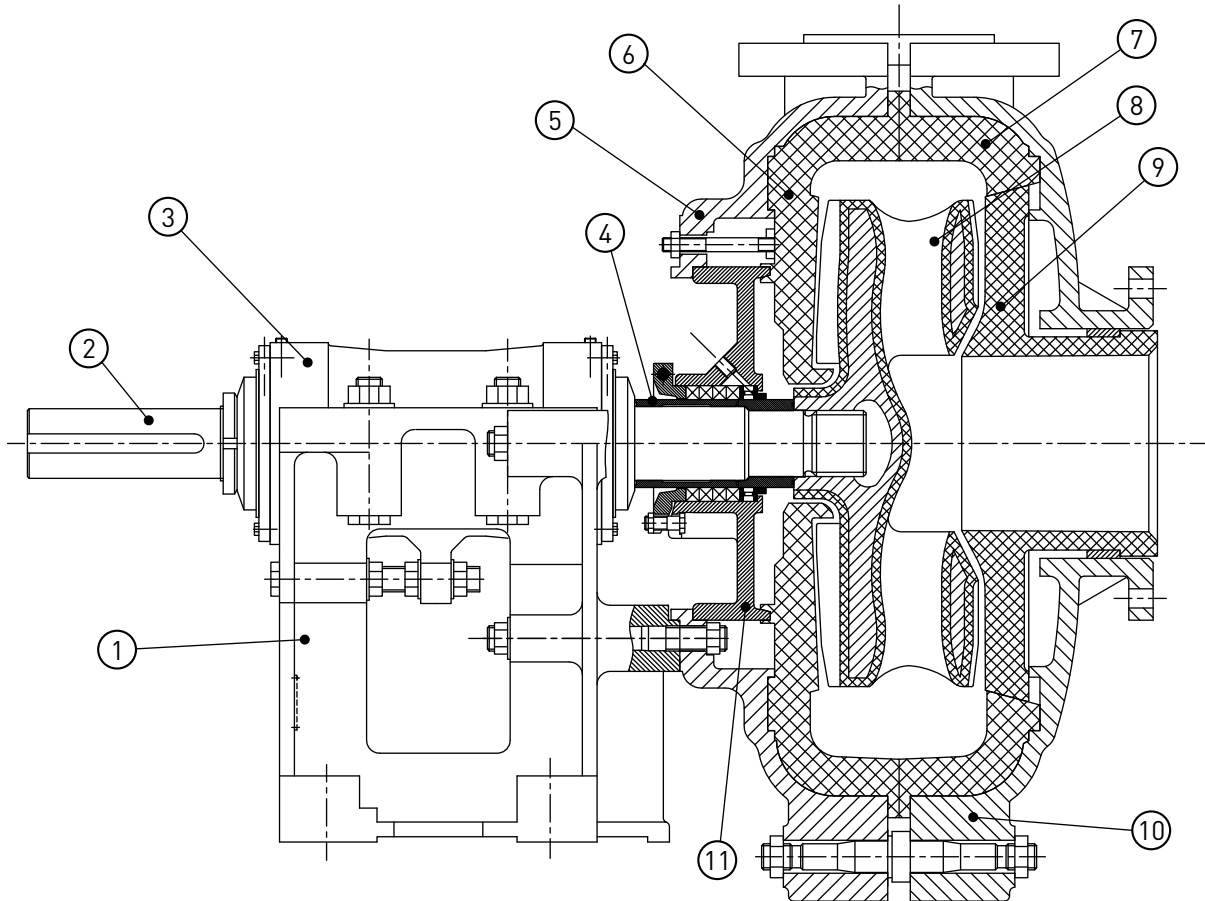

No.	Part Description	Material Specification
1	Base	Cast Iron
2	Shaft	4140 High Tensile Steel*
3	Bearing Assembly	Timkin (Cast Iron Body)
4	Shaft Sleeve	420 Stainless Steel
5	Pump Casing	Cast Iron
6	Frame Plate Liner Insert	Rubber
7	Cover Plate Liner	Rubber
8	Impeller	Rubber Coated High Tensile Steel
9	Throat Bush	Rubber
10	Cover Plate	Cast Iron
11	Stuffing Box	Cast Iron
12	Expeller	27% Chrome White Iron
13	Expeller Ring	Natural Rubber
	Bolts	Zinc Plated Steel
	O-rings	Nitrile Rubber
	Seals	Rubber

* Other shaft material options are available.

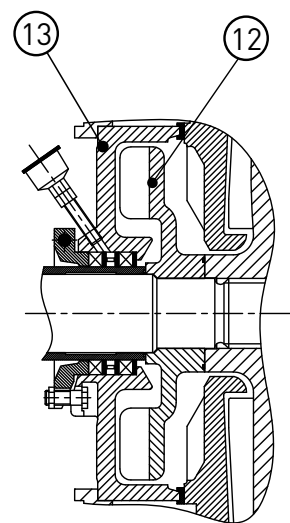

METAL EXPELLER
(RUBBER EXPELLER AVAILABLE)