

Surgical Drapes Surgical Packs



Ningbo PINMED Instruments Co., Ltd.

Add: 18F, No.1 Building, Wante Business Centre,
Hi-Tech Zone, 315042 Ningbo, China
Tel : 0086-574-87919045 Fax : 0086-574-87739075
E-mail : sales@china-pinmed.com
Http ://www.china-pinmed.com



The **11**th
Book

Ningbo PINMED Instruments Co., Ltd.



Company Profile

Pinmed is located in the beautiful sea port city ,Ningbo. and we are focus on the top quality of medical products to introduce to global customer. as we have very advanced technical department to do products design, new innovation and improve our quality day by day. the engineer team with good education background in USA or in Germany. and our production line has cleaning room to sure the products is very clear. also we have strictly quality control system. our products have CE approved and FDA approved.

We hope we can bring you the best quality in China and bring the customer more safety and more reliable products.

Quality is everything, we don't do cheaper quality, we just do the best quality.

Ningbo Pinmed Instruments Co.,Ltd.



Protective Products

Surgical Drapes

Code	Length CM	PE width CM	Reinforcement Width CM	PE GSM	Reinforcement GSM	Reinforcement Material
PM3111	100	140	60	50	30	Absorbent PSB
PM3112	140	140	60	50	30	Absorbent PSB
PM3104	190	140	60	50	30	Absorbent PSB
PM3113	210	140	60	50	30	Absorbent PSB
PM3114	190	150	75	50	30	Absorbent PSB
PM3106	200	150	76	50	30	Absorbent PSB
PM3115	229	150	75	50	30	Absorbent PSB
PM3116	240	150	75	50	30	Absorbent PSB
PM3117	112	112	60	50	30	Absorbent PSB
PM3120	152	112	112	30	20	Absorbent PSB
PM3101	190	112	60	50	30	Absorbent PSB
PM3118	195	112	60	50	30	Absorbent PSB
PM3102	229	112	60	50	30	Absorbent PSB
PM3119	228	195	100	75	30	Absorbent PSB
PM3103	228	127	76	50	30	Absorbent PSB

All Back Table Covers are latexfree

Code	width CM	PE Length CM	Reinforcement Width CM	Reinforcement Length CM	PE GSM	Reinforcement GSM	Reinforcement Material
PM3201	58	137	48	60	50	30	Absorbent PSB
PM3202	75	145	60	75	50	30	Absorbent PSB
PM3207	80	145	60	75	50	30	Absorbent PSB
PM3208	75	145	60	75	55	30	Absorbent PSB
PM3209	80	145	60	75	55	30	Absorbent PSB

All Mayo Stand Covers are latexfree

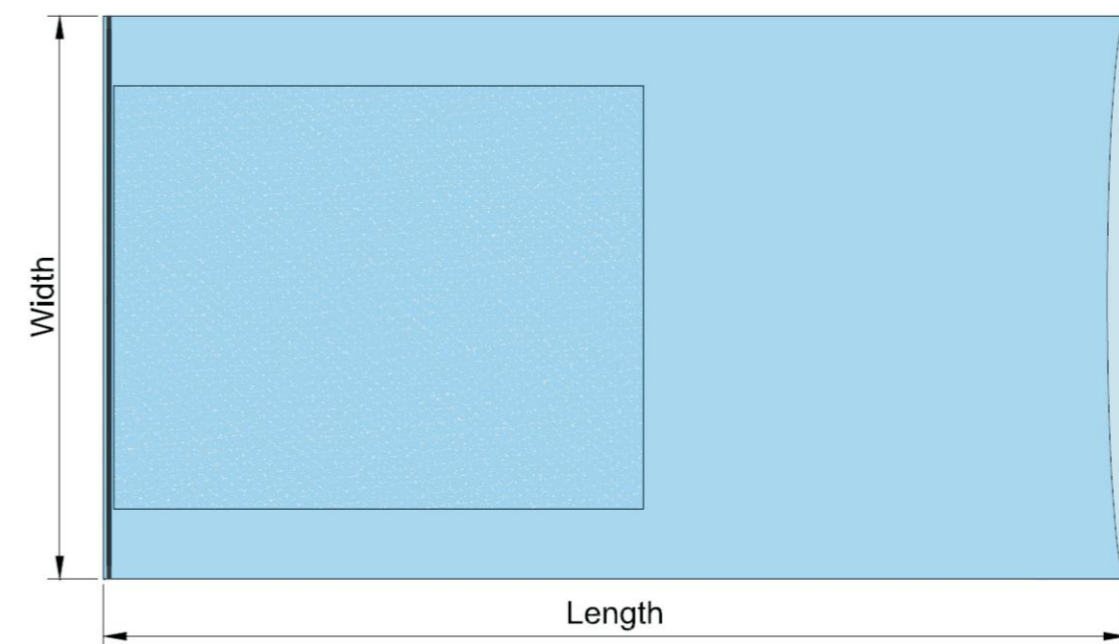
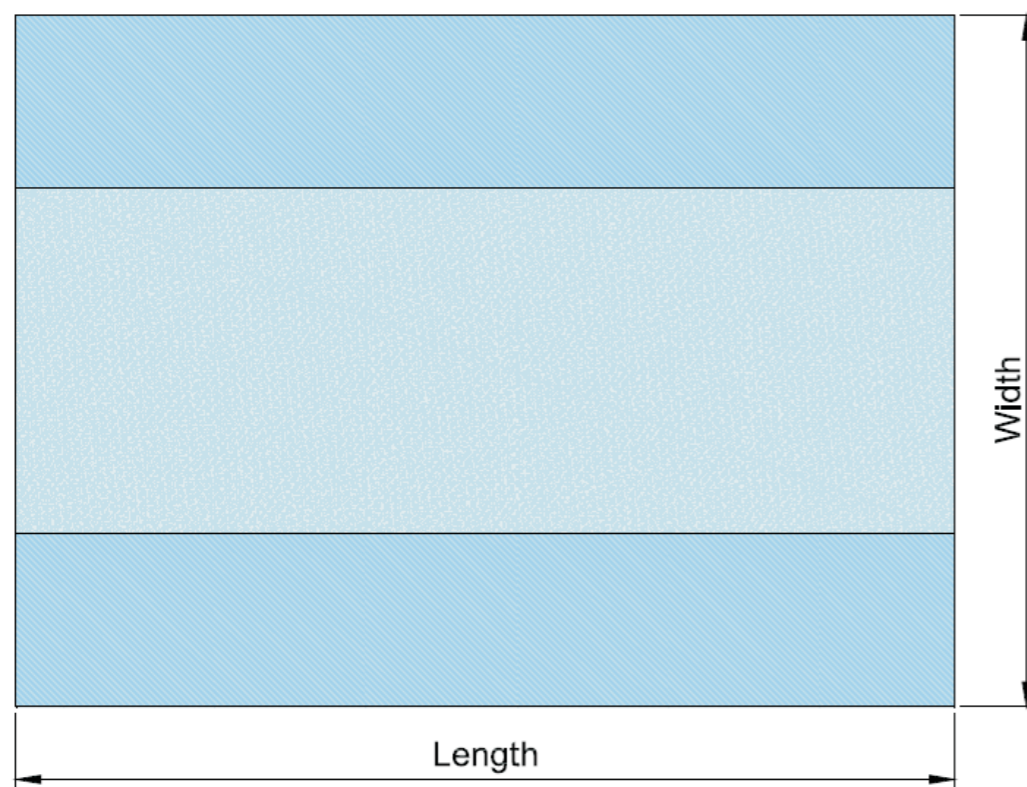

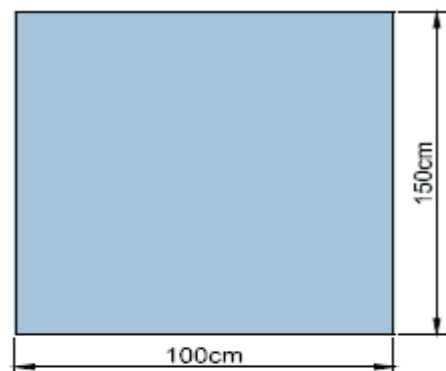

PM2006
Drape (SMS)
- Fan Folded

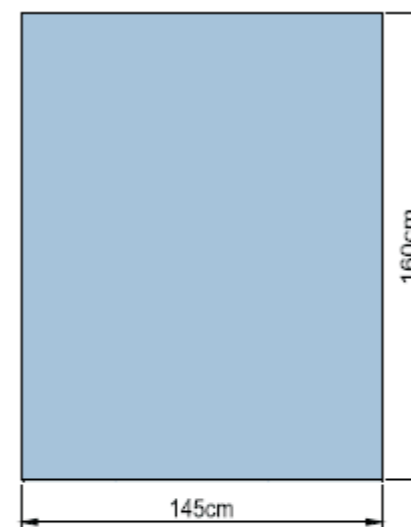

PM6502
Three Quater Drape (SMS)
- Fan Folded

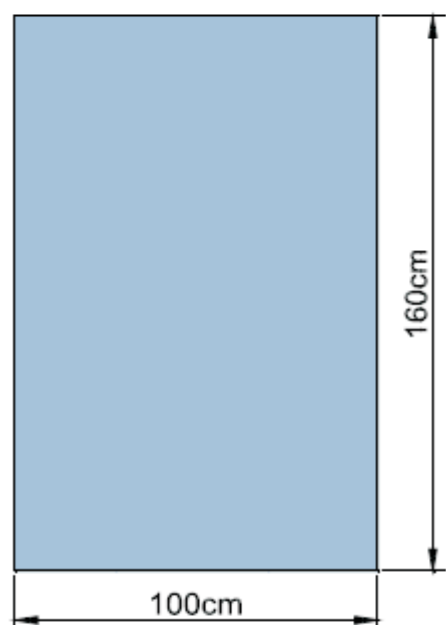

PM2002
Medium Drape (SMS)
- Fan Folded

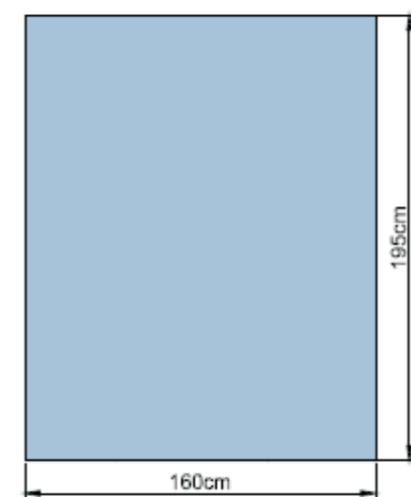

PM2005
Large Drape (SMS)
- Fan Folded

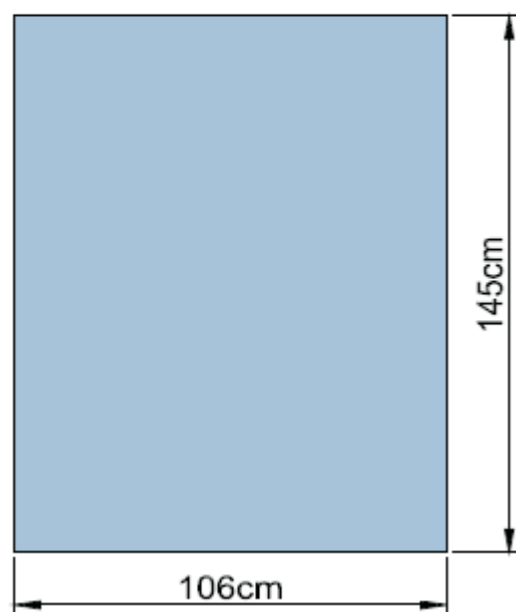

PM6501
Half Drape (SMS)
- Fan Folded

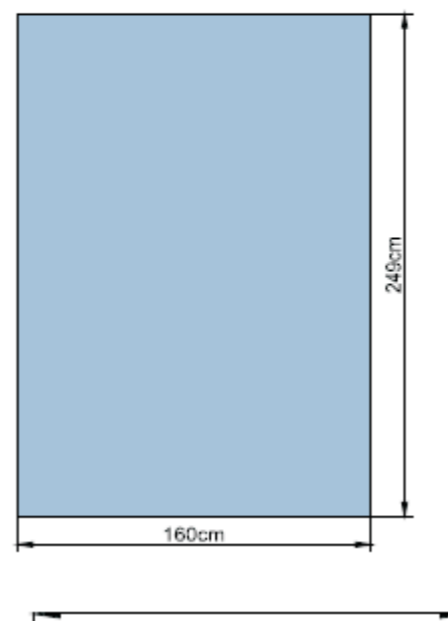

PM2004
Extra-large Drape (SMS)
- Fan Folded

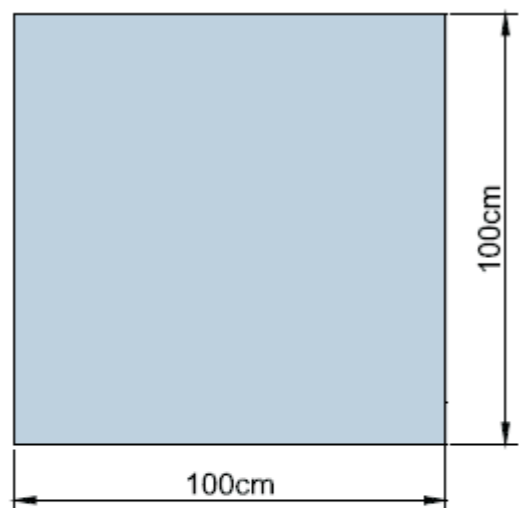

PM6514
Drape (SMS)
- Fan Folded

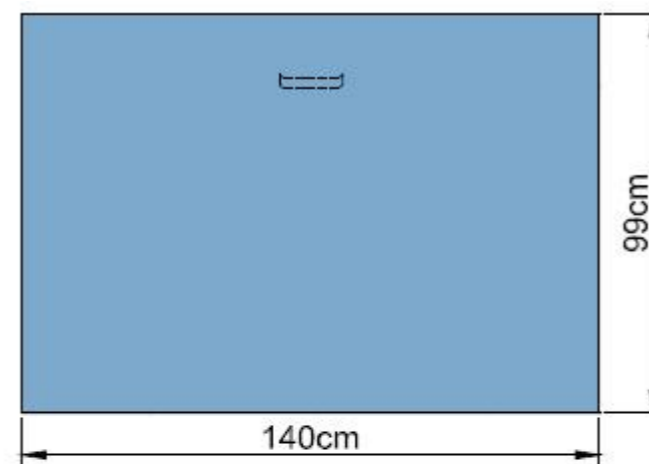

PM6503
Drape 140x99cm
- Adhesive

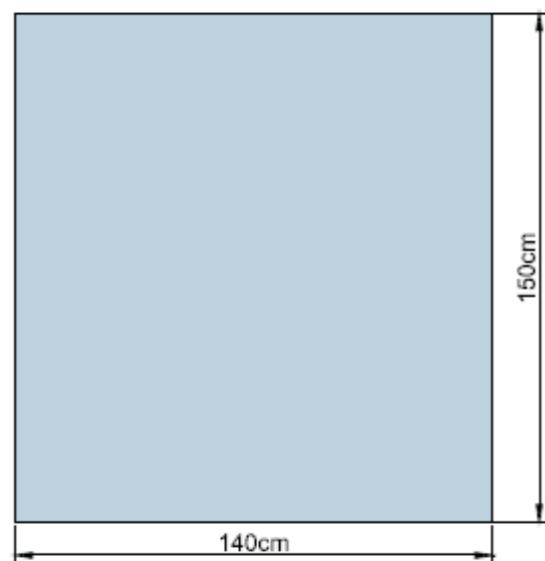

PM6515
Drape (SMS)
- Fan Folded

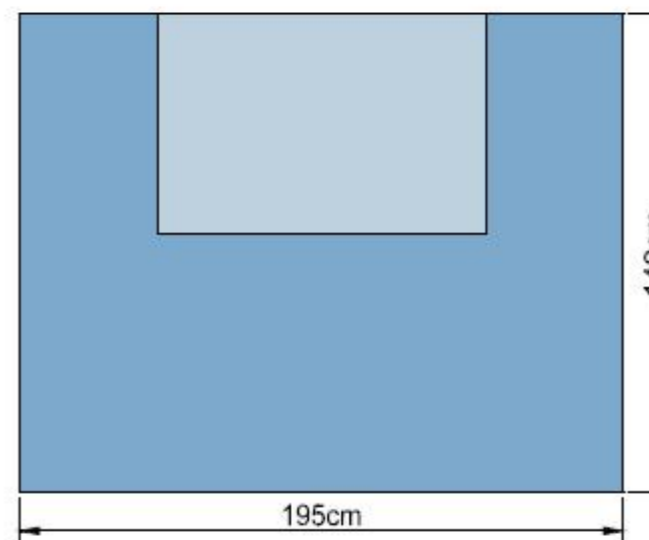

PM2009
Three Quarter Drape (SMS)
- 65x106cm Absorbent
Reinforcement

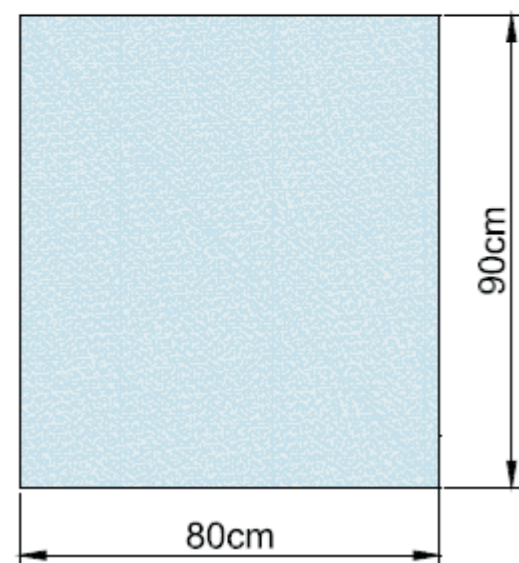

PM6516
Baby Towel
80x90cm

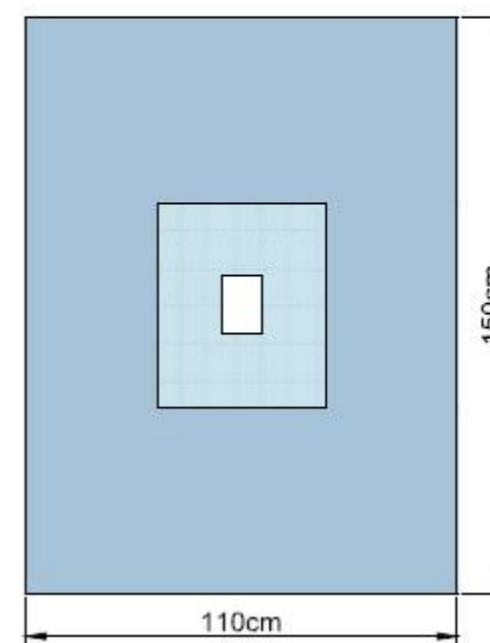

PM2010
Drape (SMS)
- Absorbent Reinforcement
43x53cm
- Fenestration (10x15cm)

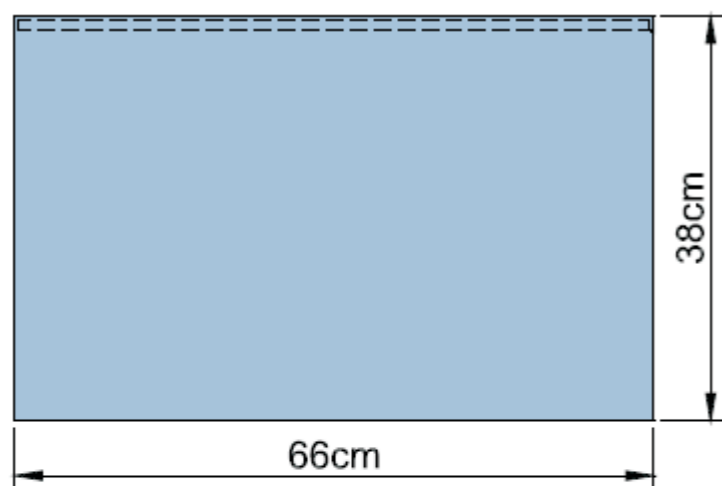

PM6571B
Towel Drape (Bi-Lam)
- 38x66cm
- Adhesive

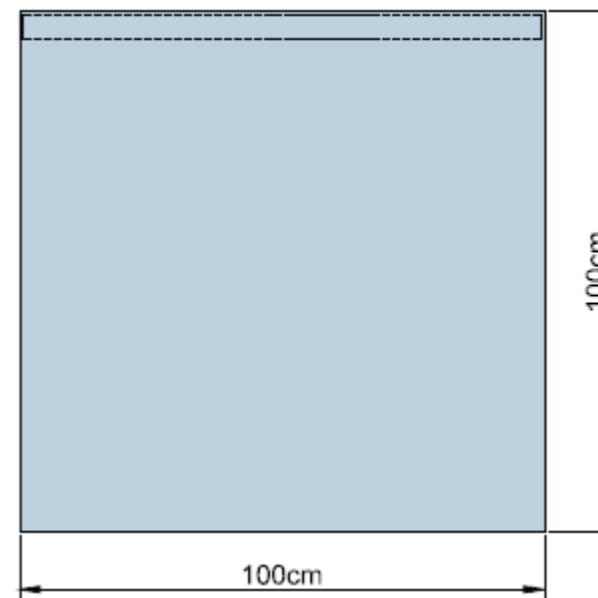

PM6307
Side Drape
- 100x100cm
- Adhesive

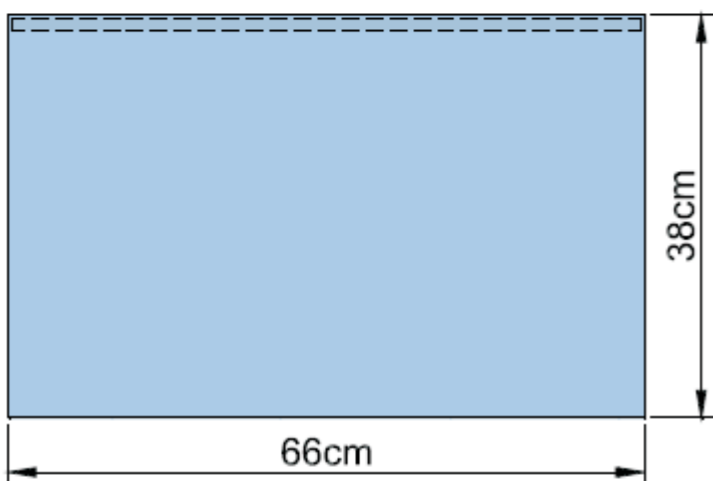

PM6571S
Towel Drape (SMS)
- 38x66cm
- Adhesive

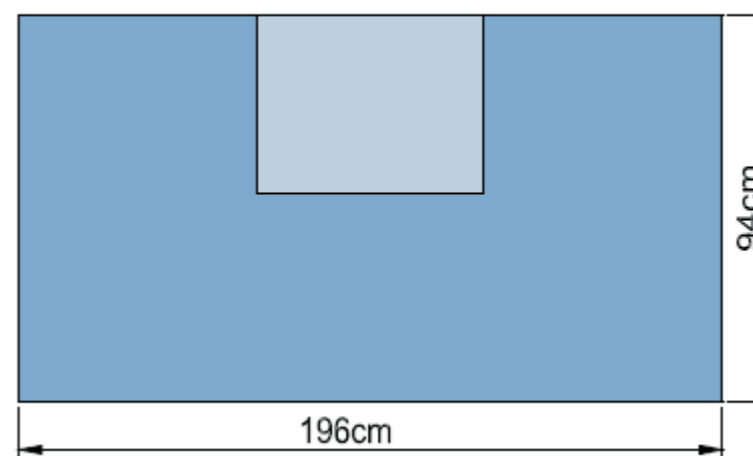

PM6301
Side Drape 196x94cm
- 43x64cm
Absorbent Reinforcement

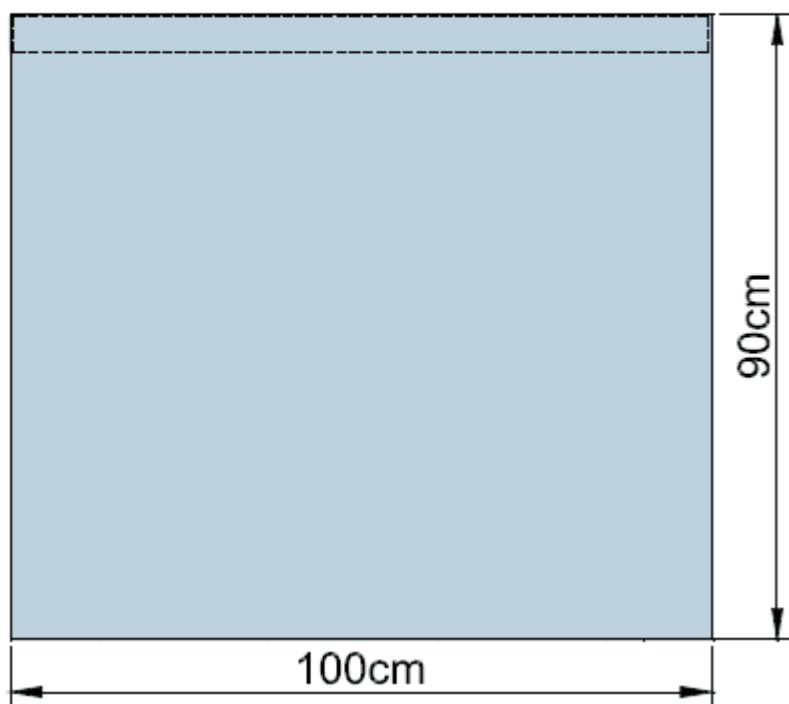

PM6302
Side Drape (Tri-Lam)
- 100x90cm
- Adhesive

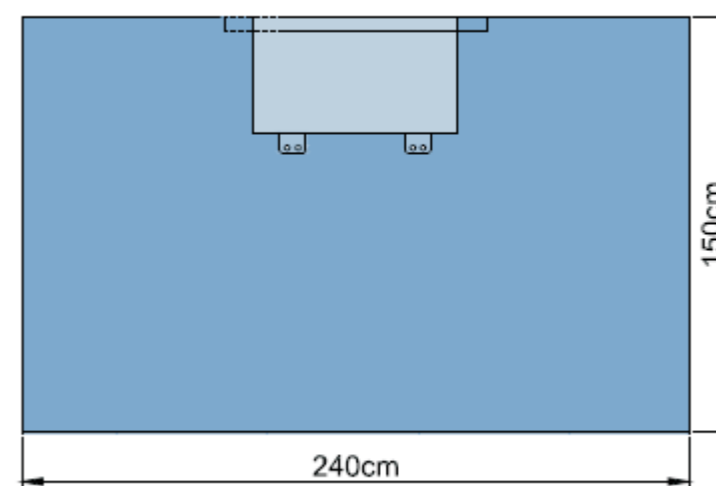

PM4034
Top Drape
- 42x74cm Absorbent
Reinforcement

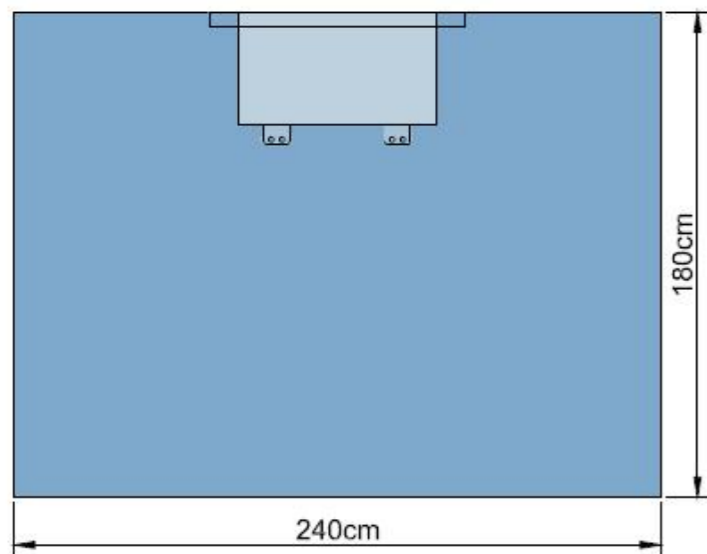

PM6105
 Top Drape
 - 42x74cm Absorbent Reinforcement

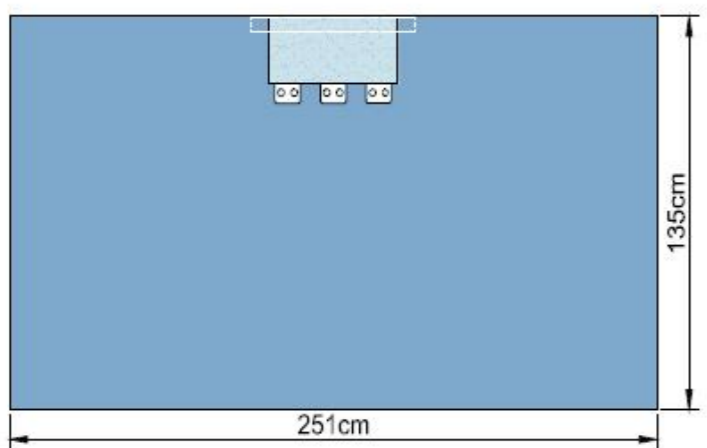

PM6103
 Top Drape
 - 23x50cm Absorbent Reinforcement
 - Instrument Pad
 - Tube Holders

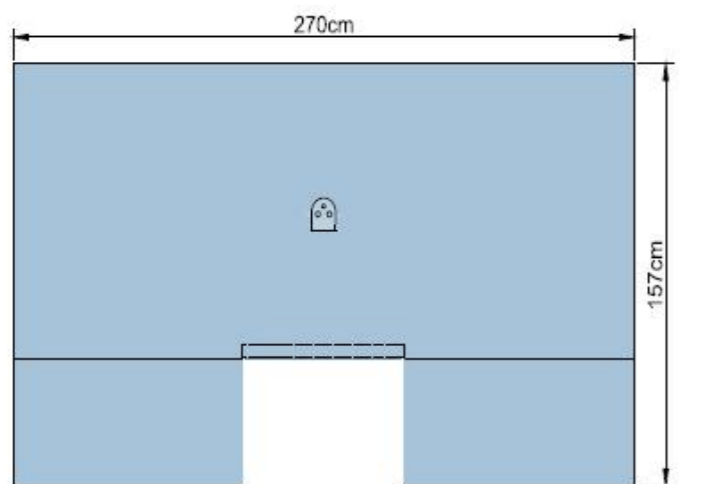

PM6102
 Top Drape 157x270
 - Tube Holders

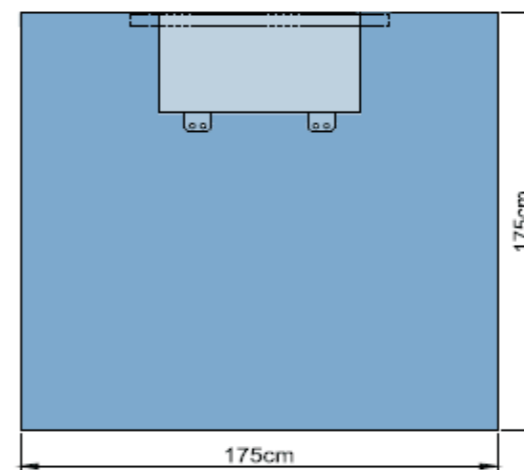

PM4035
 Bottom Drape
 - 4 x74cm Absorbent Reinforcement
 - Tube Holders

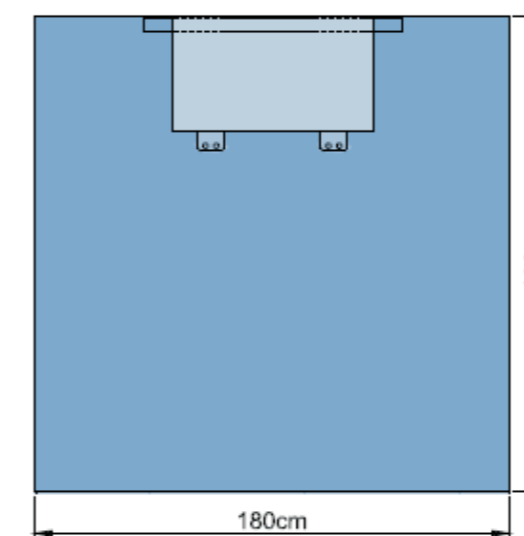

PM6203
 Bottom Drape
 - 42x74cm Absorbent Reinforcement
 - Tube Holders

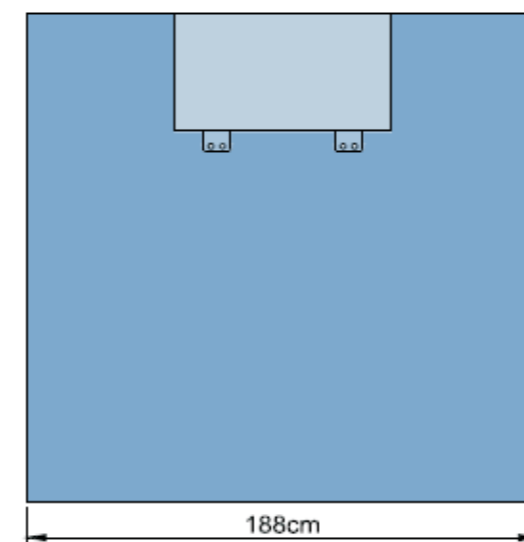

PM6202
 Bottom Drape
 - 38x64cm Absorbent Reinforcement
 - Tube Holders

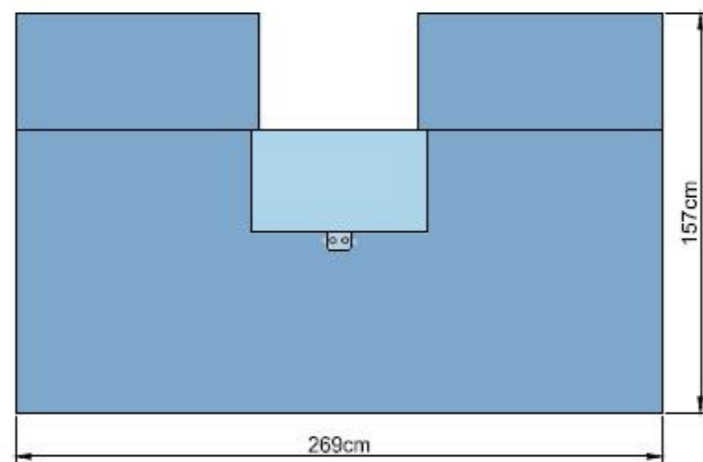

PM4055
 Bar Sheet (Tri-Lam)
 - Absorbent Reinforcement
 74x40cm
 - Tube Holders
 - Adhesive

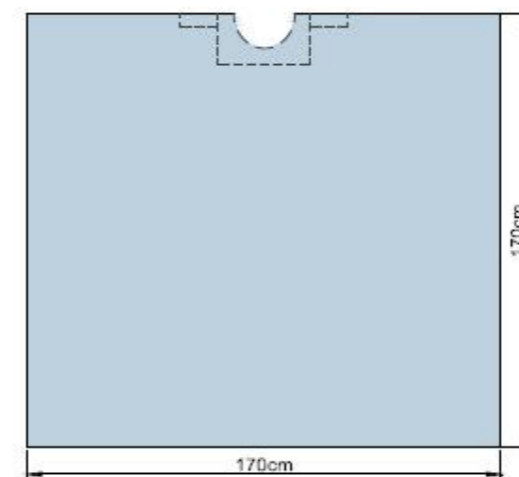

PM6303
 Omega Drape 170x170cm
 - Adhesive

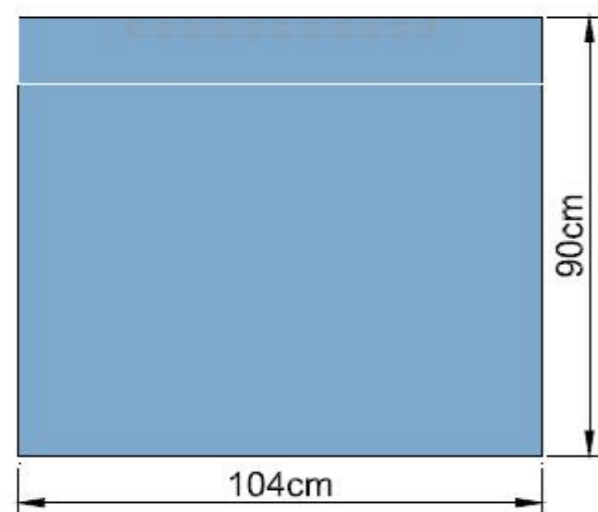

PM4060
 Bar Sheet (Tri-Lam)
 104x90cm
 - 14cm CUFF

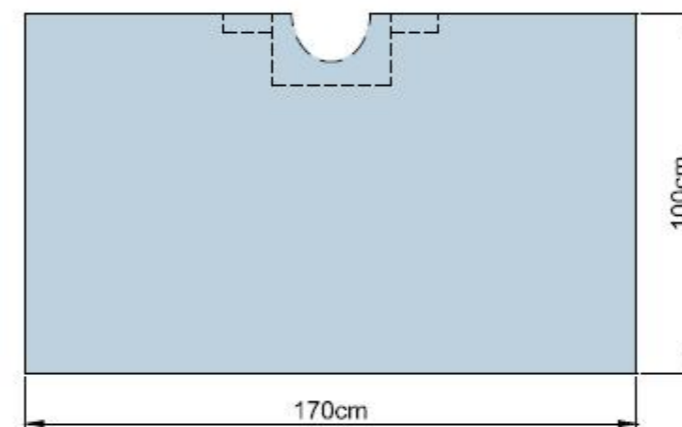

PM6306
 Omega Drape 170x100cm
 - Adhesive

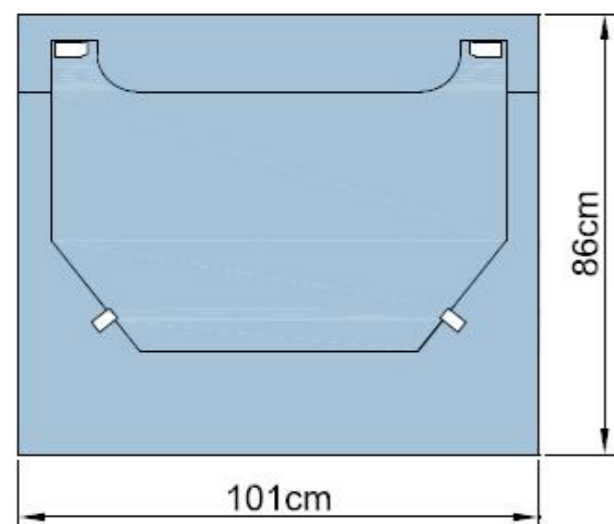

PM7401
 Head/Bar Drape (Tri-Lam)
 101x86cm

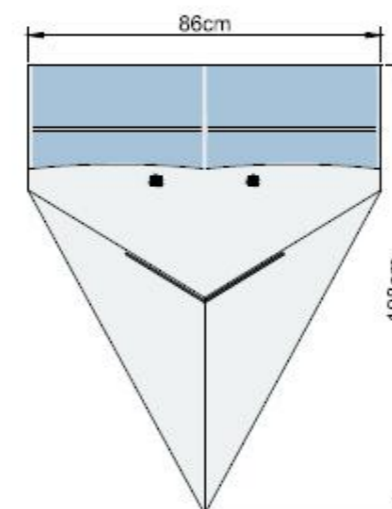

PM6904
 Poly Under Buttocks Drape
 - Absorbent Reinforcement
 86x108cm
 - Absorbent Reinforcement
 - Fluid Control Pouch

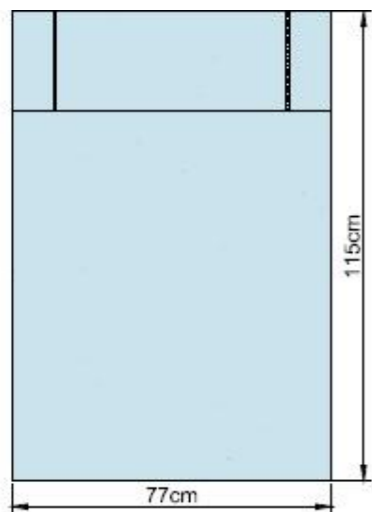

PM6901
Under Buttocks Drape
77x115cm

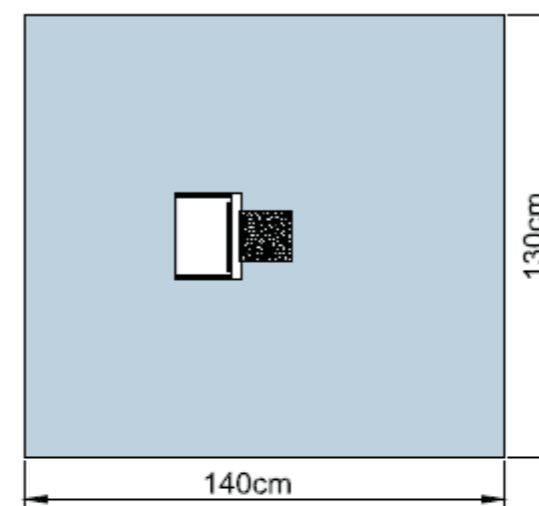

PM7101
Eye Drape (SMS)
- 130x140cm
- Pouch (25x30cm)
- Incise Tape

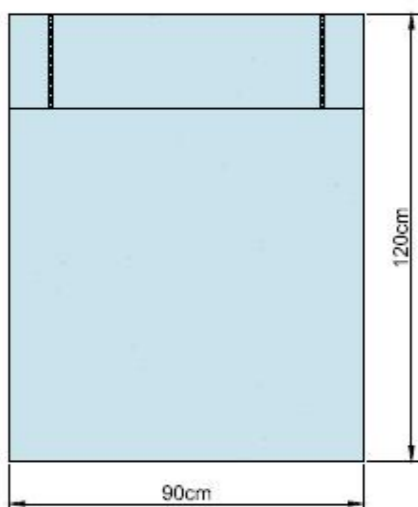

PM6905
Under Buttocks Drape
90x120cm

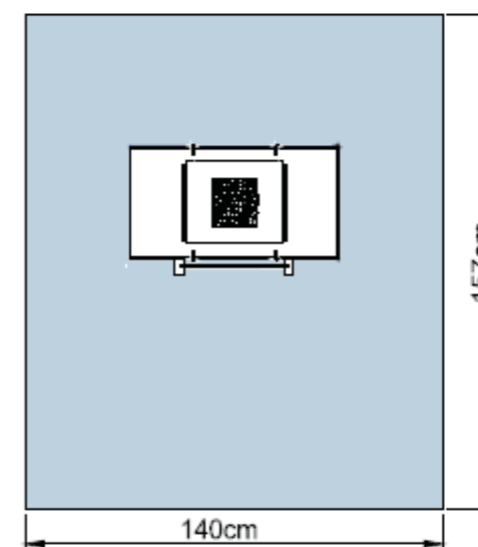

PM7102
Eye Drape (SMS)
- 140x157cm
- Pouch (70x36cm)
- Incise Tape

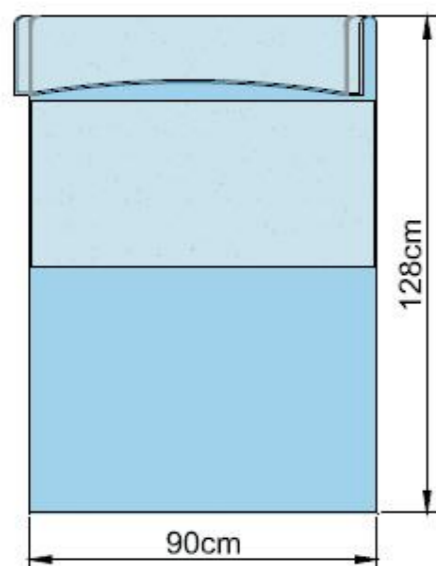

PM6902
Under Buttocks Drape
- Absorbent Reinforcement
38x91cm

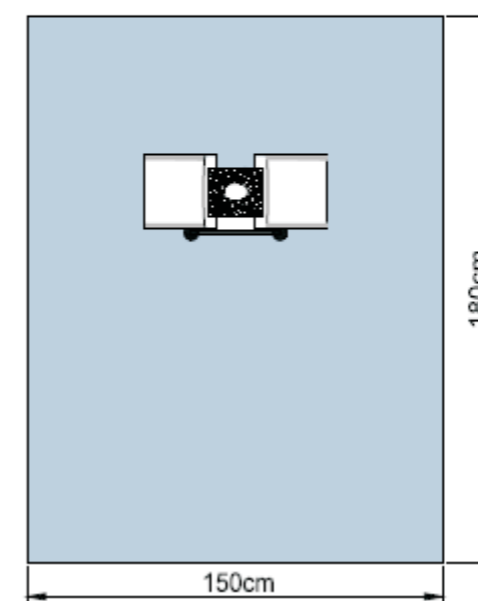

PM7103
Eye Drape (SMS)
- 150x180cm
- 2 Pouch (24x26cm)
- Incise Tape

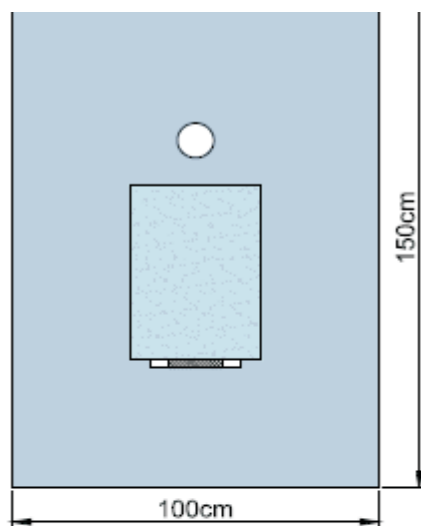

PM7151
 Dental surgery drape
 - 10x150cm
 - Absorbent Reinforcement
 36x50cm
 - Hole 10cm
 - Velcro Tabs

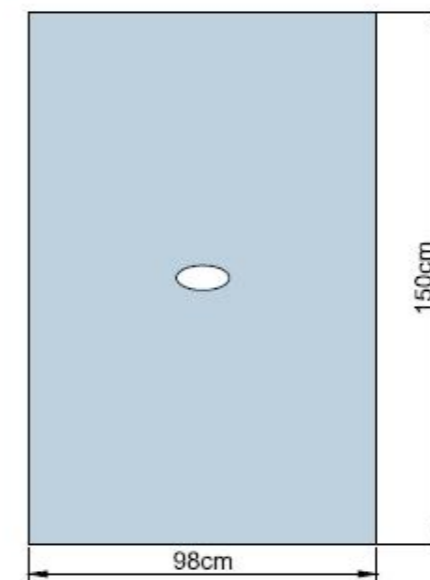

PM6574
 Fen drape 98x150cm
 - Oval 15x7cm

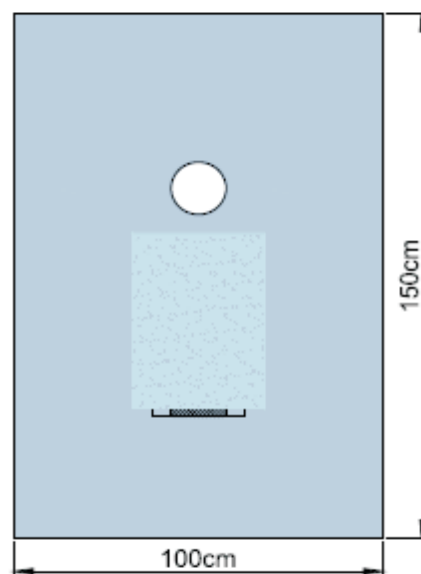

PM7152
 Dental surgery drape
 - 10x150cm
 - Absorbent Reinforcement
 36x50cm
 - Hole 15cm
 - Velcro Tabs

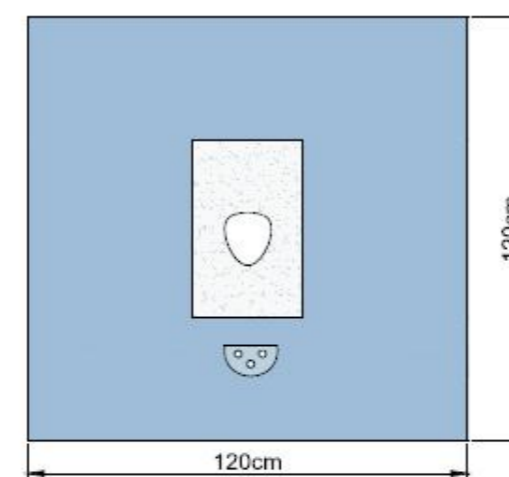

PM7701
 Face drape 120x120cm
 - Absorbent Reinforcement
 30x50cm
 - Fen 13x15cm
 - Tube Holders

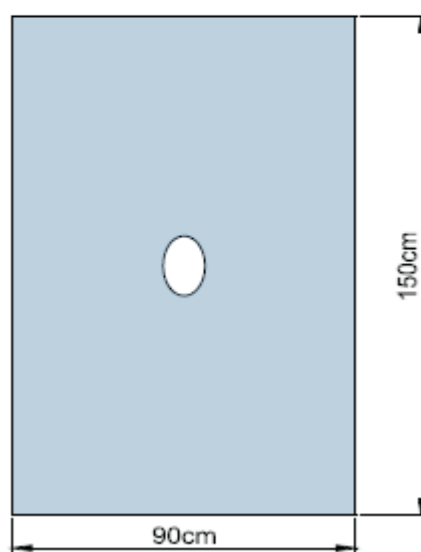

PM6573
 Fen drape 90x150cm
 - Oval 11x18cm

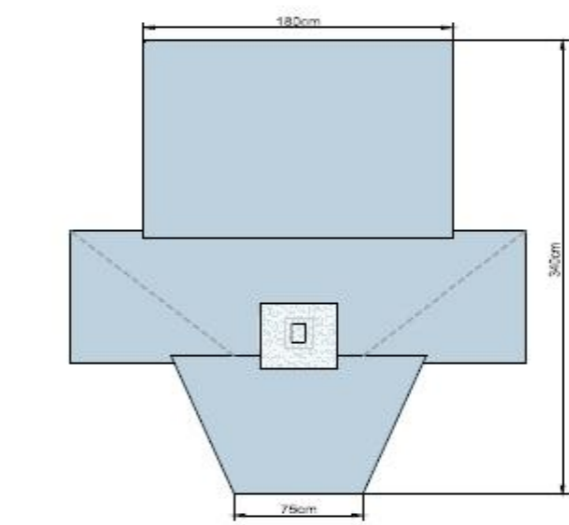

PM4072
 Gyn Uro Drape
 - Absorbent Reinforcement
 45x50cm
 - Fen 8x15cm
 - Adhesive

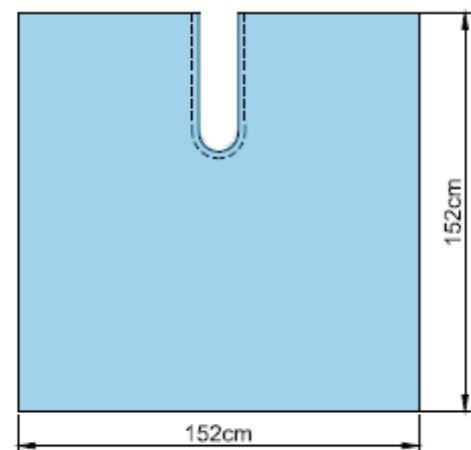

PM6473

- Poly U Drape
- 152x152cm
 - Split (15x53cm)
 - Adhesive

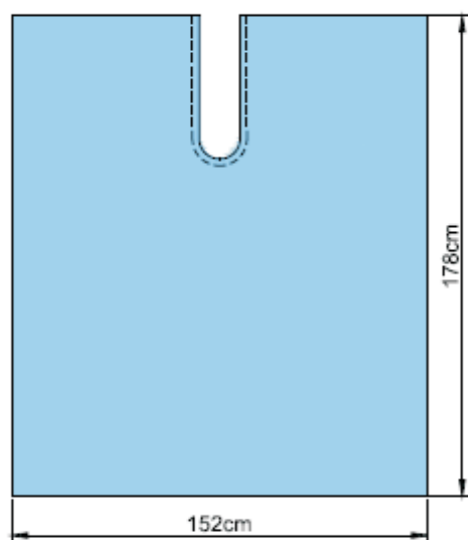

PM6471

- Poly U Drape
- 152x178cm
 - Split (15x53cm)
 - Adhesive

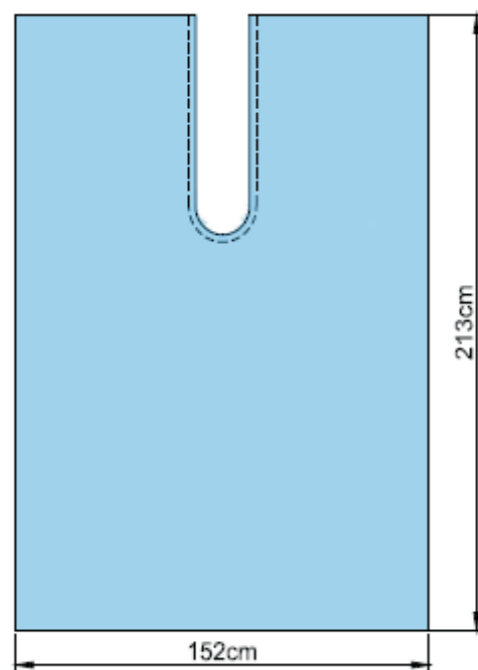

M6472

- Poly U Drape
- 152x213cm
 - Split (20x76cm)
 - Adhesive

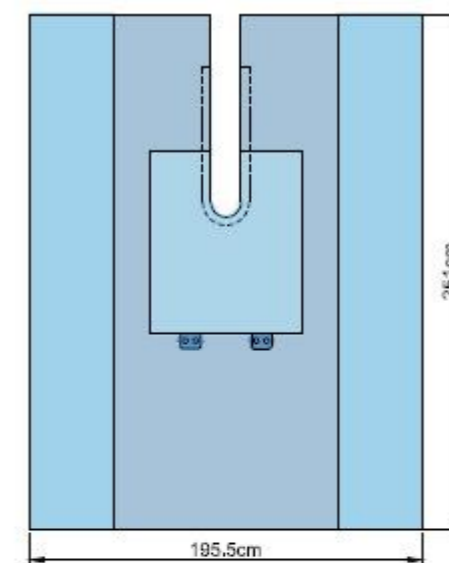

PM6402

- Split Sheet (Tri-Lam)
- Absorbent Reinforcement 76x89cm
 - Split (15x99cm)
 - Tube Holders
 - Adhesive

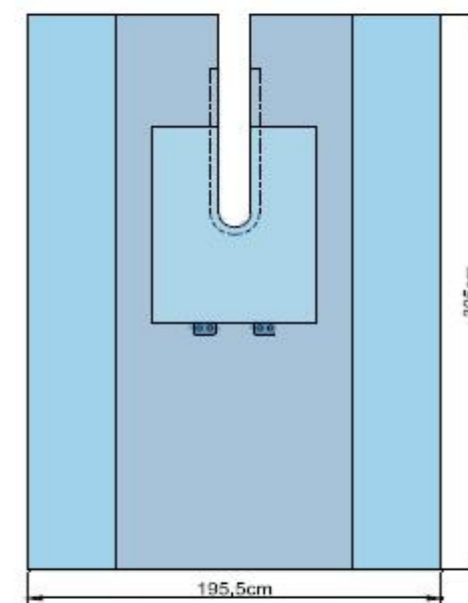

PM6403

- Split Sheet (Tri-Lam)
- Absorbent Reinforcement 77x107cm
 - Split (15x117cm)
 - Tube Holders
 - Adhesive

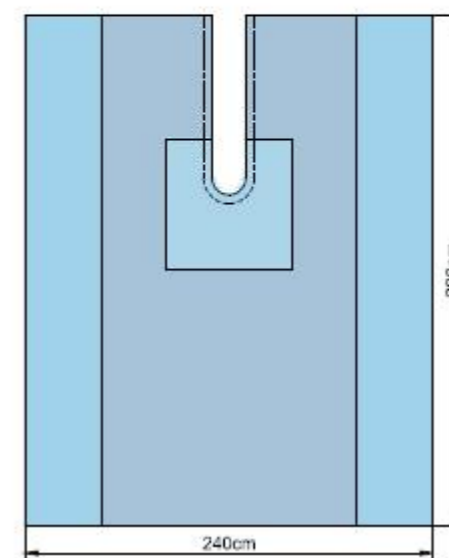

PM2016

- Split Sheet (Tri-Lam)
- Absorbent Reinforcement 74x74cm
 - Split (20x102cm)
 - Adhesive

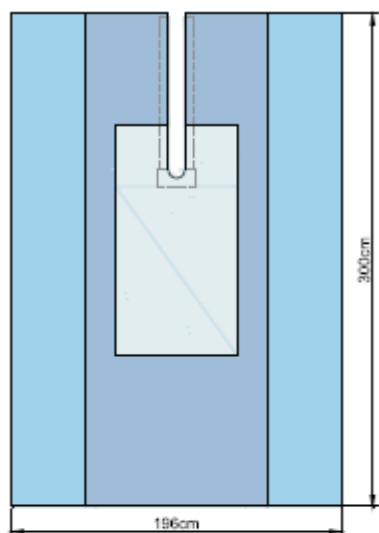

PM6410

Split Sheet

- Absorbent Reinforcement
40x60m
- Split (6.5x66cm)
- Adhesive

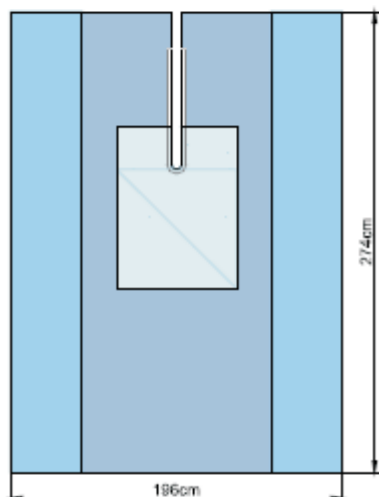

PM6412

Split Sheet

- Absorbent Reinforcement
72x96m
- Split (6.5x91cm)
- Adhesive

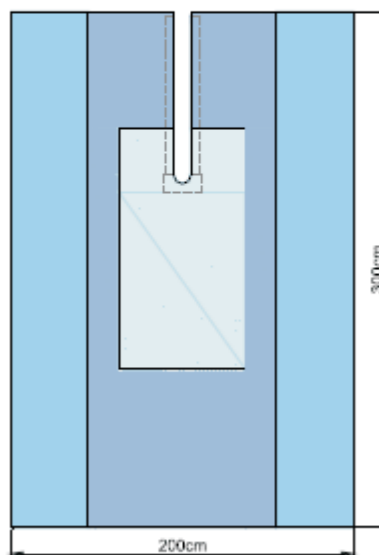

PM6413

Split Sheet (SMS)

- Absorbent Reinforcement
74x140m
- Split (10x100cm)
- Adhesive

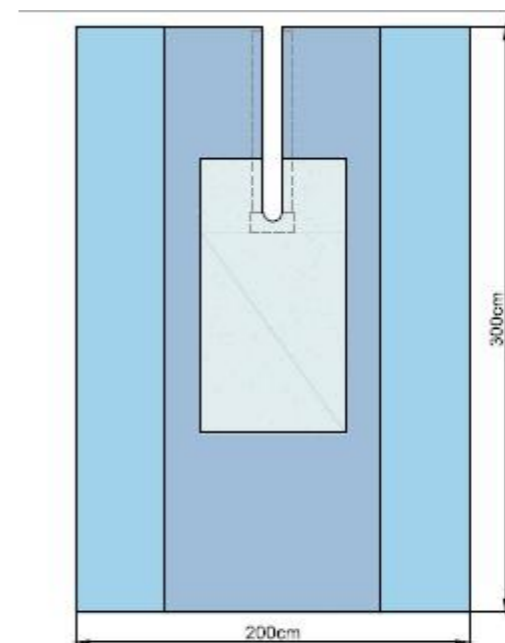

PM6414

Split Sheet (SMS)

- Absorbent Reinforcement
74x140m
- Split (15x100cm)
- Adhesive

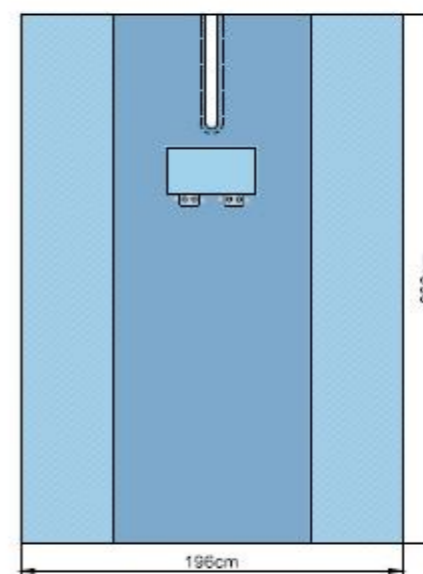

PM6405

Split Drape

- Absorbent Reinforcement
46x25cm
- Split 6.5x63cm
- Tube Holders
- Adhesive

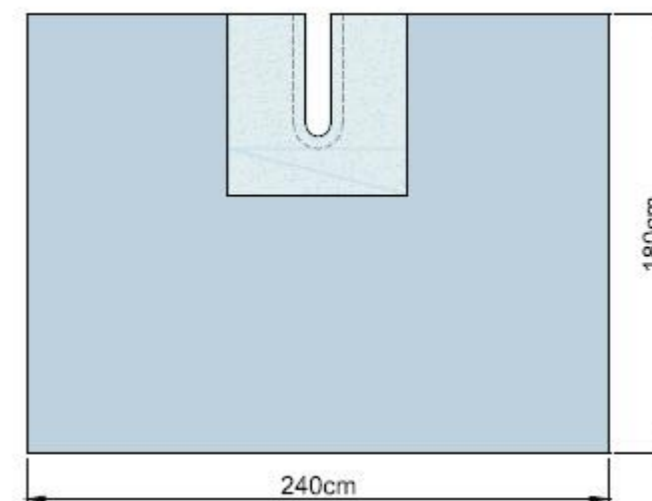

PM6411

Split Sheet

- Absorbent Reinforcement
74x74m
- Split (10x50cm)
- Adhesive

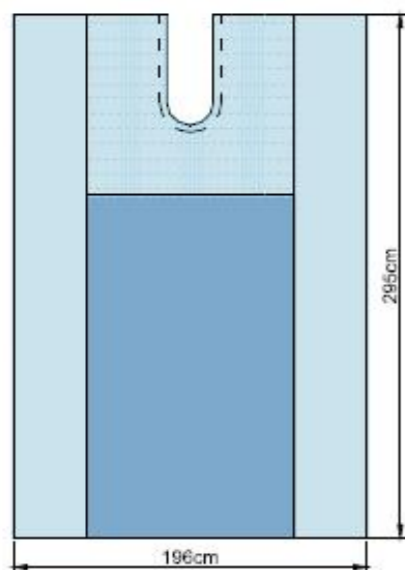

PM6404
 Body Split Drape
 - 25x64cm split
 100x112cm Absorbent
 Reinforcement

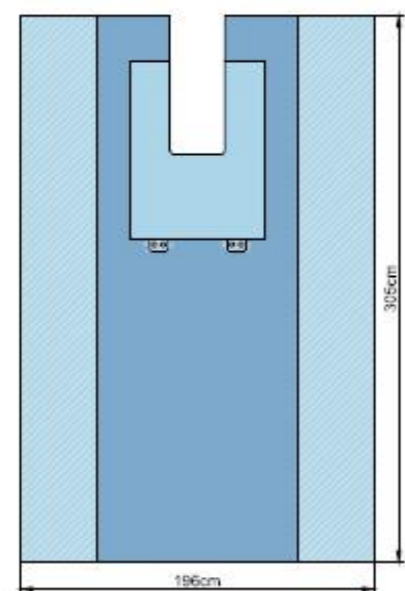

PM6451
 Chest/Breast U- Drape
 - Absorbent Reinforcement
 74 x 99cm
 - Split (28x77cm)

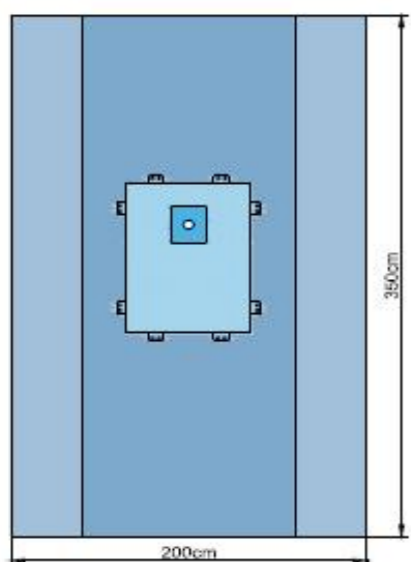

PM2018
 Extremity Drape (Tri-Lam) (200x350cm)
 - Absorbent Reinforcement
 70x100cm
 - Elastic Fenestration (20x25cm)
 - Tube Holders

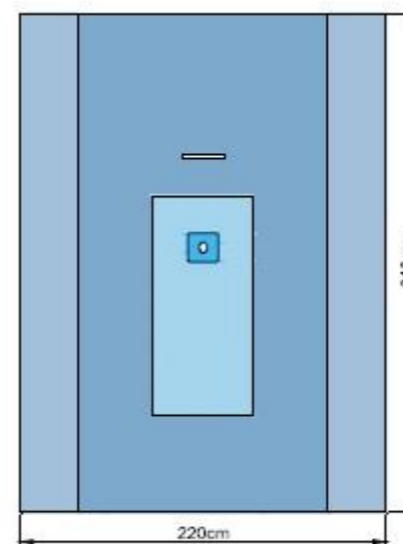

PM2019
 Extremity Drape (Tri-Lam) (220x318cm)
 - Absorbent Reinforcement
 60x140cm
 - Elastic Fenestration (18x18cm)
 - Adhesive

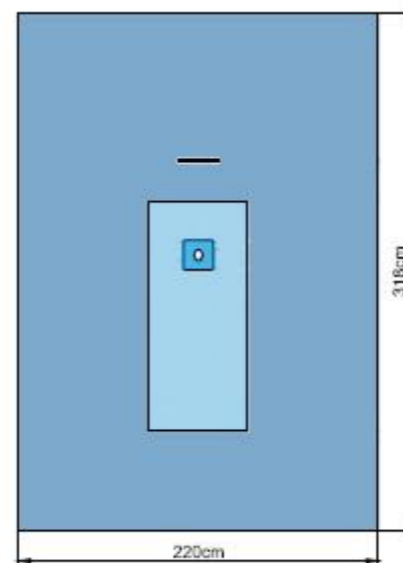

PM6807
 Extremity Drape (220x318cm)
 - Absorbent Reinforcement
 60x140cm
 - Elastic Fenestration (18x18cm)
 - Adhesive

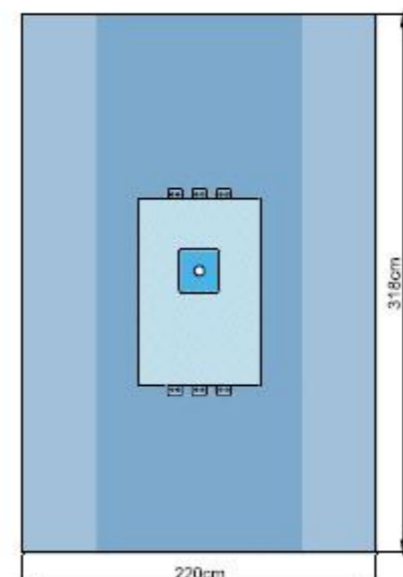

PM6801
 Extremity Sheet
 - 84x112cm Reinforcement
 - Circular Elastic Fenestration
 - Tube Holders

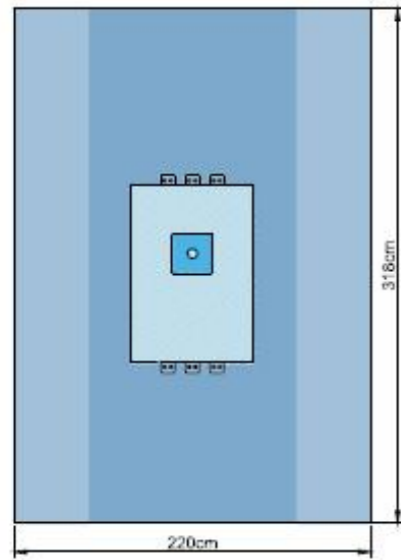

PM6802

Extremity Sheet

- 76x112cm Reinforcement
- Circular Elastic Fenestration
- Tube Holders

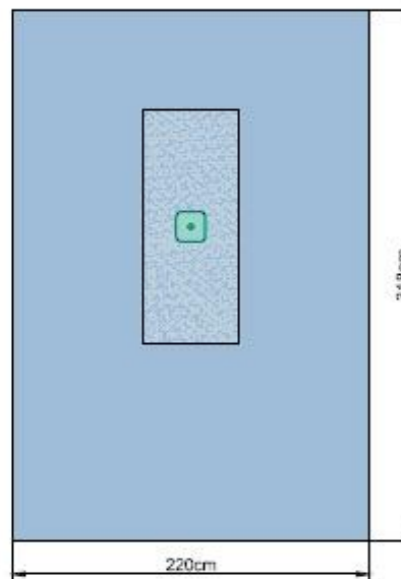

PM6804

Extremity Drape

- 60x140cm Reinforcement
- Circular Elastic Fenestration

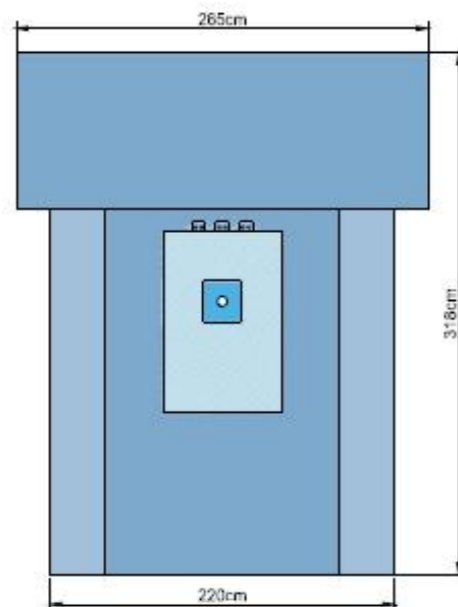

PM6806

Extremity Drape (Tri-Lam)
(265x318cm)

- Absorbent Reinforcement
76x112cm
- Elastic Fenestration (25x25cm)
- Tube Holders

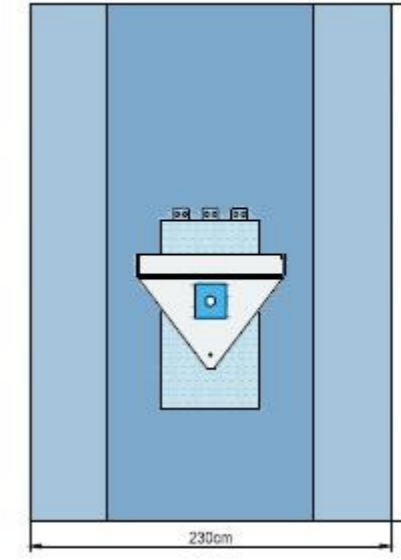

PM6805

Extremity Drape (Tri-Lam) (230x305cm)

- Absorbent Reinforcement
43x110cm
- Elastic Fenestration 20x20cm,
Hole Ø6.35cm
- Fluid Control Pouch
- Tube Holders

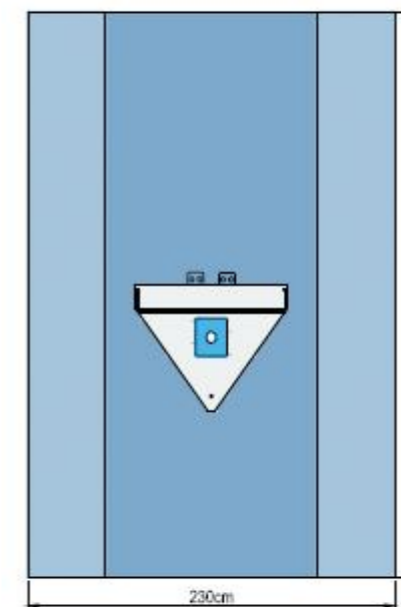

PM4051

Arthroscopy Sheet Drape (Tri-Lam)
(230x305cm)

- Fluid Control Pouch
- Absorbent Reinforcement
50x50cm
- Circular Elastic Fenestration
- Tube Holders

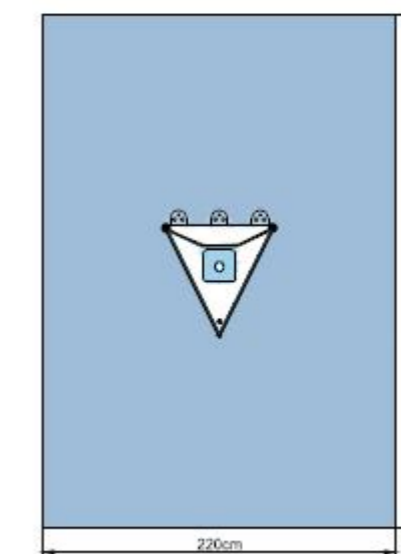

PM4075

Arthroscopy Drape
(220x320cm)

- Fluid Control Pouch
- Circular Elastic Fenestration
- Tube Holders

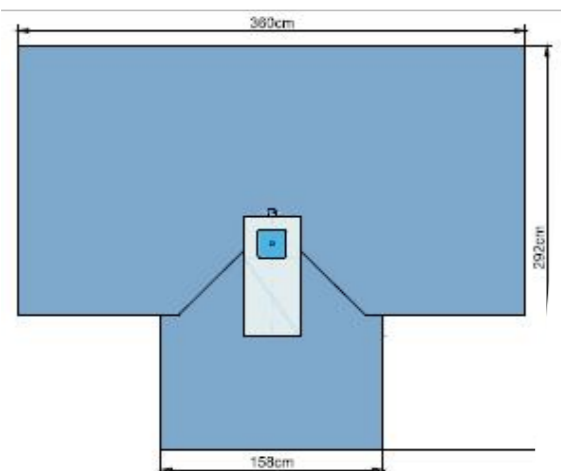

PM2022
 Hand Drape (Tri-Lam)
 (292x360cm)
 - Absorbent Reinforcement
 40x86cm
 - Elastic Fenestration (20x20cm)
 - Tube Holders

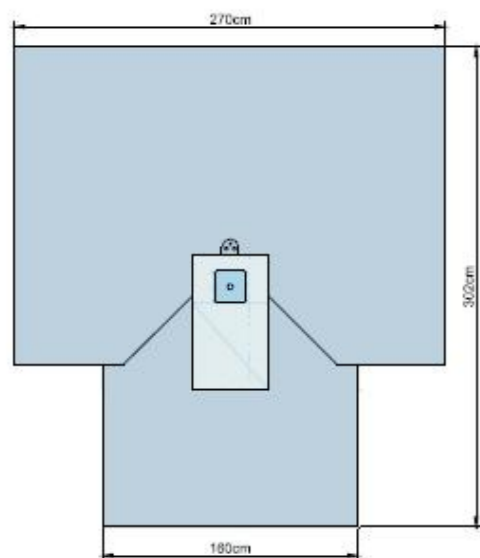

PM7801
 Hand Drape
 (270x302cm)
 - Absorbent Reinforcement
 48x85cm
 - Elastic Fenestration (20x20cm)
 - Tube Holders

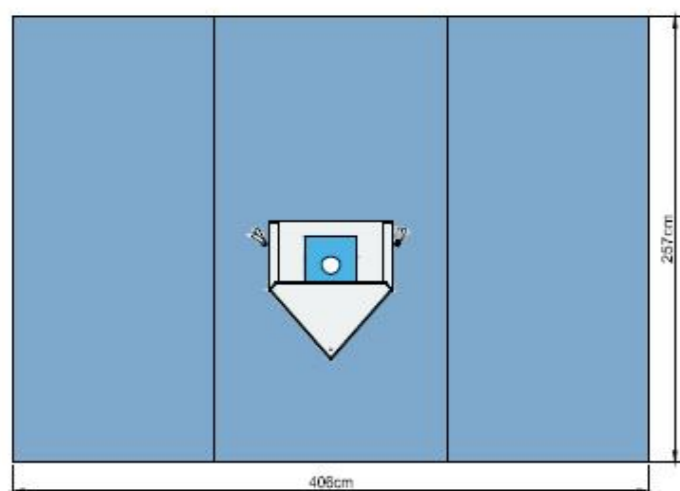

PM2023
 Shoulder Drape w/Pouch (Tri-Lam)
 (406x257cm)
 - Elastic Fenestration 20x20cm,
 Hole 12x10cm
 - Fluid Control Pouch
 - Velcro Tabs

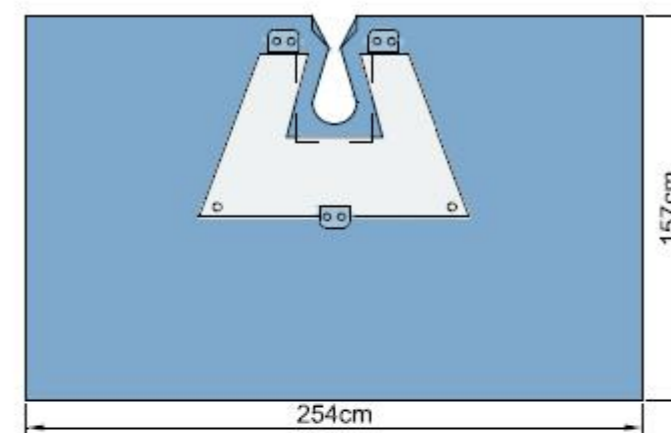

PM2024
 Shoulder Drape
 (254x157cm)
 - Fluid Control Pouch
 - Poly Reinforcement
 - Velcro Tabs

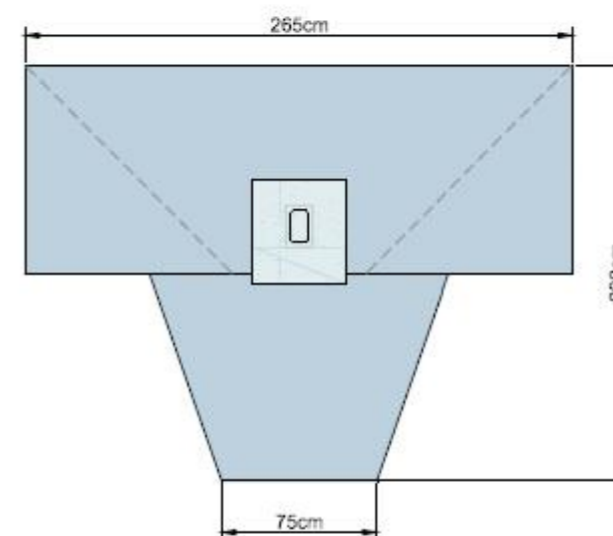

PM4074
 Gyn Uro Drape
 (265x200cm)
 - Absorbent Reinforcement
 45 x 50cm
 - Fenestration (8x15cm)
 - Adhesive

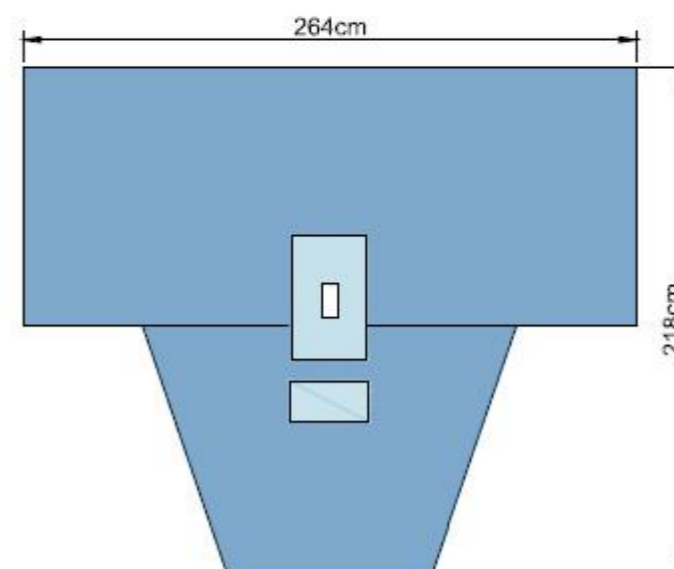

PM6701
 Cysto Sheet
 - Absorbent Reinforcement
 30 x 53cm
 - Fenestration (7.5x15cm)
 - Mesh

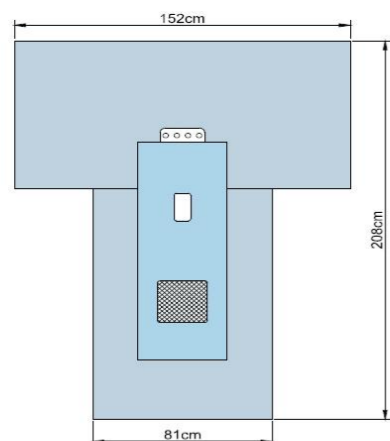

PM6702

Cystoscopy T Drape

- 40x119cm Absorbent Reinforcement
- 30 x 53cm
- Fenestration (7.5x15cm)
- Mesh

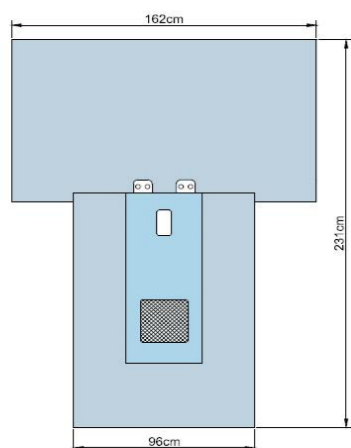

PM6703

Cystoscopy T Sheet

- Absorbent Reinforcement
- Fenestration (7.5x15cm)
- Tube holders
- Mesh

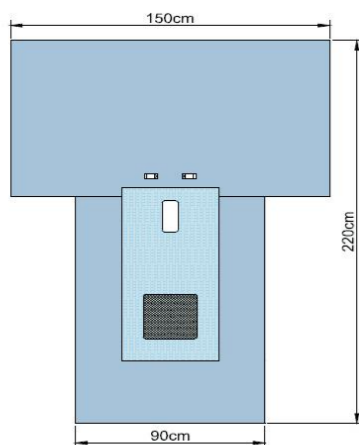

PM2027

Cystoscopy T Drape (Tri-Lam)

- Absorbent Reinforcement
- 45x100cm
- Fenestration (6x20cm)
- Mesh (25x25cm)
- Velcro Tabs

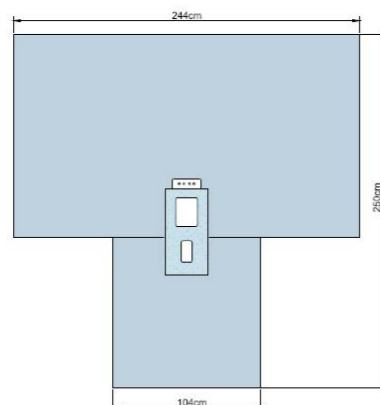

PM6671

Laparoscopy T Drape

- Absorbent Reinforcement
- Fenestration 7.5x15cm
- Fenestration 15x20cm
- Tube holders

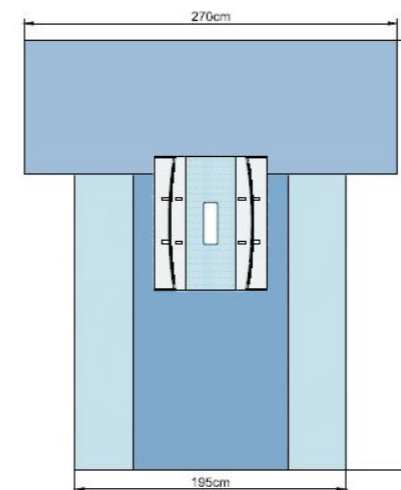

PM4008

Laparotomy Drape (Tri-Lam)

- Absorbent Reinforcement
- 35x96cm
- Fenestration (6x20cm)
- Adhesive
- Two Troughs

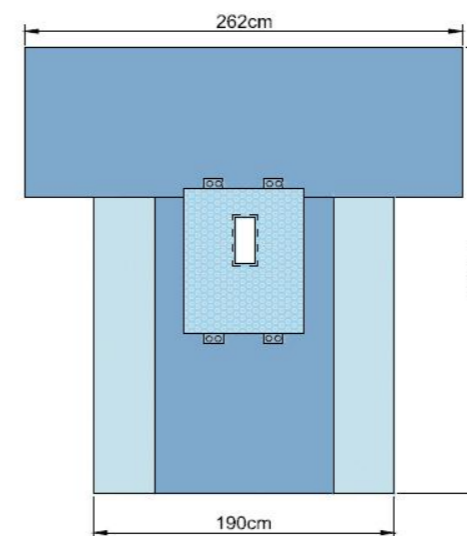

REF PM6604

Laparotomy Drape (Tri-Lam)

- Absorbent Reinforcement
- 86x110cm
- Fenestration (10x30cm)
- Adhesive
- Tube Holders

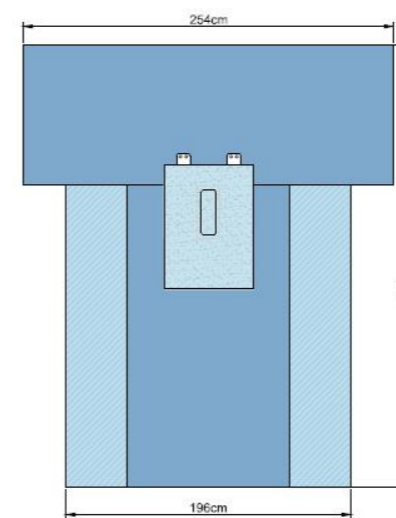

PM6601

Laparotomy Drape

- Absorbent Reinforcement
- 76x60cm
- Fenestration (10x30cm)
- Adhesive
- Tube Holders

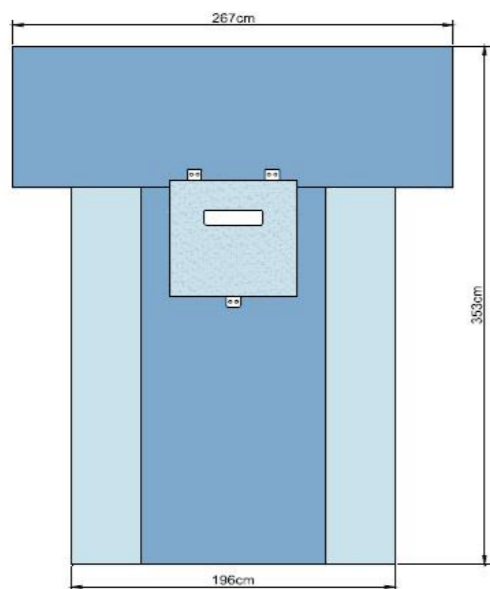

PM6602

- Laparoscopy T Drape
- Absorbent Reinforcement 65x66cm
 - Fenestration 10x35cm
 - Adhesive
 - Instrument Pad
 - Tube holders

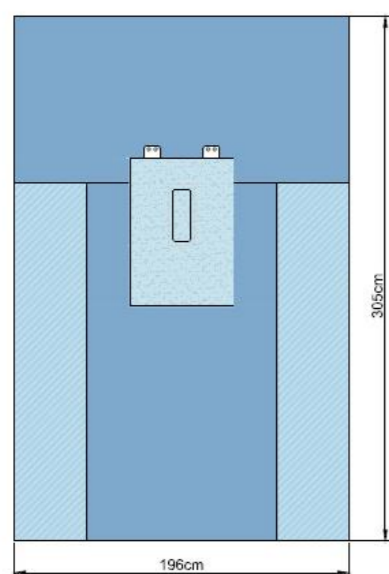

PM6603

- Laparoscopy Drape
- Absorbent Reinforcement 76x60cm
 - Fenestration 10x30cm
 - Adhesive
 - Tube holders

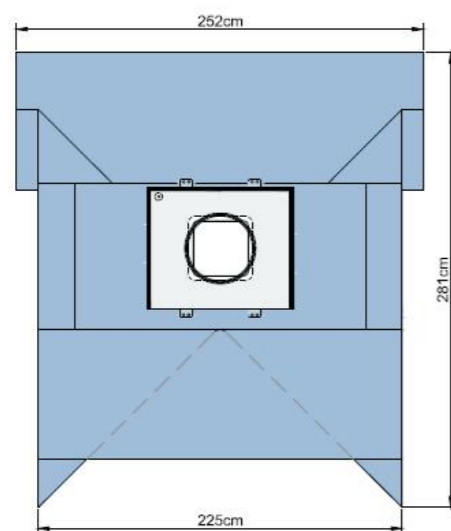

PM7203

- C-Section Drape
- Pouch 70x75cm
 - Fenestration 40cm
 - Tube holders

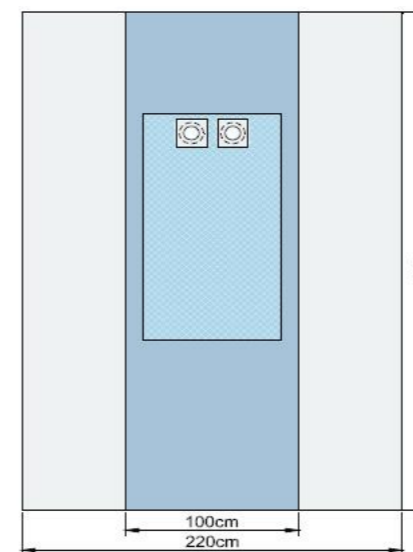

PM2028

- Angiography Drape (Tri-Lam)
- 220x330cm
- Absorbent Pad 80x150cm
 - Circular Fenestration

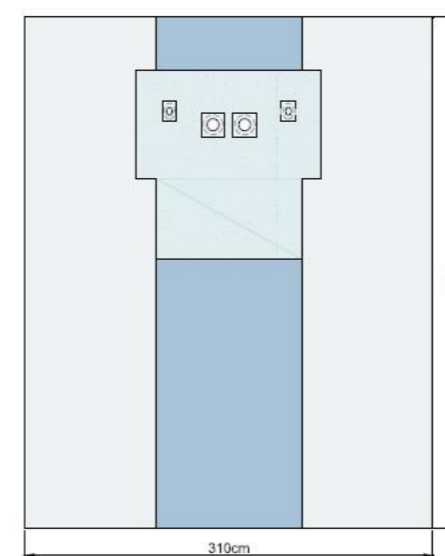

PM2029

- Angiography Drape (Tri-Lam)
- 310x380cm
- Absorbent Pad 140x140cm
 - Circular Fenestration

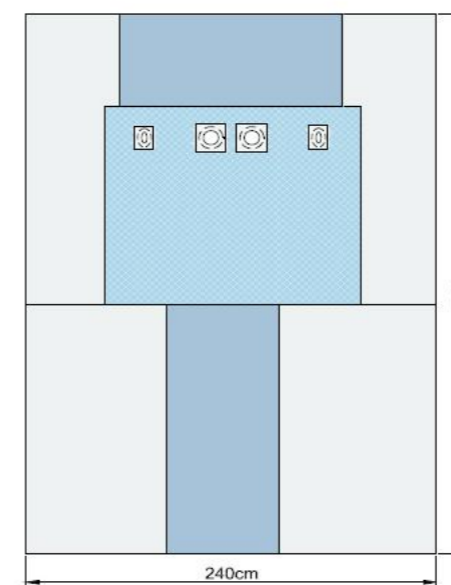

PM2030

- Angiography Drape (Tri-Lam)
- 240x345cm
- Absorbent Pad 150x127cm
 - Circular Fenestration

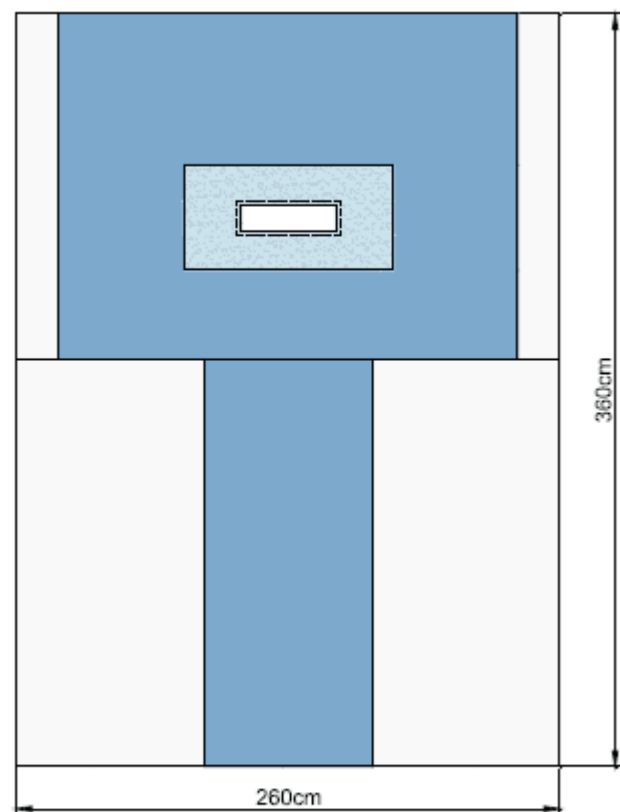

PM7601

Pacemaker tunnel drape (Tri-Lam)

260x360cm

- Absorbent Pad
100x50cm
- Fenestration (45x12 cm)
- Adhesive

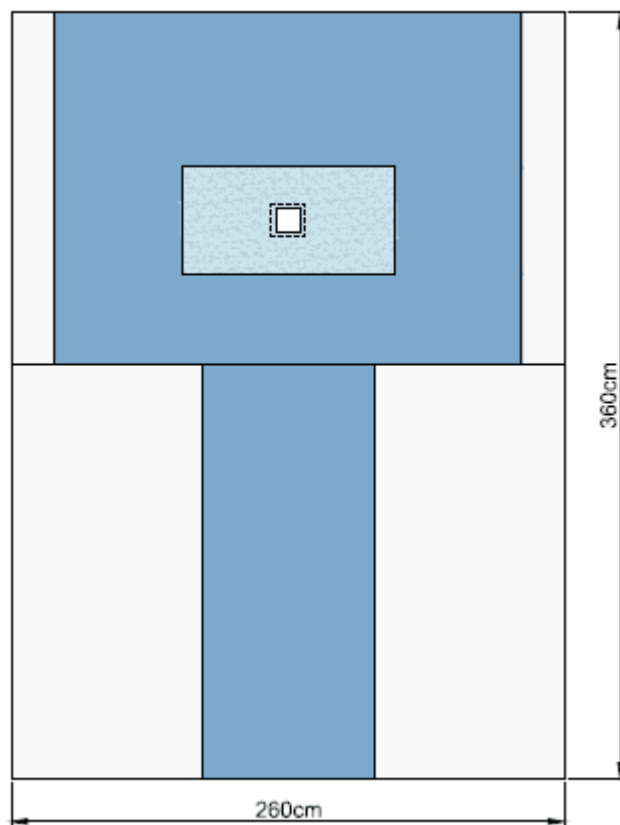

PM7602

Pacemaker tunnel drape (Tri-Lam)

260x360cm

- Absorbent Pad
100x50cm
- Fenestration (12x12 cm)
- Adhesive

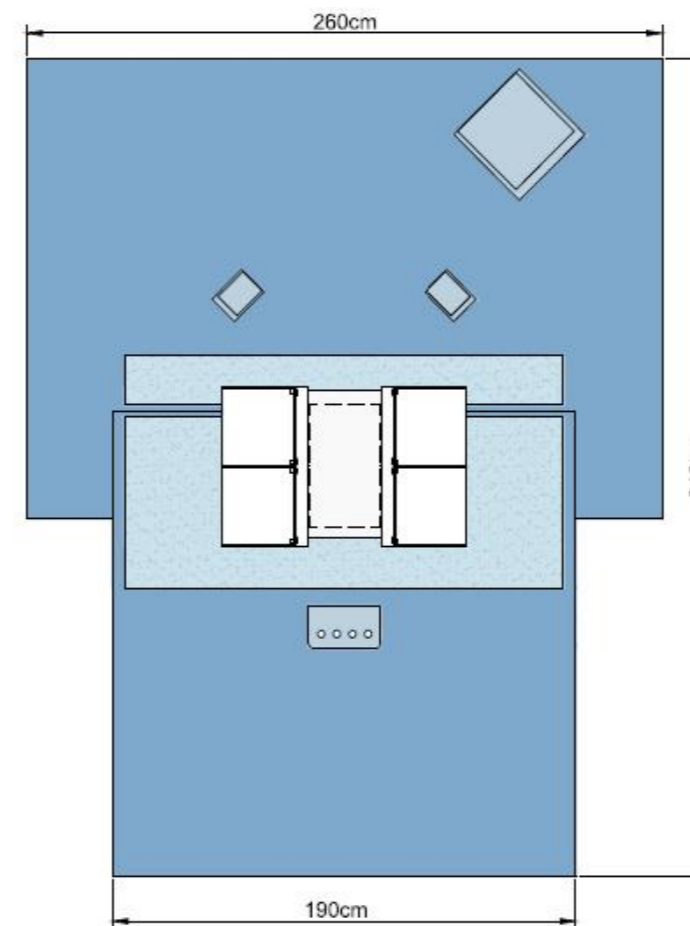

PM4071

Cardiovascular Drape (Bi-Lam)
(260x340cm)

- Absorbent Reinforcement
180x95cm
- Two Pouch 65x35cm
- Fenestration 50x29cm
- Tube Holders

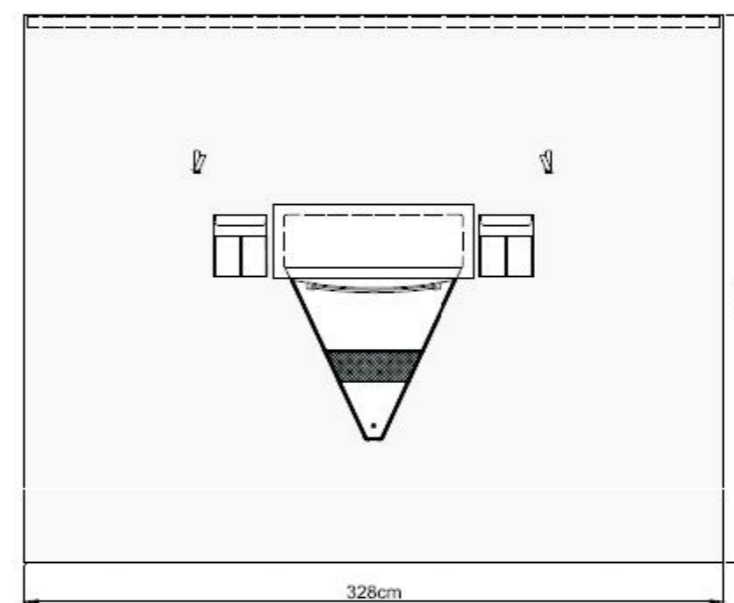

PM4073

Vertical isolation drape (328x240cm)

- Absorbent Reinforcement
180x95cm
- Two Pouch 65x35cm
- Fenestration 25.5x85cm
- Tube Holders

Surgical Packs

PM1003 Set Up Pack I

Part No.	Description	Size	Unit	Qty.
PM3201	Mayo Stand Cover	58x137cm	Each	1
PM4041	Suture Bag	16x28cm	Each	1
PM6571	Utility Drape	38x66cm	Each	4
PM3103	Back Table Cover	127x229cm	Each	1

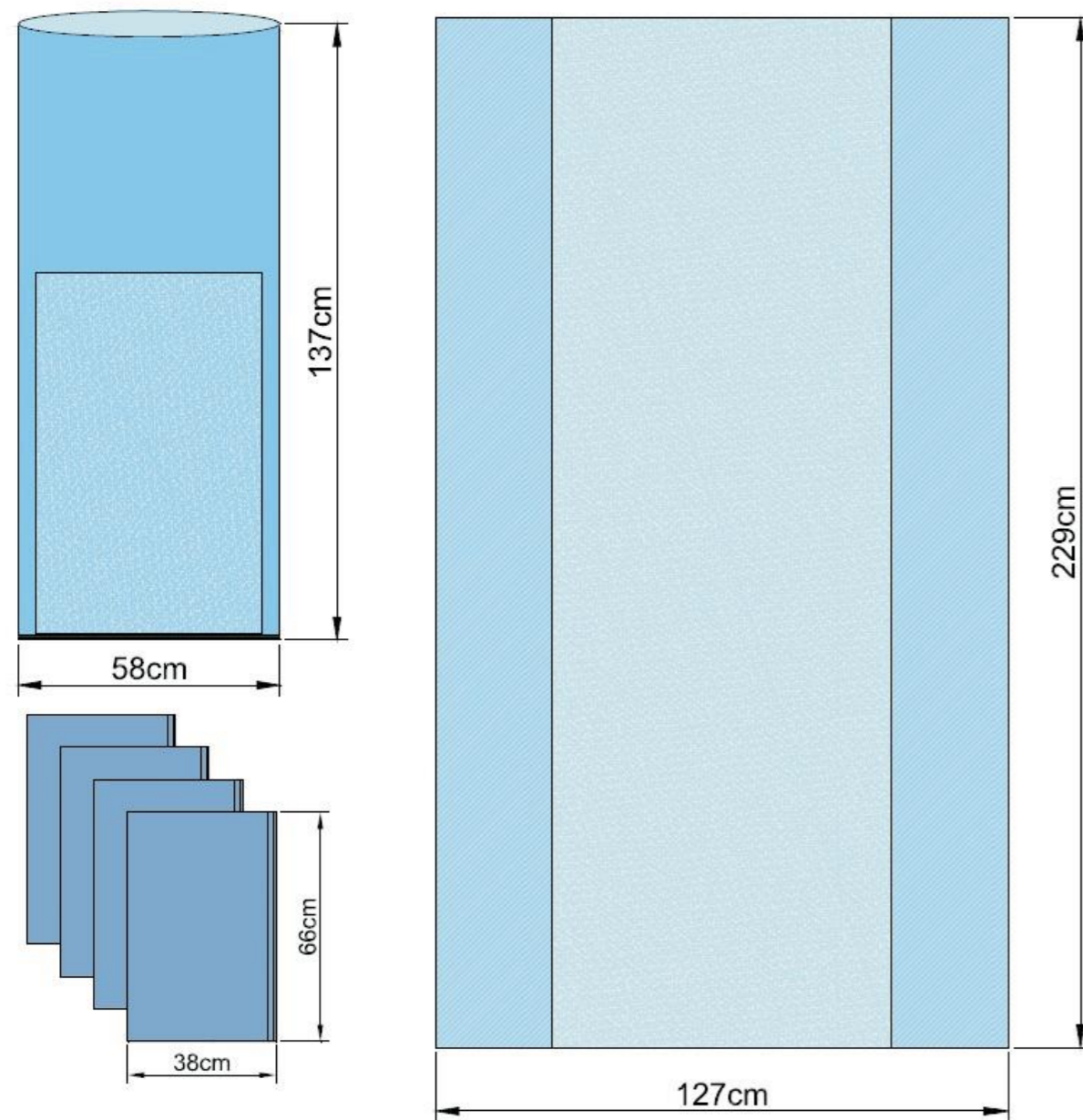

PM1002 Set Up Pack II

Part No.	Description	Size	Unit	Qty.
PM3201	Mayo Stand Cover	58x137cm	Each	1
PM4041	Suture Bag	16x28cm	Each	1
PM4000	Hand Towel	56x33cm	Each	1
PM3102	Back Table Cover	112x229cm	Each	1

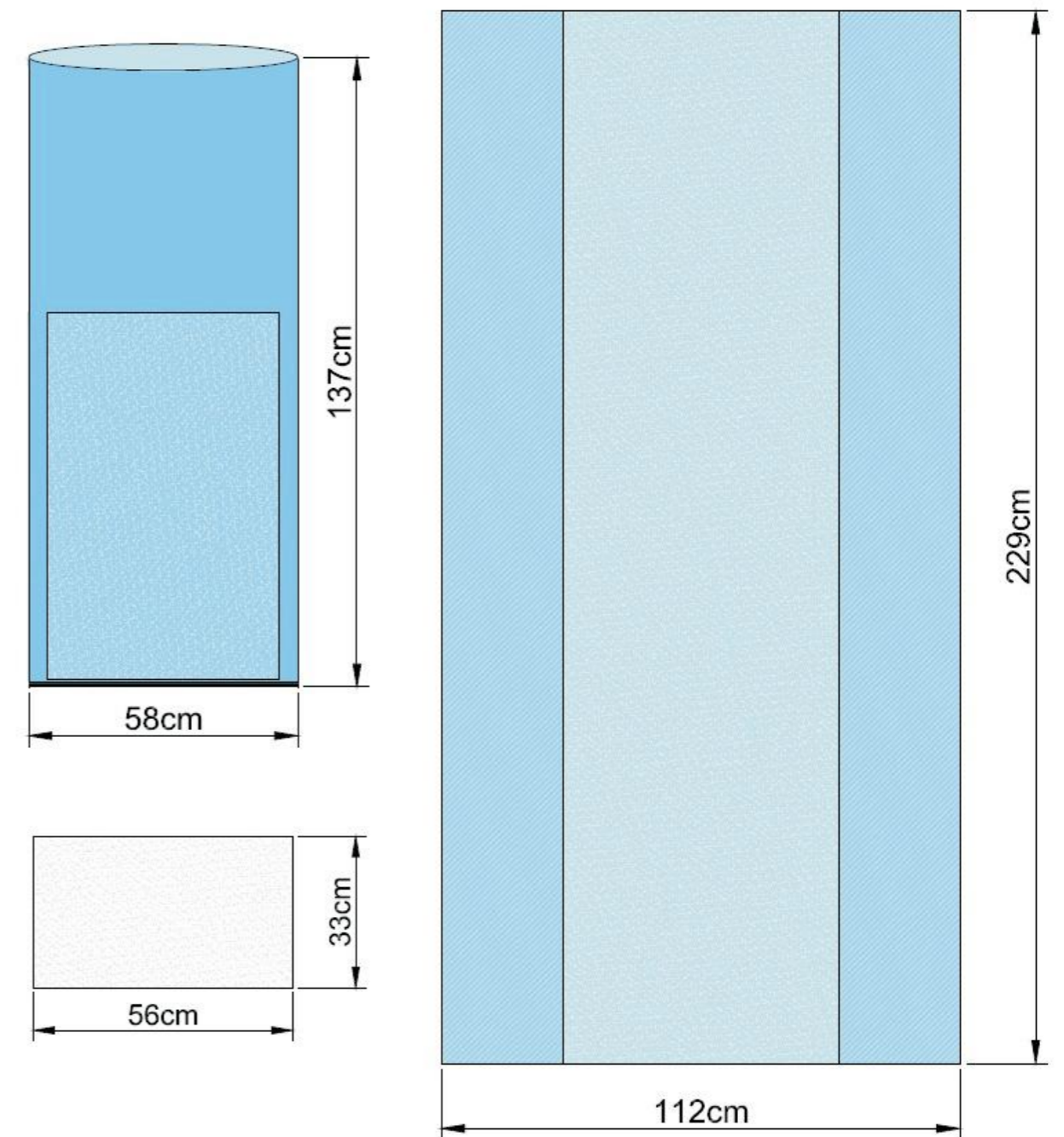

PM1022 Basic Pack I

Part No.	Description	Size	Unit	Qty.
PM3201	Mayo Stand Cover	58x137cm	Each	1
PM4041	Suture Bag	16x28cm	Each	1
PM4000	Hand Towel	56x33cm	Each	1
PM5107	Fab Reinf SMS Gown	Large	Each	1
PM5107W	Fab Reinf SMS Gown with Towel in Wrap	Large	Each	1
PM6571	Utility Drape	38x66cm	Each	4
PM6502	Three Quarter Drape	145x160cm	Each	1
PM3102	Back Table Cover	112x229cm	Each	1

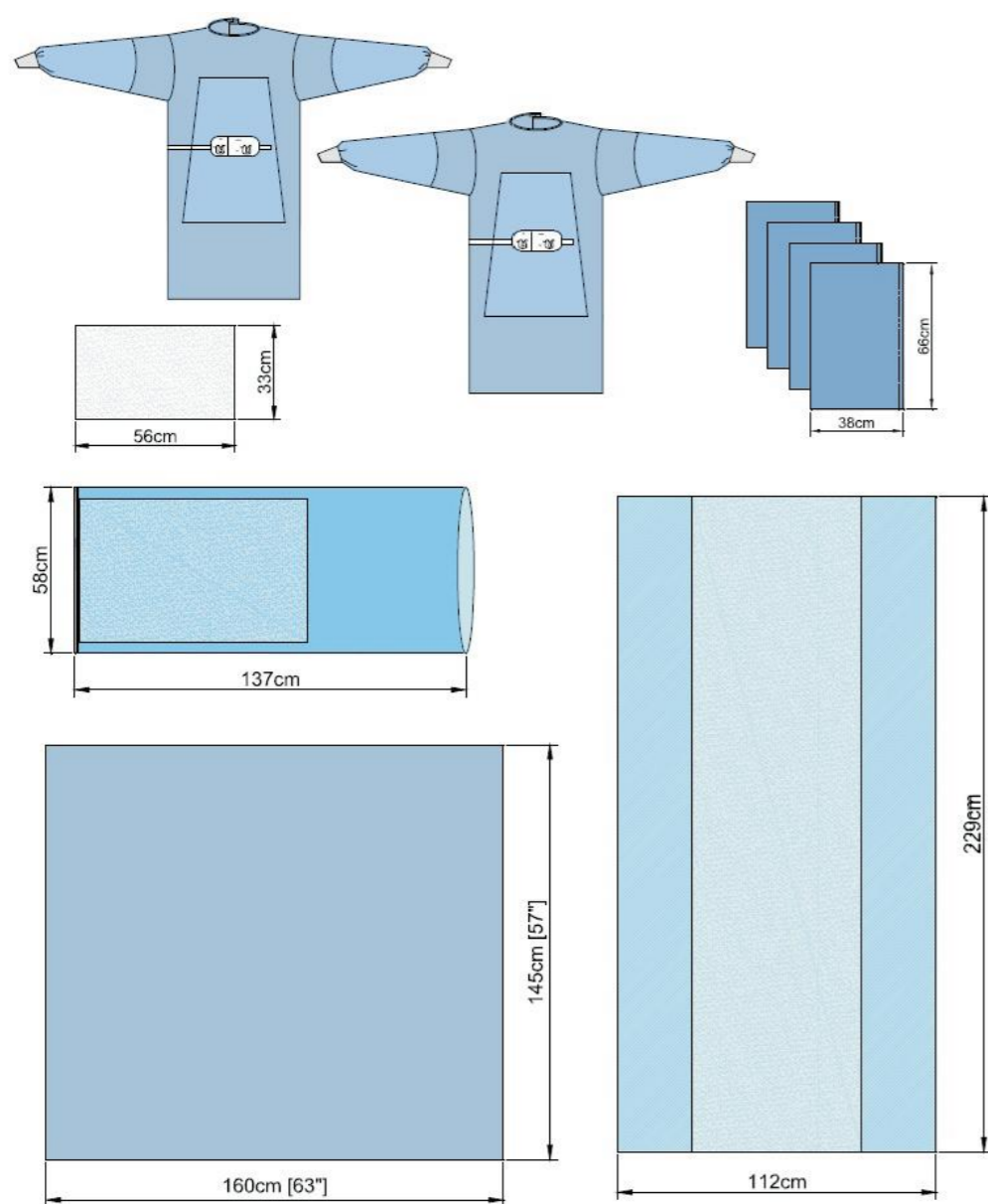

PM1023 Basic Pack II

Part No.	Description	Size	Unit	Qty.
PM3201	Mayo Stand Cover	58x137cm	Each	1
PM4041	Suture Bag	16x28cm	Each	1
PM4000	Hand Towel	56x33cm	Each	2
PM6571	Utility Drape	38x66cm	Each	4
PM3102	Back Table Cover	112x229cm	Each	1

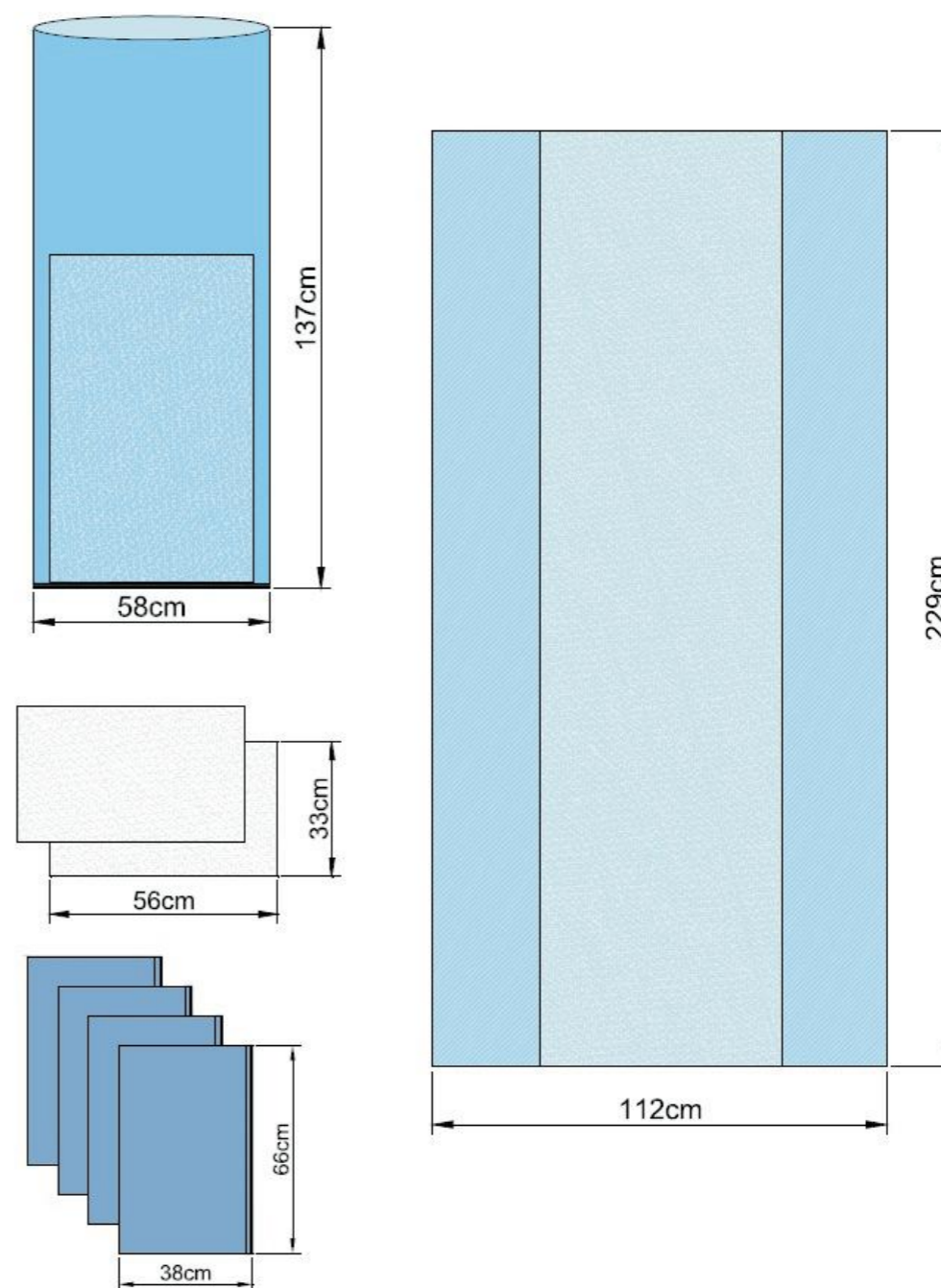

PM1024 Basic Pack III

Part No.	Description	Size	Unit	Qty.
PM4041	Suture Bag	16x28cm	Each	1
PM3201	Mayo Stand Cover	58x137cm	Each	1
PM6502	Three Quarter Drape	145x160cm	Each	1
PM3103	Back Table Cover	127x229cm	Each	1

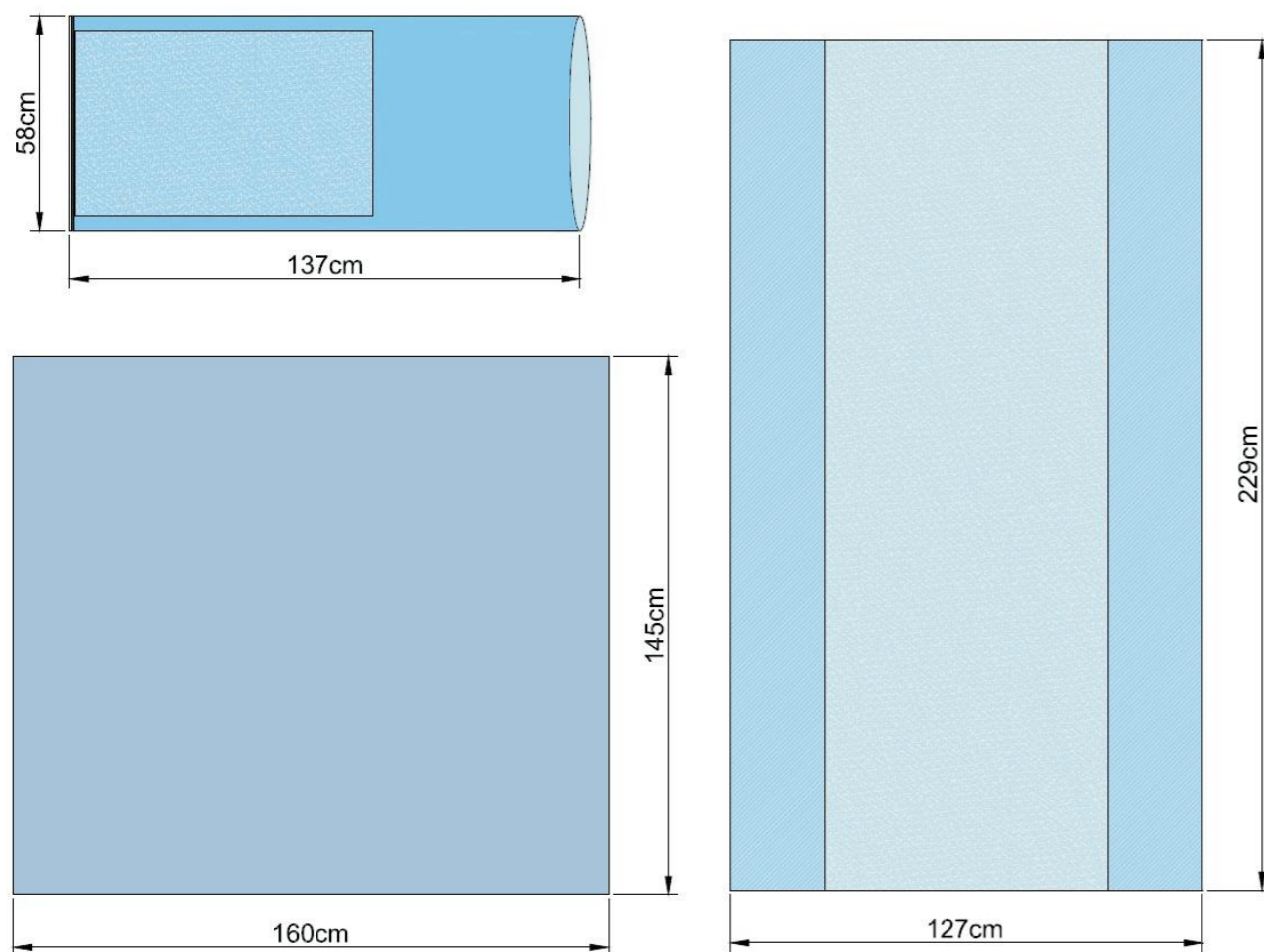

PM1025 Basic Pack IV

Part No.	Description	Size	Unit	Qty.
PM3201	Mayo Stand Cover	58x137cm	Each	1
PM4041	Suture Bag	16x28cm	Each	1
PM6571	Utility Drape	38x66cm	Each	4
PM6502	Three Quarter Drape	145x160cm	Each	1
PM3102	Back Table Cover	112x229cm	Each	1

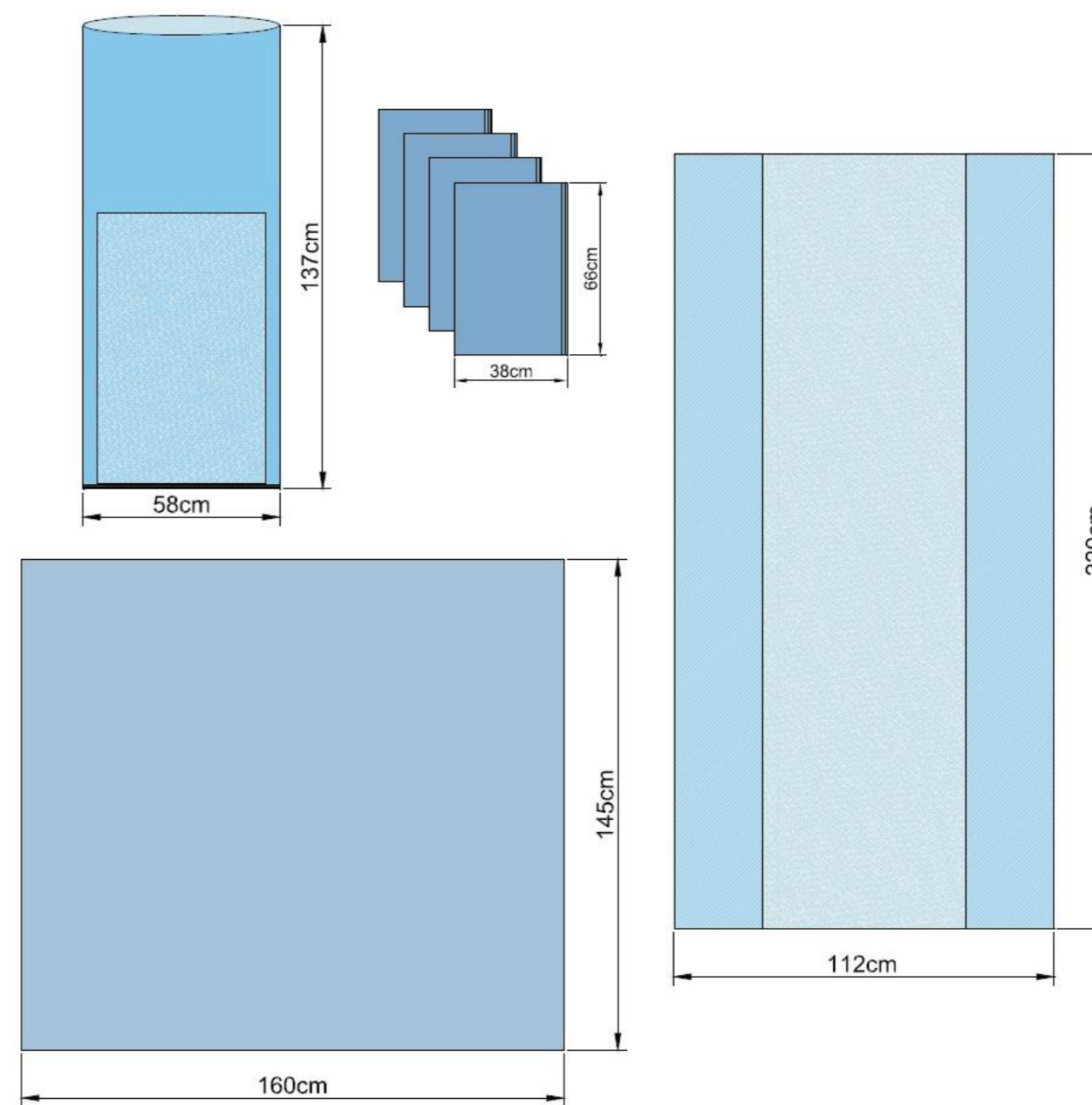

PM1026 Basic Pack V

Part No.	Description	Size	Unit	Qty.
PM3201	Mayo Stand Cover	58x137cm	Each	1
PM4041	Suture Bag	16x28cm	Each	1
PM5101	Standard SMS Gown, Large	Large	Each	1
PM5101TW	Standard SMS Gown with Towel in Wrap, Large	Large	Each	1
PM6571	Utility Drape	38x66cm	Each	4
PM3103	Back Table Cover	127x 29cm	Each	1

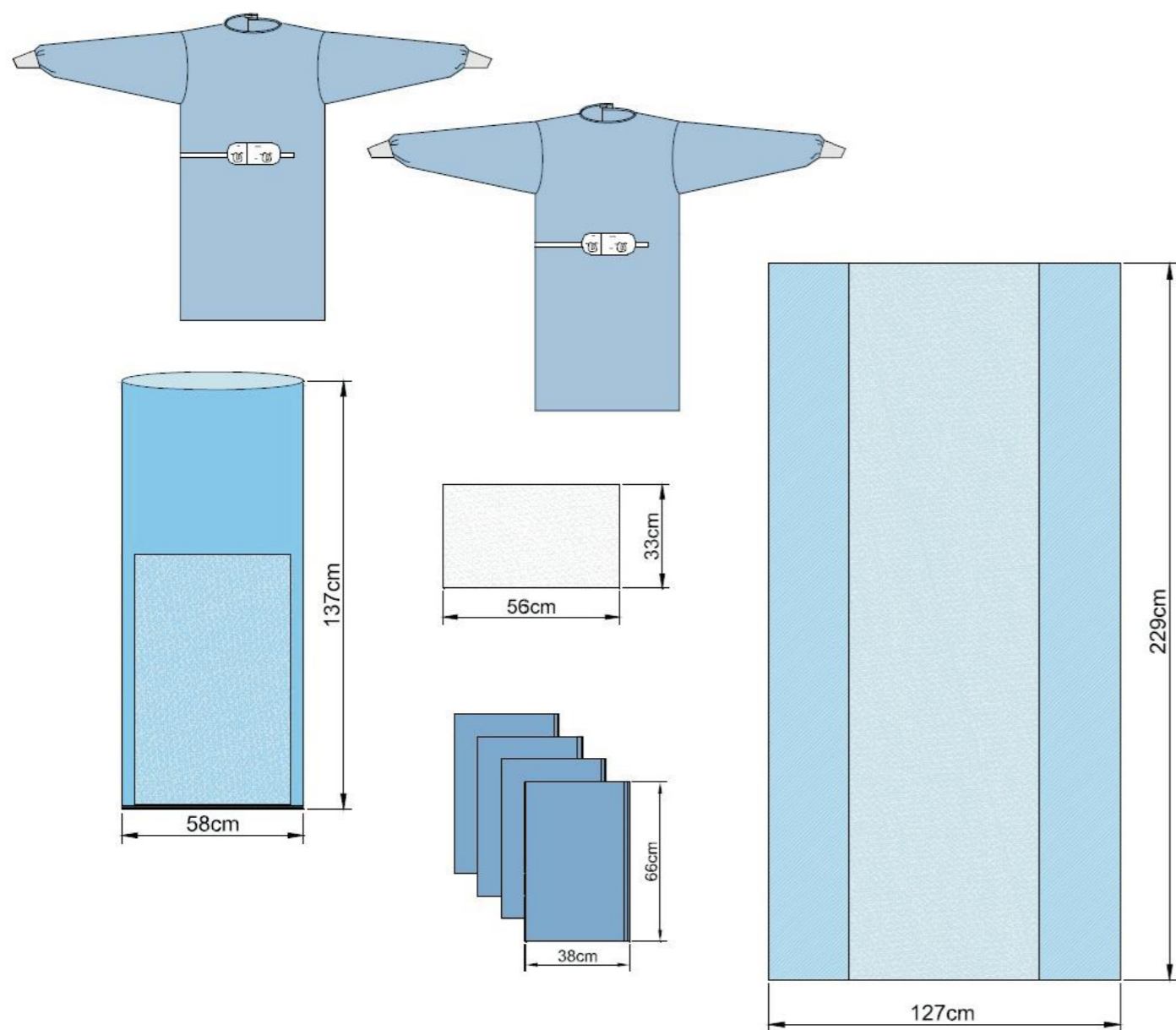

PM1027 Basic Pack VI

Part No.	Description	Size	Unit	Qty.
PM3201	Mayo Stand Cover	58x137cm	Each	1
PM4041	Suture Bag	16x28cm	Each	1
PM5101	Standard SMS Gown, Large	Large	Each	1
PM5101TW	Standard SMS Gown with Towel in Wrap, Large	Large	Each	1
PM6571	Utility Drape	38x66cm	Each	4
PM6502	Three Quarter Drape	145x160cm	Each	1
PM6501	Half Drape	106x145cm	Each	1
PM3102	Back Table Cover	112x229cm	Each	1

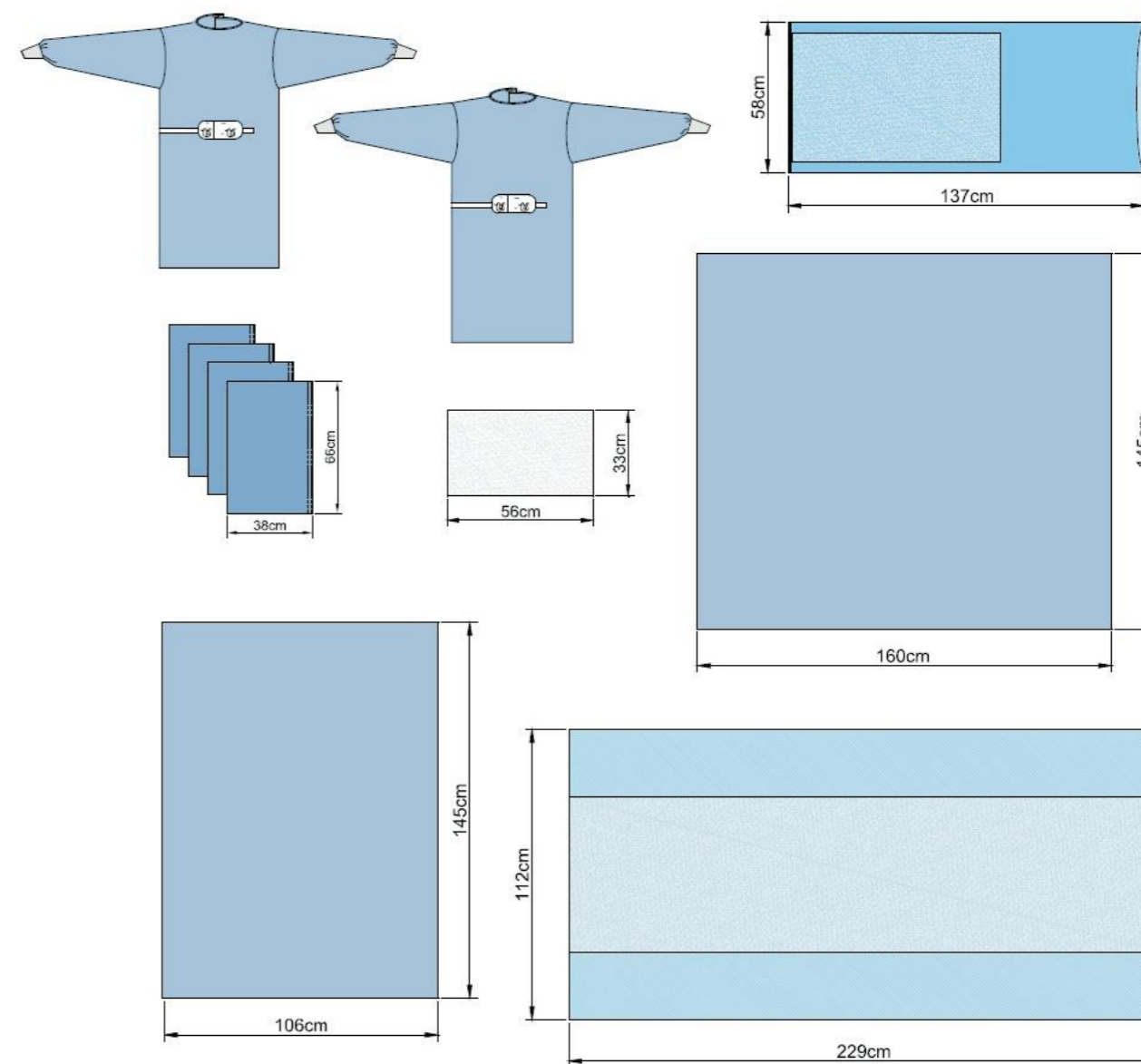

PM1028 Basic Pack VII

Part No.	Description	Size	Unit	Qty.
PM3201	Mayo Stand Cover	58x137cm	Each	1
PM4041	Suture Bag	16x28cm	Each	1
PM5101	Standard SMS Gown, Large	Large	Each	1
PM5101W	Standard SMS Gown with Towel in Wrap, Large	Large	Each	1
PM6571	Utility Drape	38x66cm	Each	4
PM6502	Three Quarter Drape	145x160cm	Each	1
PM3102	Back Table Cover	112x229cm	Each	1

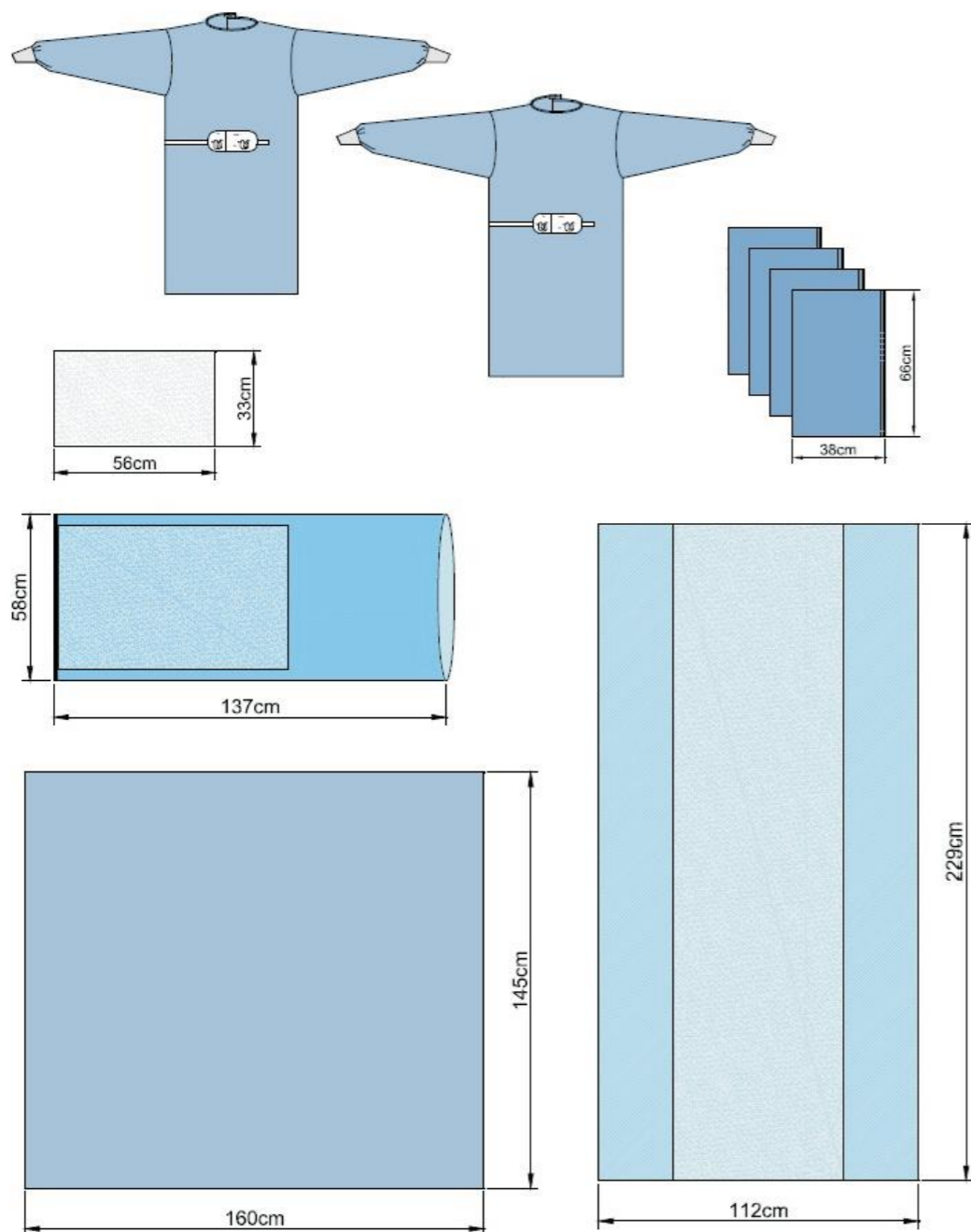

PM1029 Basic Pack VIII

Part No.	Description	Size	Unit	Qty.
PM3201	Mayo Stand Cover	58x137cm	Each	1
PM4041	Suture Bag	16x28cm	Each	1
PM6571	Utility Drape	38x66cm	Each	4
PM6501	Half Drape	106x145cm	Each	1
PM6502	Three Quarter Drape	145x160cm	Each	1
PM3102	Back Table Cover	112x229cm	Each	1

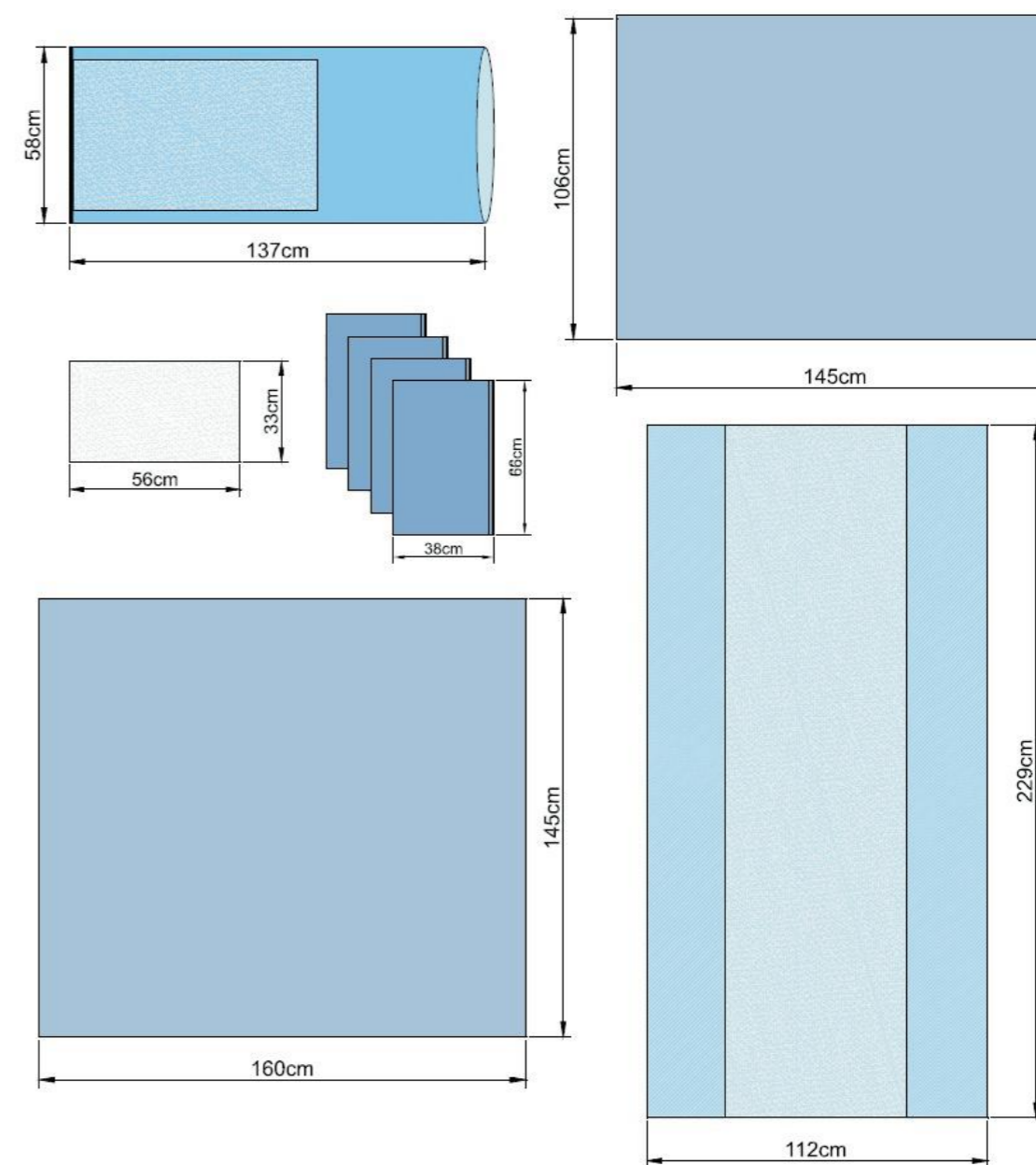

PM1041 Universal Pack I

Part No.	Description	Size	Unit	Qty.
PM3201	Mayo Stand Cover	58x137cm	Each	1
PM4000	Hand Towel	56x33cm	Each	1
PM5101	Standard SMS Gown, Large	Large	Each	1
PM5101W	Standard SMS Gown with Towel in Wrap, Large	Large	Each	1
PM4041	Suture Bag	16x28cm	Each	1
PM6571	Utility Drape	38x66cm	Each	4
PM6301	Side Drape	196x94cm	Each	2
PM6101	Head Drape	249x135cm	Each	1
PM6202	Foot Drape	188x180cm	Each	1
PM3102	Back Table Cover	112x229cm	Each	1

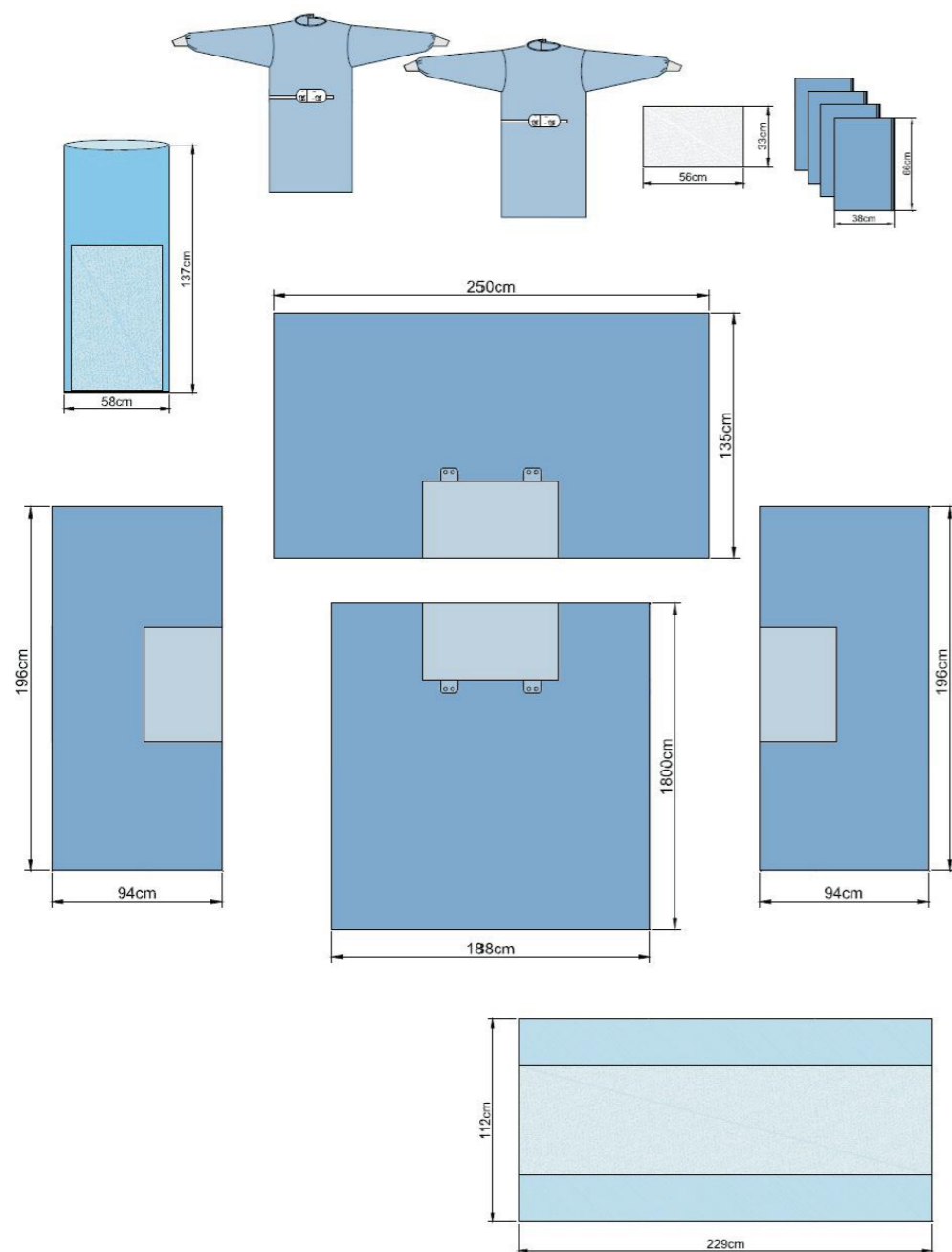

PM1042 Universal Pack II

Part No.	Description	Size	Unit	Qty.
PM3201	Mayo Stand Cover	58x137cm	Each	1
PM4541	Suture Bag	16x28cm	Each	1
PM6571	Utility Drape	38x66cm	Each	4
PM6451	Chest/Breast U-Drape	196x305cm	Each	1
PM4055	Bar Drape	269x157cm	Each	1
PM3103	Back Table Cover	127x229cm	Each	1

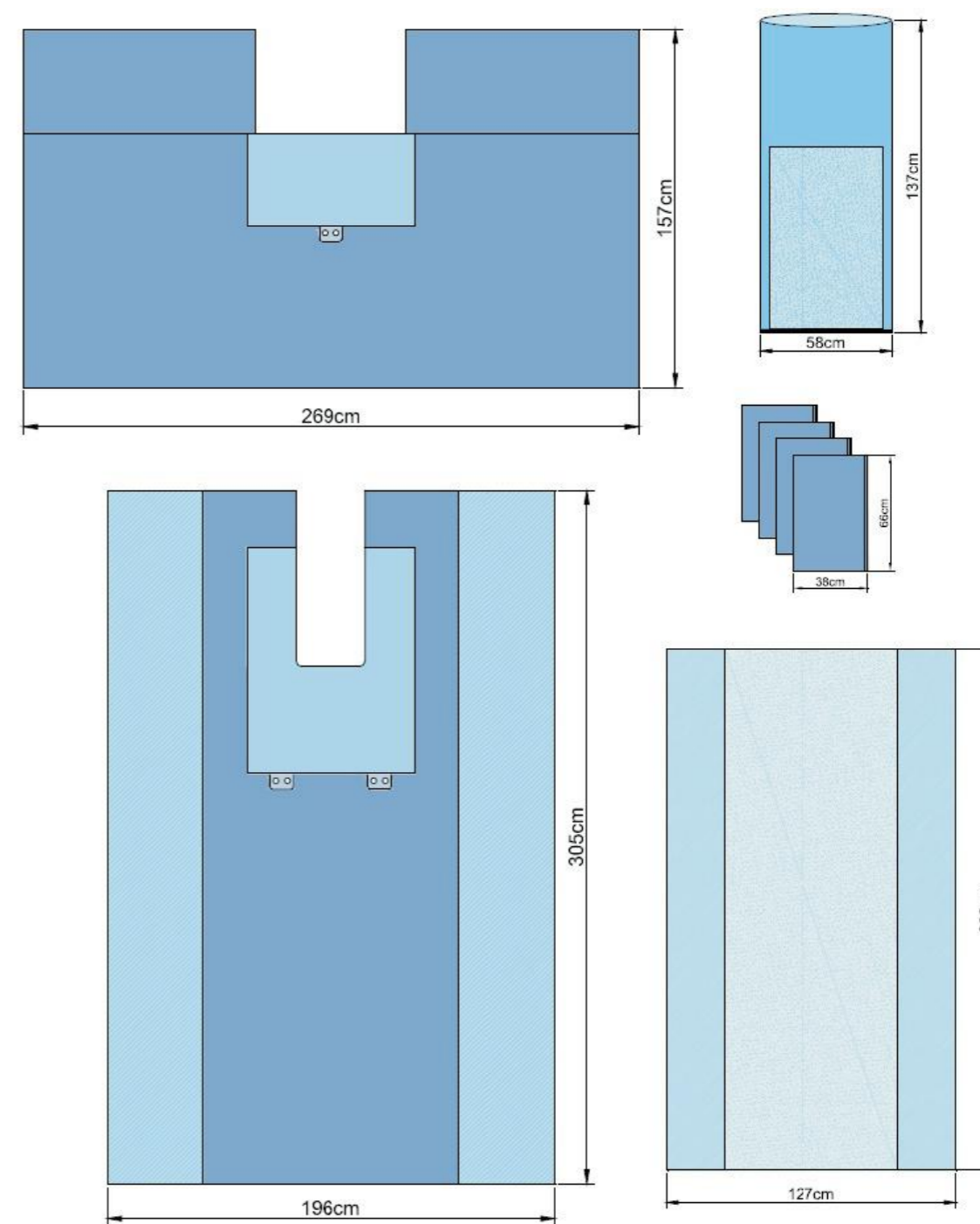

PM1000 Universal Pack III

Part No.	Description	Size	Unit	Qty.
PM4034T	Top Drape	240x150cm	Each	1
PM6302	Side Drape	100x90cm	Each	2
PM4035T	Bottom Drape	175x175cm	Each	1
PM3202	Mayo Stand Cover	76x145cm	Each	1
PM4042	Tape Strip	10x50cm	Each	2
PM4000	Hand Towel	56x33cm	Each	2
PM3106	Back Table Cover	150x200cm	Each	1

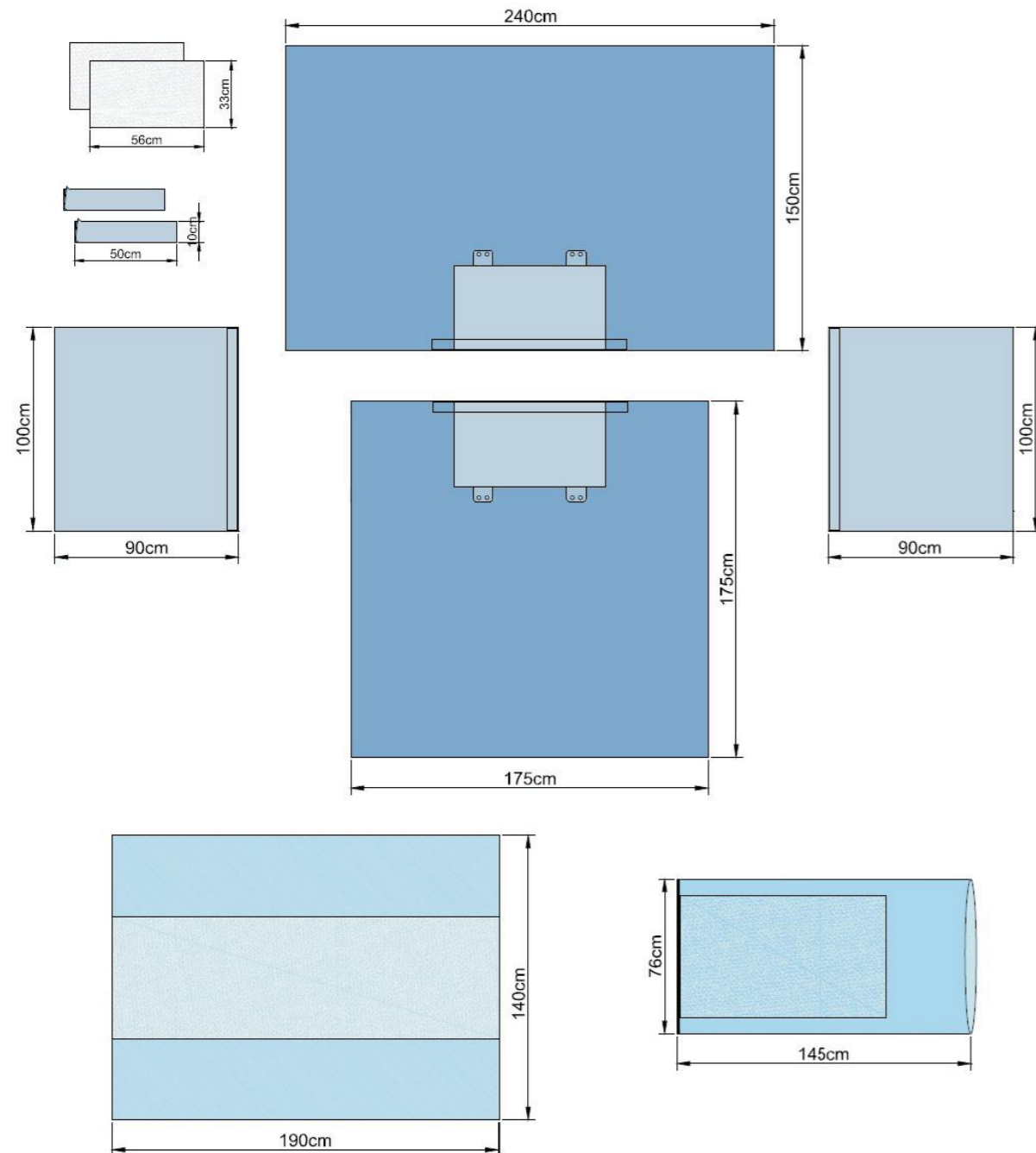

PM1008 Universal Split Pack

Part No.	Description	Size	Unit	Qty.
PM3201	Mayo Stand Cover	58x137cm	Each	1
PM4041	Suture Bag	16x28cm	Each	1
PM6571	Utility Drape	38x66cm	Each	4
PM6403	Split Drape	196x305cm	Each	1
PM6103	Top Drape	251x135cm	Each	1
PM3102	Back Table Cover	112x229cm	Each	1

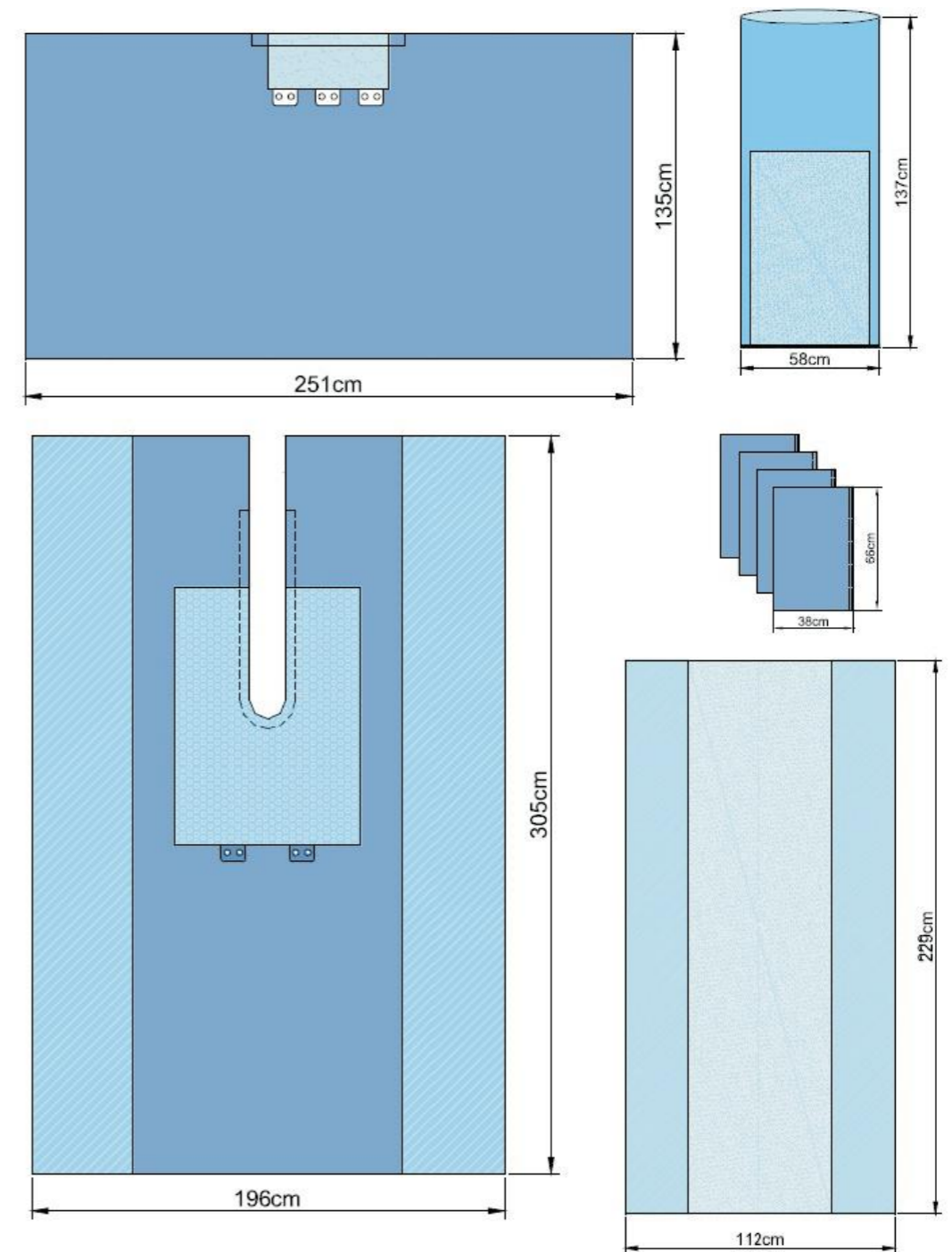

PM1045 Universal U-Bar Pack

Part No.	Description	Size	Unit	Qty.
PM6102	Top Drape	157x270cm	Each	1
PM6302	Side Drape	100x90cm	Each	2
PM4035T	Bottom Drape	175x175cm	Each	1
PM3202	Mayo Stand Cover	76x145cm	Each	1
PM4042	Tape Strip	10x50cm	Each	1
PM4000	Hand Towel	56x33cm	Each	2
PM3106	Back Table Cover	150x200cm	Each	1

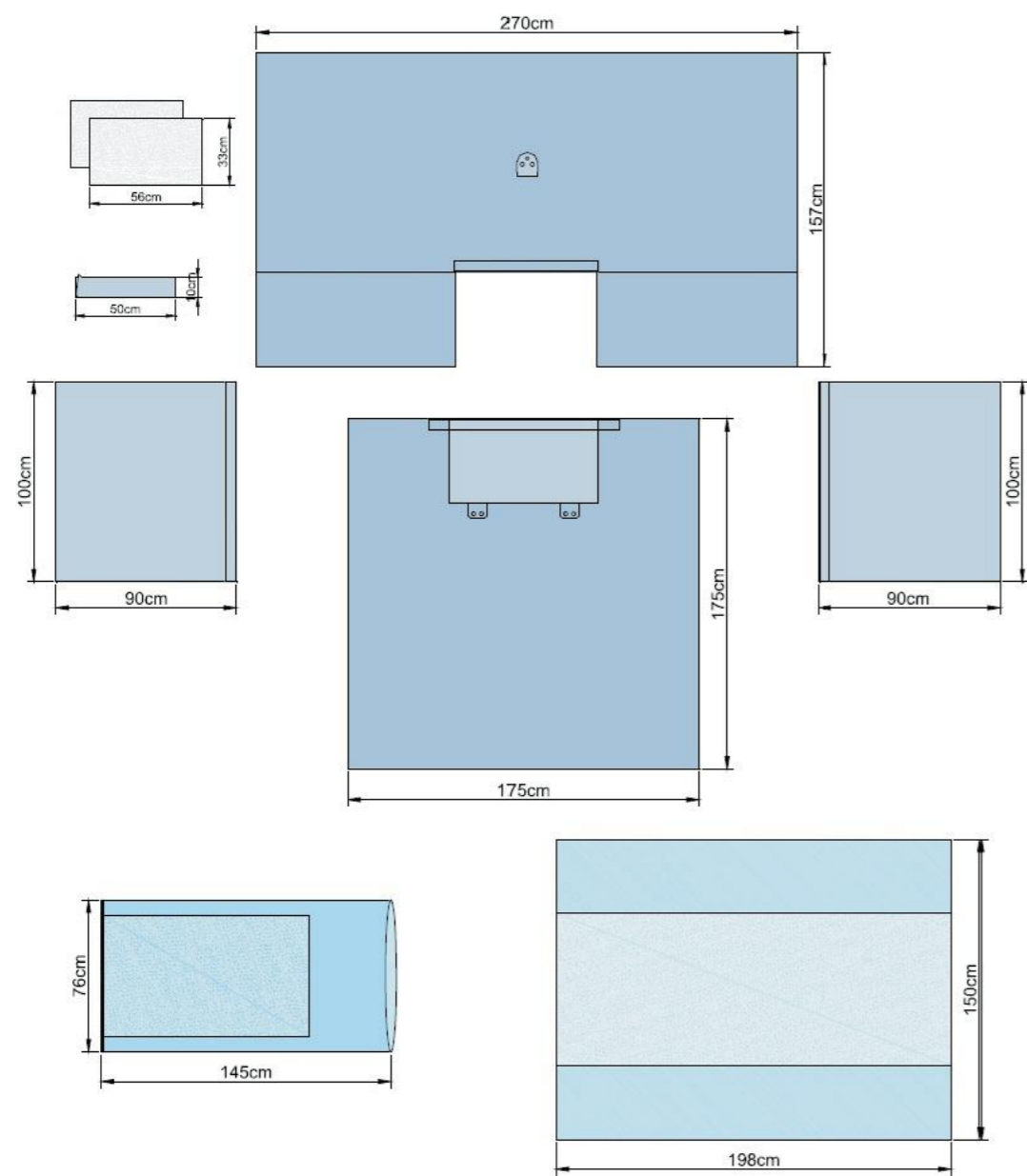

PM1334 Universal Paediatric Pack

Part No.	Description	Size	Unit	Qty.
PM6105	Top Drape	180x240cm	Each	1
PM6302	Side Drape	100x90cm	Each	2
PM6203	Bottom Drape	180x180cm	Each	1
PM3114	Back Table Cover	150x190cm	Each	1
PM3202	Mayo Stand Cover	76x145cm	Each	1
PM4042	Tape Strip	10x50cm	Each	1
PM4000	Hand Towel	56x33cm	Each	2

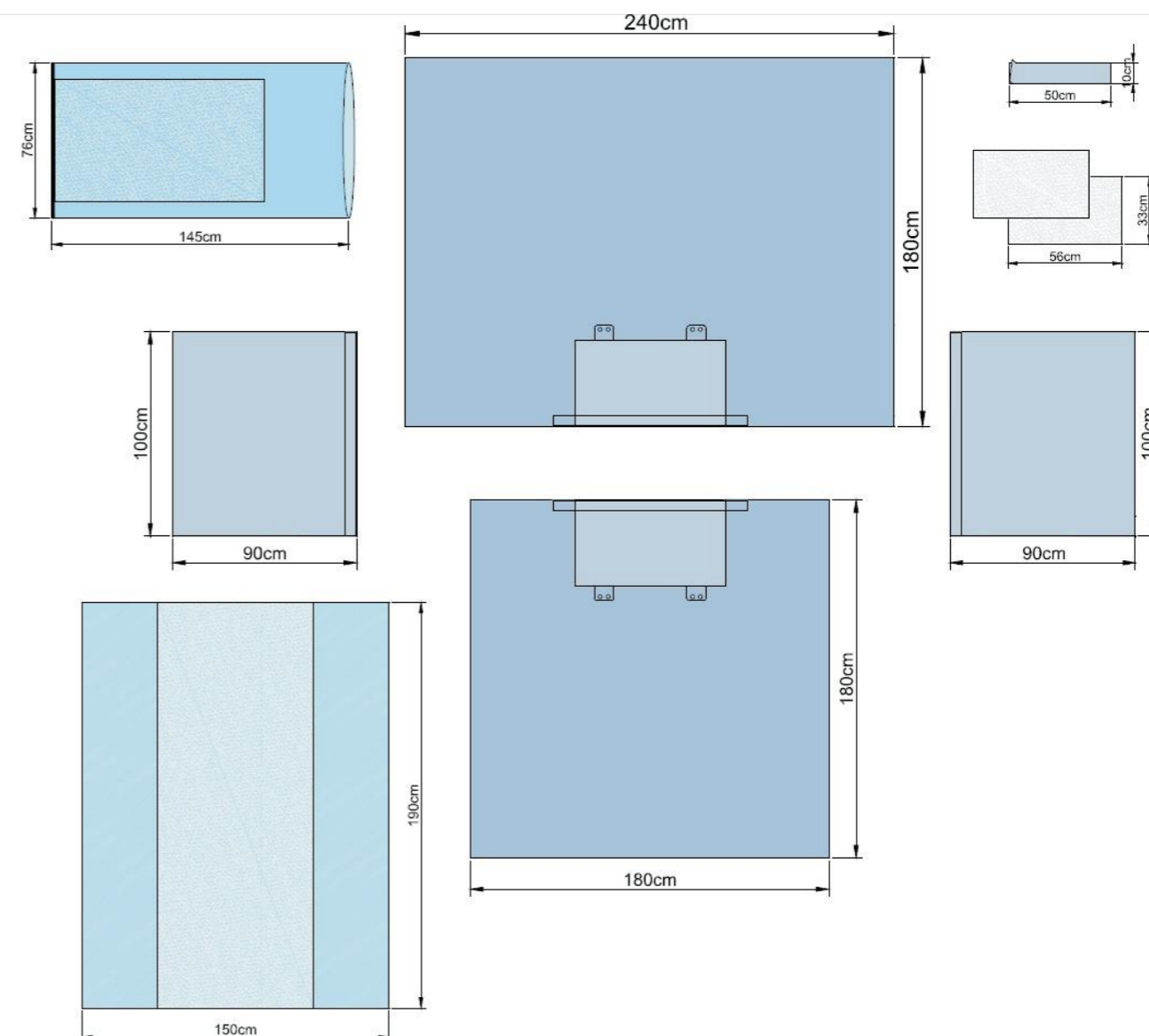

PM1301 Shoulder Pack

Part No.	Description	Size	Unit	Qty.
PM3201	Mayo Stand Cover	58x137cm	Each	1
PM4041	Suture Bag	16x28cm	Each	1
PM4000	Hand Towel	56x33cm	Each	1
PM6571	Utility Drape	38x66cm	Each	4
PM5304	Standard SMS Gown, XL-XLong	XL-XLong	Each	1
PM5101W	Standard SMS Gown with Towel in Wrap, Large	Large	Each	1
PM6452	Body Split Drape	196X295cm	Each	1
PM2024	Shoulder Drape	254x157cm	Each	1
PM3102	Back Table Cover	112x229cm	Each	1

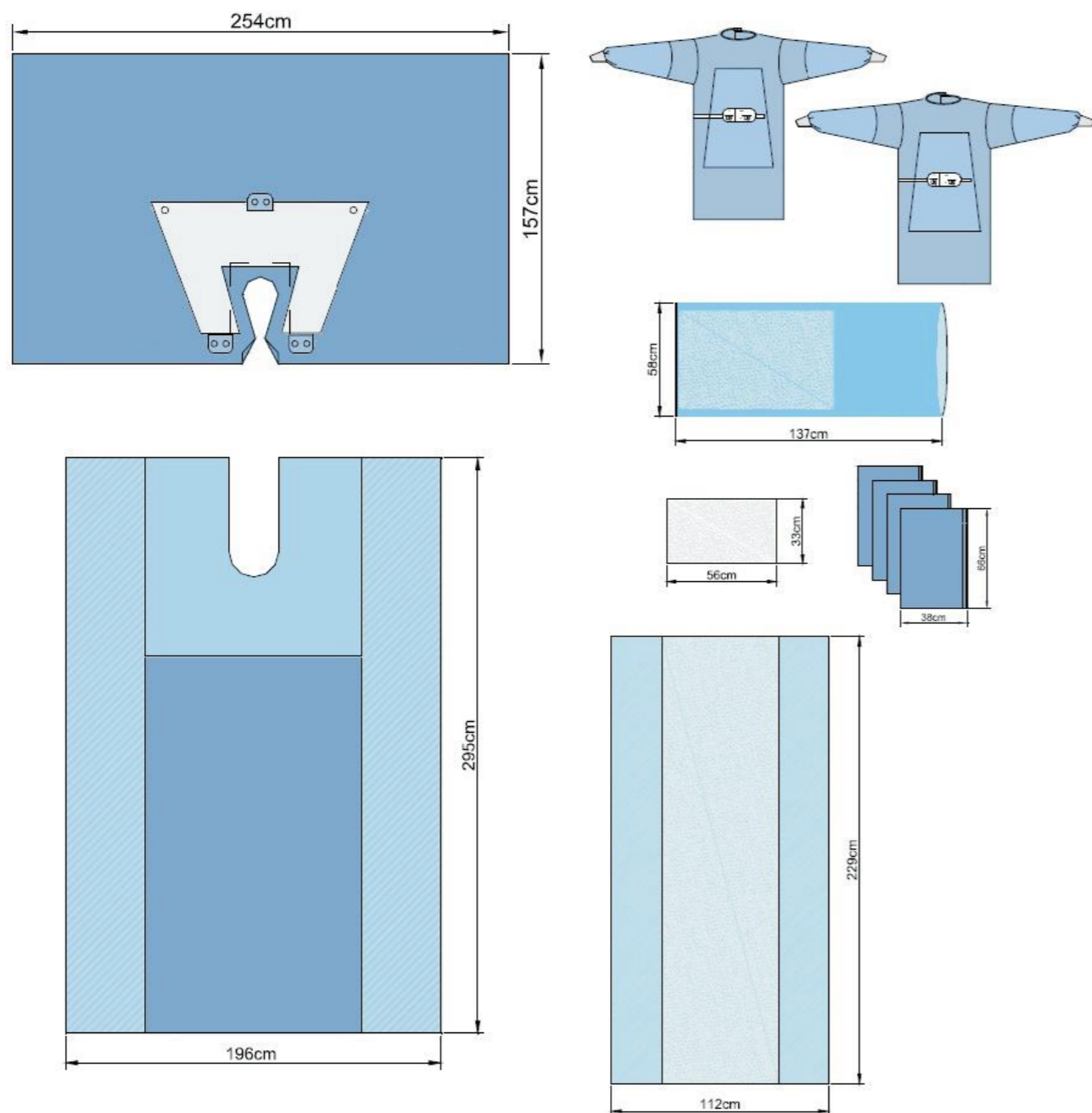

PM1302 Arthroscopy Pack I

Part No.	Description	Size	Unit	Qty.
PM3201	Mayo Stand Cover	58x137cm	Each	1
PM4041	Suture Bag	16x28cm	Each	1
PM5304	Standard SMS Gown, XL-XLong	XL-XLong	Each	1
PM5101W	Standard SMS Gown with Towel in Wrap, Large	Large	Each	1
PM3301	Stockinette	23x122cm	Each	1
PM4042	Tape Strip	10x50cm	Each	4
PM6471	Poly U Drape	152X178cm	Each	2
PM6805	Arthroscopy Drape	230x305cm	Each	1
PM3103	Back Table Cover	127x229cm	Each	1

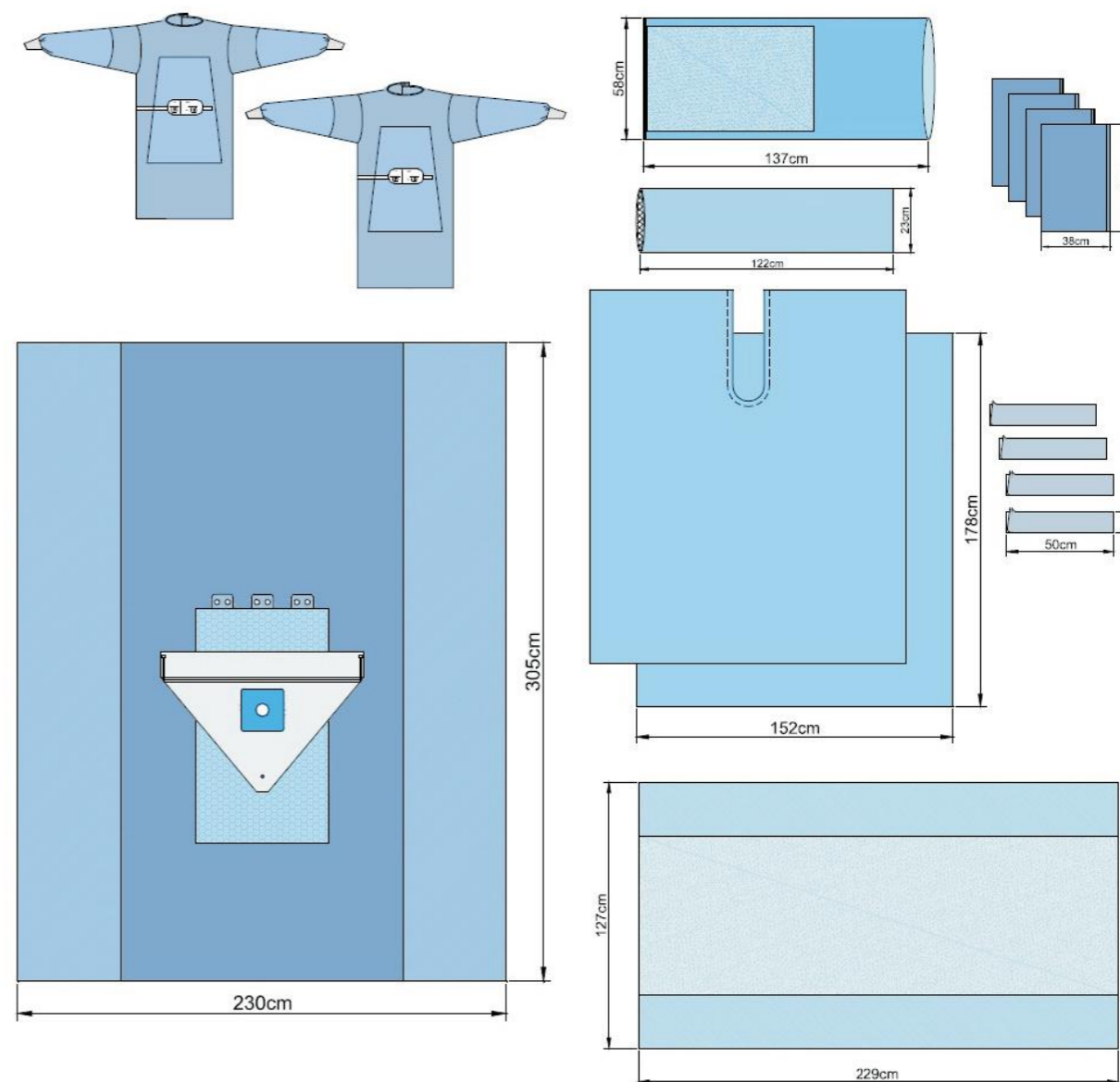

PM1303 Arthroscopy Pack II

Part No.	Description	Size	Unit	Qty.
PM3201	Mayo Stand Cover	58x137cm	Each	1
PM4041	Suture Bag	16x28cm	Each	1
PM4000	Hand Towel	56x33cm	Each	1
PM5204	Poly Reinf SMS Gown, X-Large	X-Large	Each	1
PM6471	Poly U Drape	152x178cm	Each	1
PM3301	Stockinette	23x122cm	Each	1
PM6801	Extremity Sheet	220x318cm	Each	1
PM3103	Back Table Cover	127x229cm	Each	1

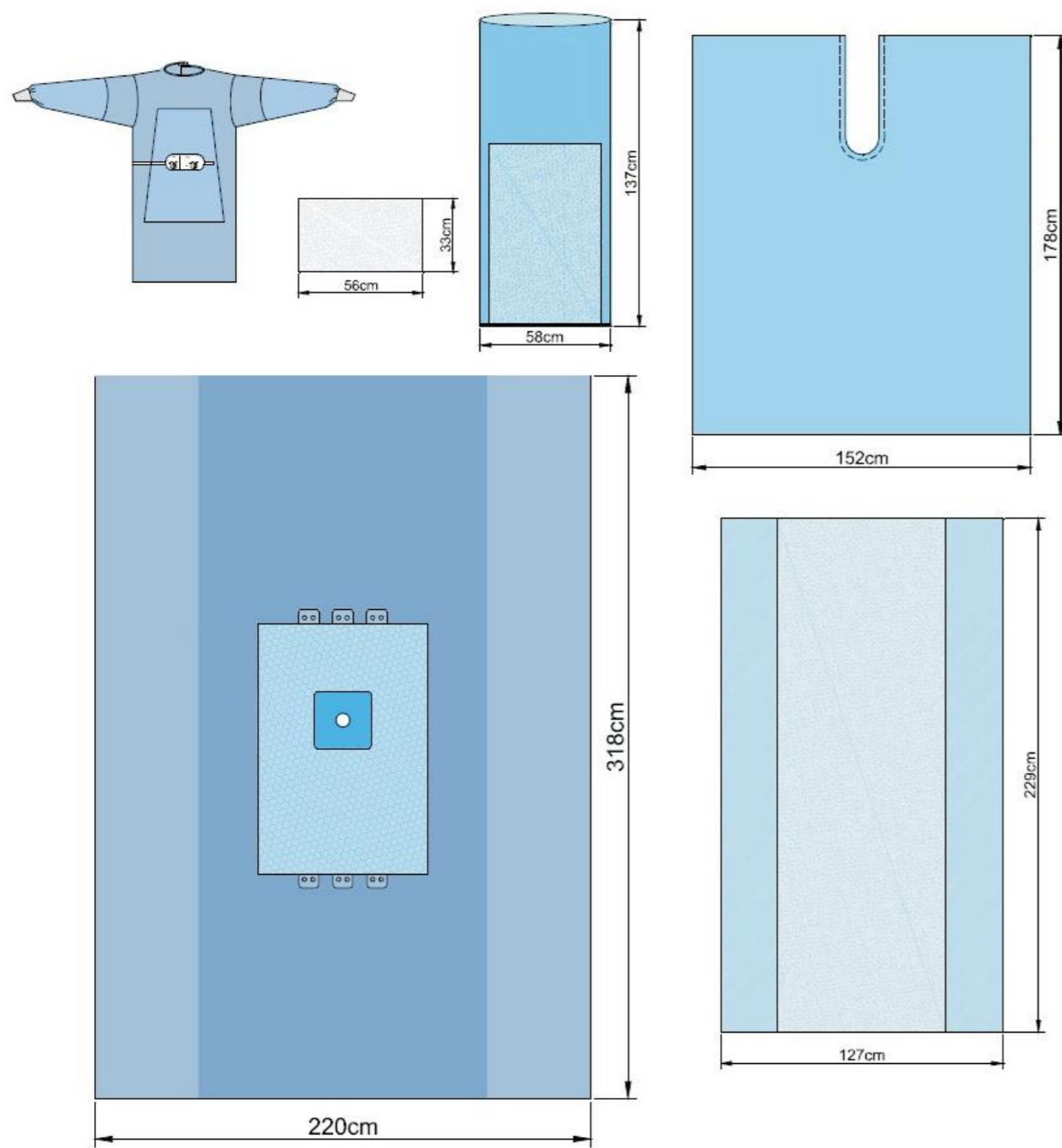

PM1304 Arthroscopy Pack III

Part No.	Description	Size	Unit	Qty.
PM3201	Mayo Stand Cover	58x137cm	Each	1
PM4000	Hand Towel	56x33cm	Each	2
PM4041	Suture Bag	16x28cm	Each	1
PM3301	Stockinette	23x122cm	Each	1
PM5304	Standard SMS Gown, XL-XLong	XL-XLong	Each	2
PM5101W	Standard SMS Gown with Towel in Wrap, Large	Large	Each	1
PM6471	Poly U Drape	152x178cm	Each	2
PM4042	Tape Strip	10x50cm	Each	4
PM4051	Arthroscopy Sheet	230x305cm	Each	1
PM3103	Back Table Cover	127x229cm	Each	1

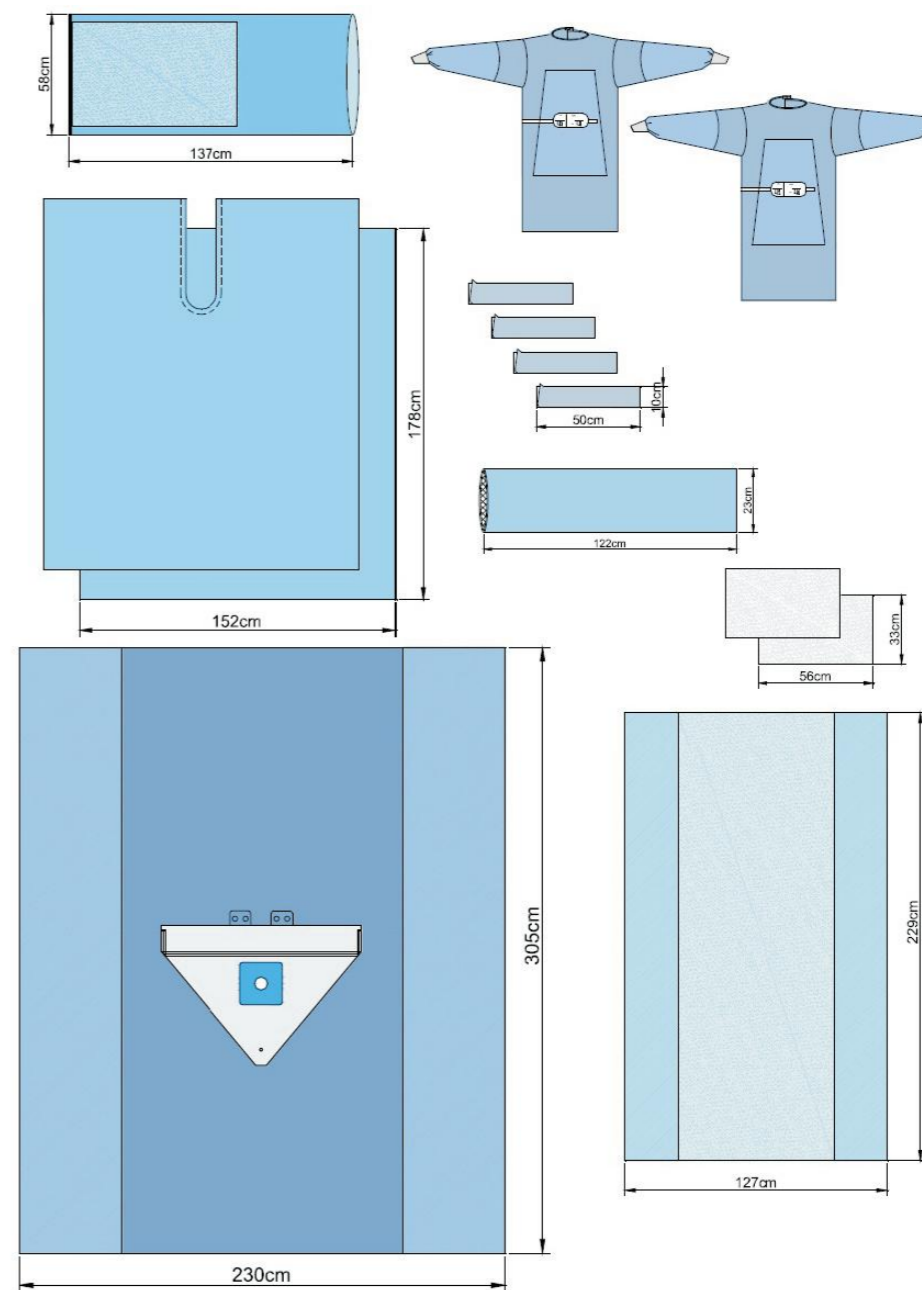

PM1349 Arthroscopy Pack IV

Part No.	Description	Size	Unit	Qty.
PM4075	Arthroscopy Drape	220x320cm	Each	1
PM6515	Drape	150x140cm	Each	1
PM3302	Stockinette	30.5x122cm	Each	1
PM3106	Back Table Cover	150x200cm	Each	1
PM3202	Mayo Stand Cover	76x145cm	Each	1
PM4042	Tape Strip	10x50cm	Each	1
PM4000	Hand Towel	56x33cm	Each	2

PM1010 Shoulder Arthroscopy Pack

Part No.	Description	Size	Unit	Qty.
PM2024	Shoulder Drape	254x157cm	Each	1
PM6404	Body Split Drape	196x295cm	Each	1
PM3102	Back Table Cover	112x229cm	Each	1

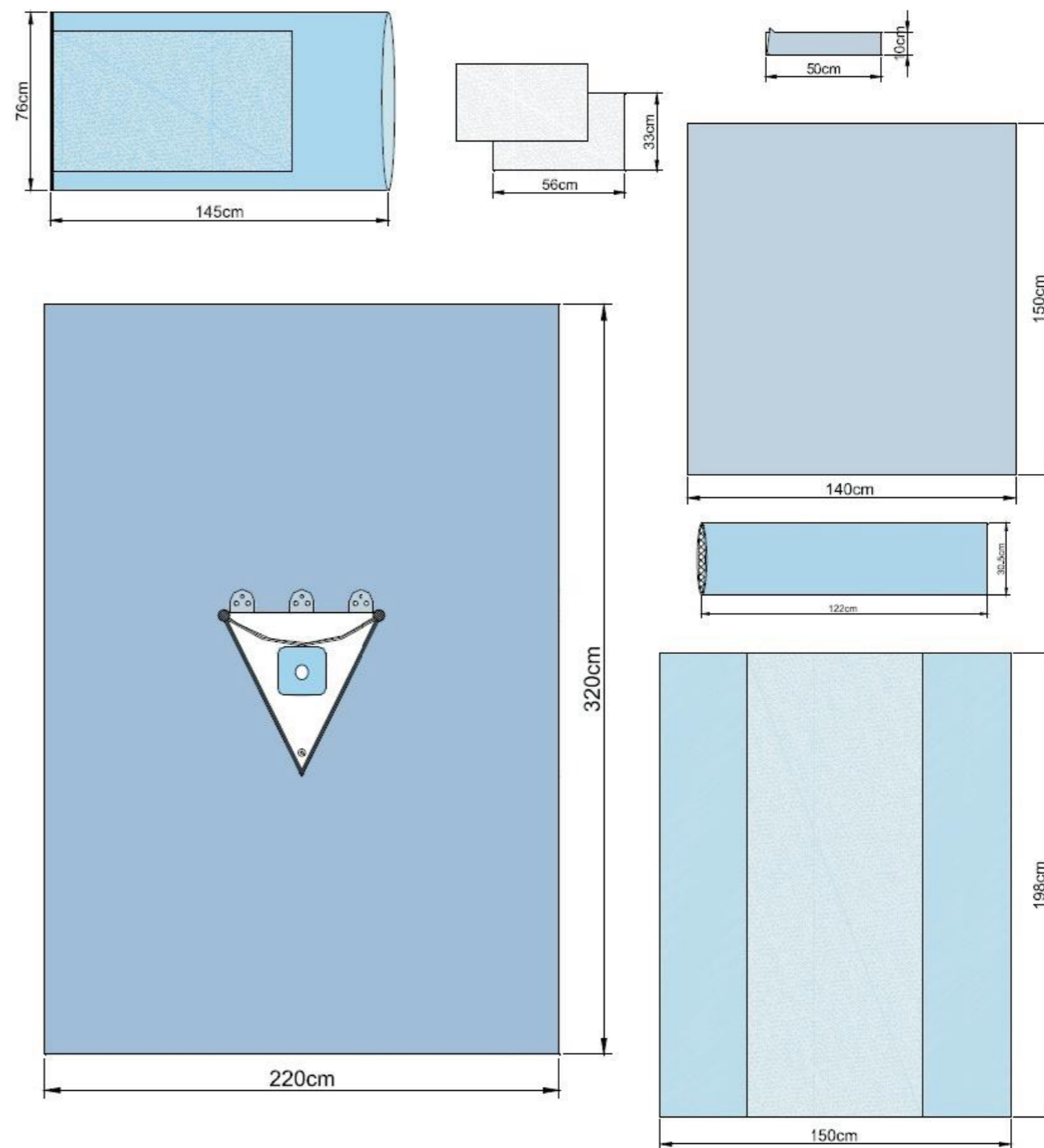
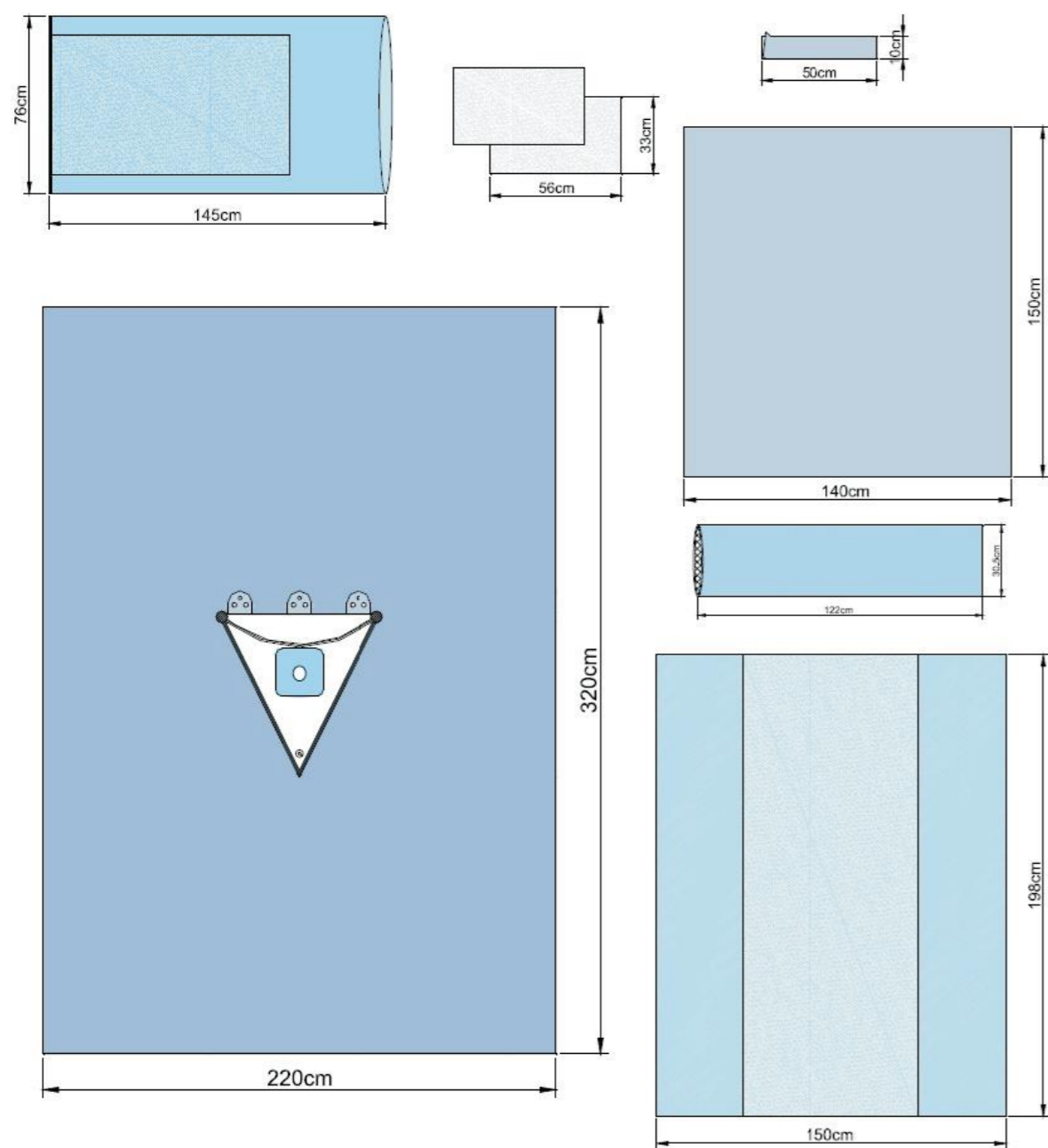

PM1306 Head & Neck Pack I

Part No.	Description	Size	Unit	Qty.
PM3201	Mayo Stand Cover	58x137cm	Each	1
PM4041	Suture Bag	16x28cm	Each	1
PM5101	Standard SMS Gown, Large	Large	Each	1
PM6571	Utility Drape	38x66cm	Each	2
PM4060	Bar Drape	104x90cm	Each	1
PM6405	Split Drape	196x292cm	Each	1
PM3102	Back Table Cover	112x229cm	Each	1

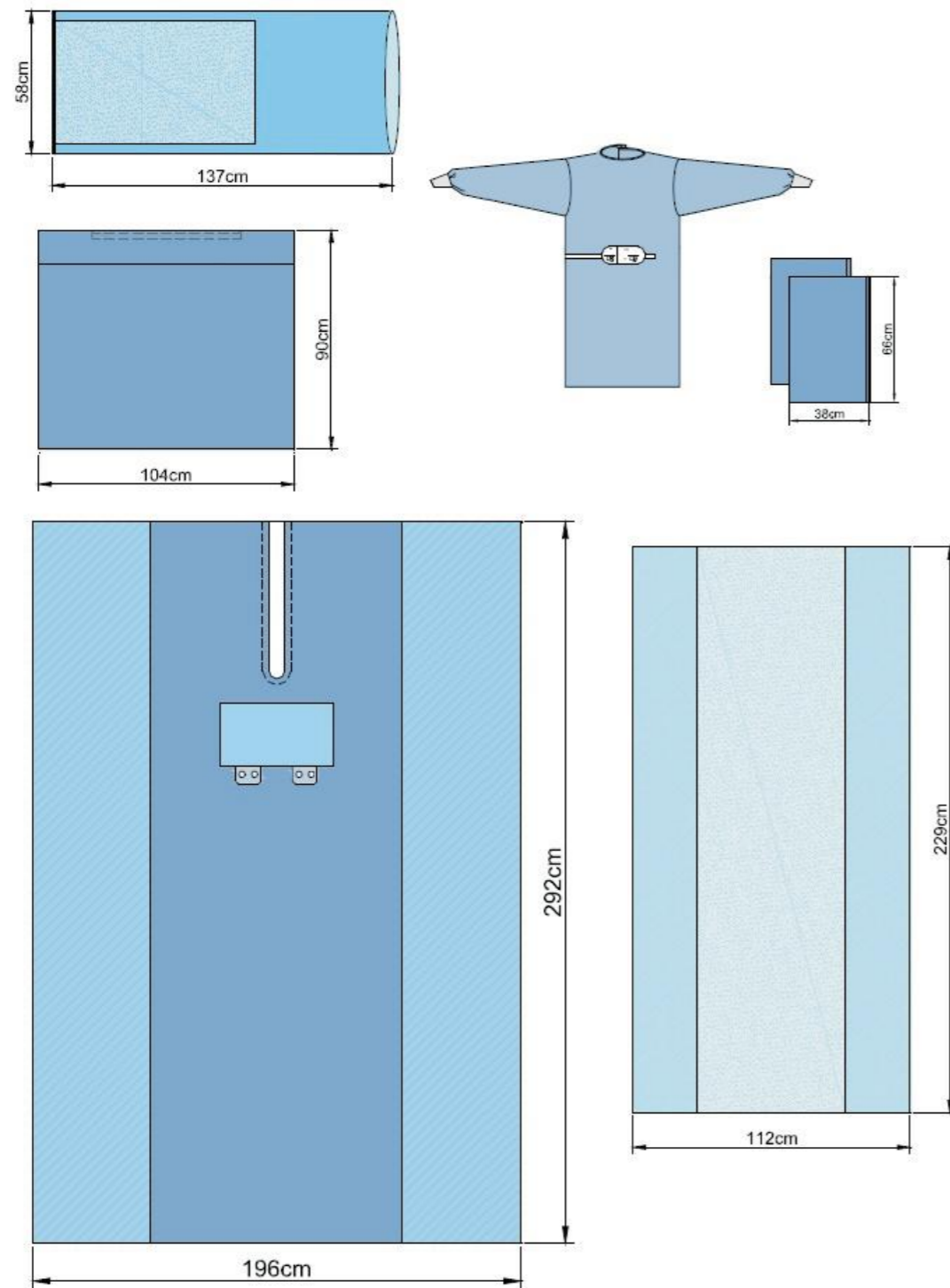

PM1307 Cystoscopy Pack I

Part No.	Description	Size	Unit	Qty.
PM4000	Hand Towel	56x33cm	Each	1
PM3402	SMS Leggings	80x120cm	Each	2
PM6702	Cystoscopy T Drape	152x208cm	Each	1
PM3101	Back Table Cover	112x190cm	Each	1

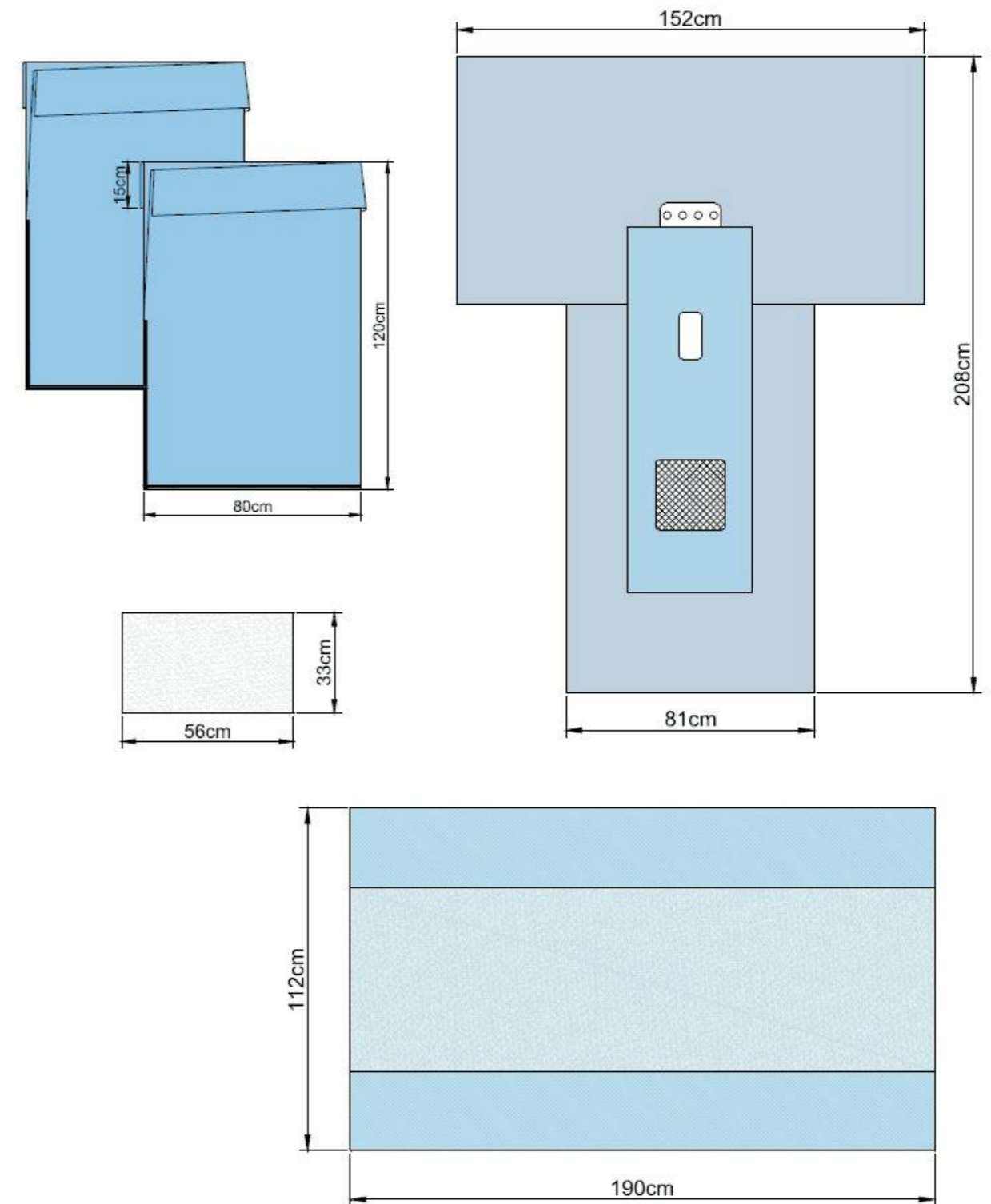

PM1308 Cystoscopy Pack II

Part No.	Description	Size	Unit	Qty.
PM4000	Hand Towel	56x33cm	Each	1
PM5304	Standard SMS Gown, XL-XLong	XL-XLong	Each	1
PM3402	SMS Leggings	80x120cm	Each	2
PM4041	Suture Bag	16x28cm	Each	1
PM6703	Cystoscopy T Drape	162x231cm	Each	1
PM3102	Back Table Cover	112x229cm	Each	1

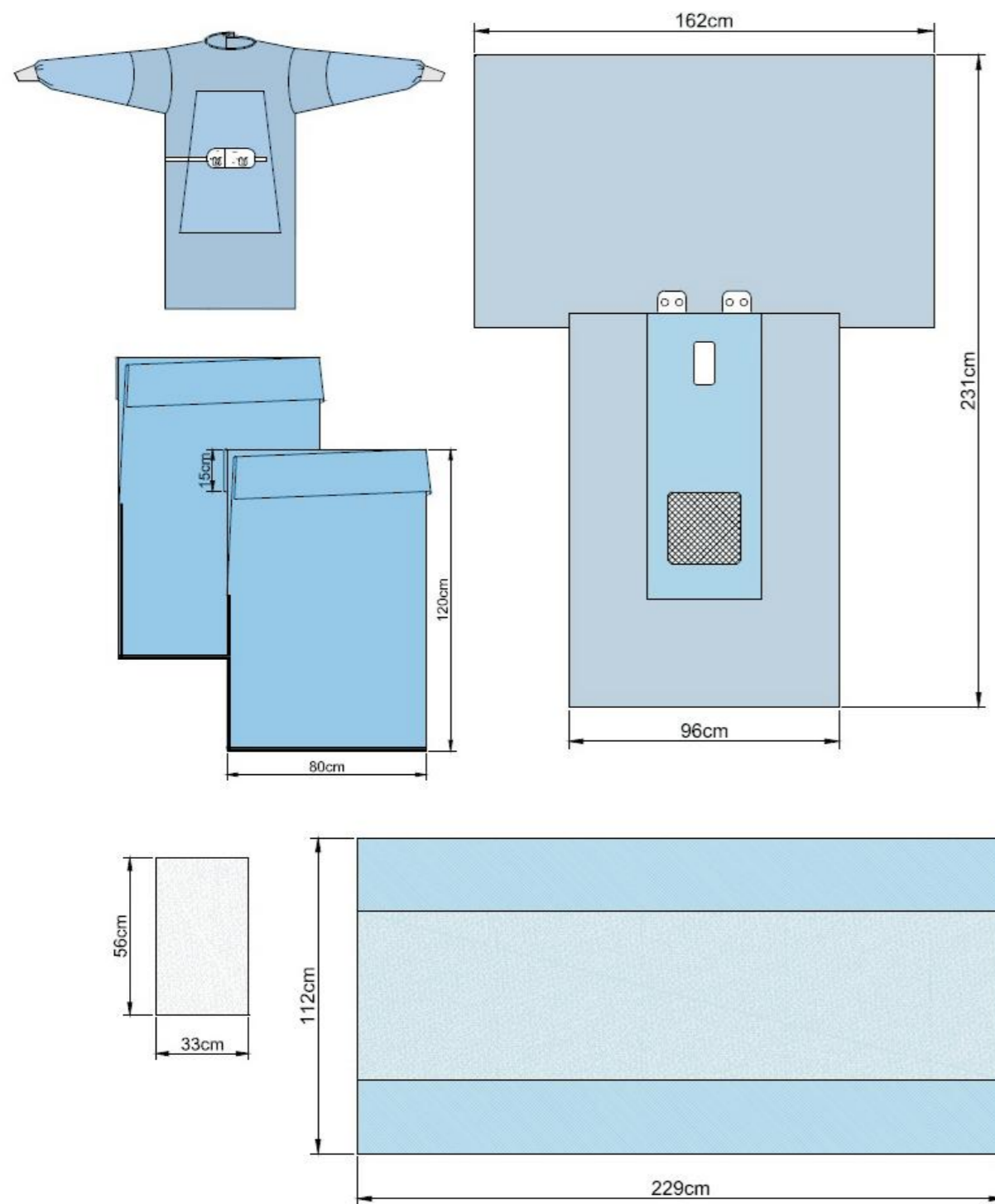

PM1009 Cystoscopy Pack III

Part No.	Description	Size	Unit	Qty.
PM4041	Suture Bag	16x28cm	Each	1
PM4000	Hand Towel	56x33cm	Each	1
PM6701	Cysto Sheet	264x218cm	Each	1
PM3101	Back Table Cover	112x190cm	Each	1

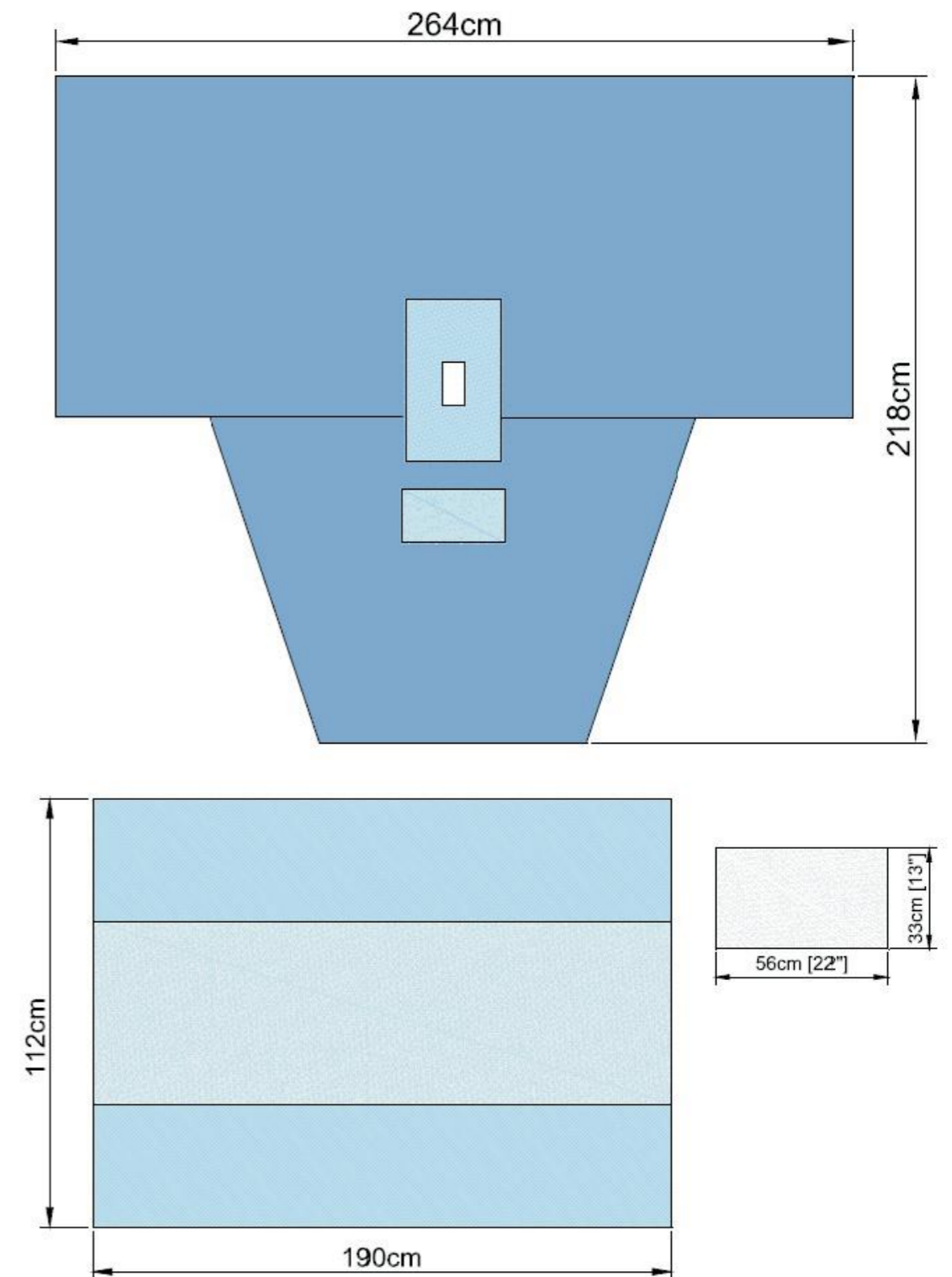

PM1309 Laparotomy Pack I

Part No.	Description	Size	Unit	Qty.
PM3201	Mayo Stand Cover	58x137cm	Each	1
PM4000	Hand Towel	56x33cm	Each	1
PM4041	Suture Bag	16x28cm	Each	1
PM6571	Utility Drape	38x66cm	Each	4
PM6604	Laparotomy Sheet	262x310cm	Each	1
PM3102	Back Table Cover	112x229cm	Each	1

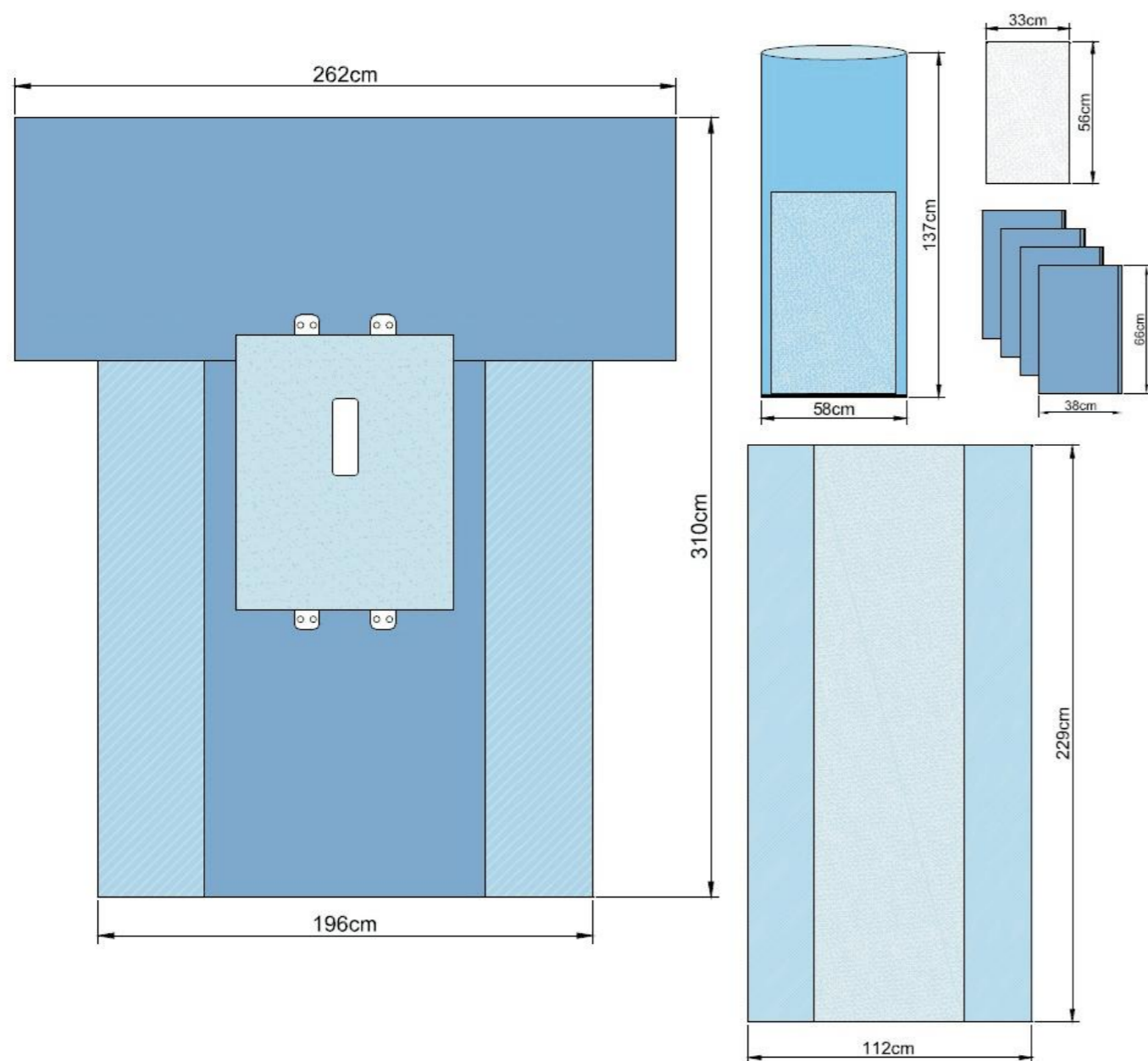

PM1310 Laparotomy Pack II

Part No.	Description	Size	Unit	Qty.
PM3201	Mayo Stand Cover	58x137cm	Each	1
PM4041	Suture Bag	16x28cm	Each	1
PM4000	Hand Towel	56x33cm	Each	1
PM6571S	Utility Drape	38x66cm	Each	4
PM6601	Laparotomy Sheet	254x305cm	Each	1
PM3102	Back Table Cover	112x229cm	Each	1

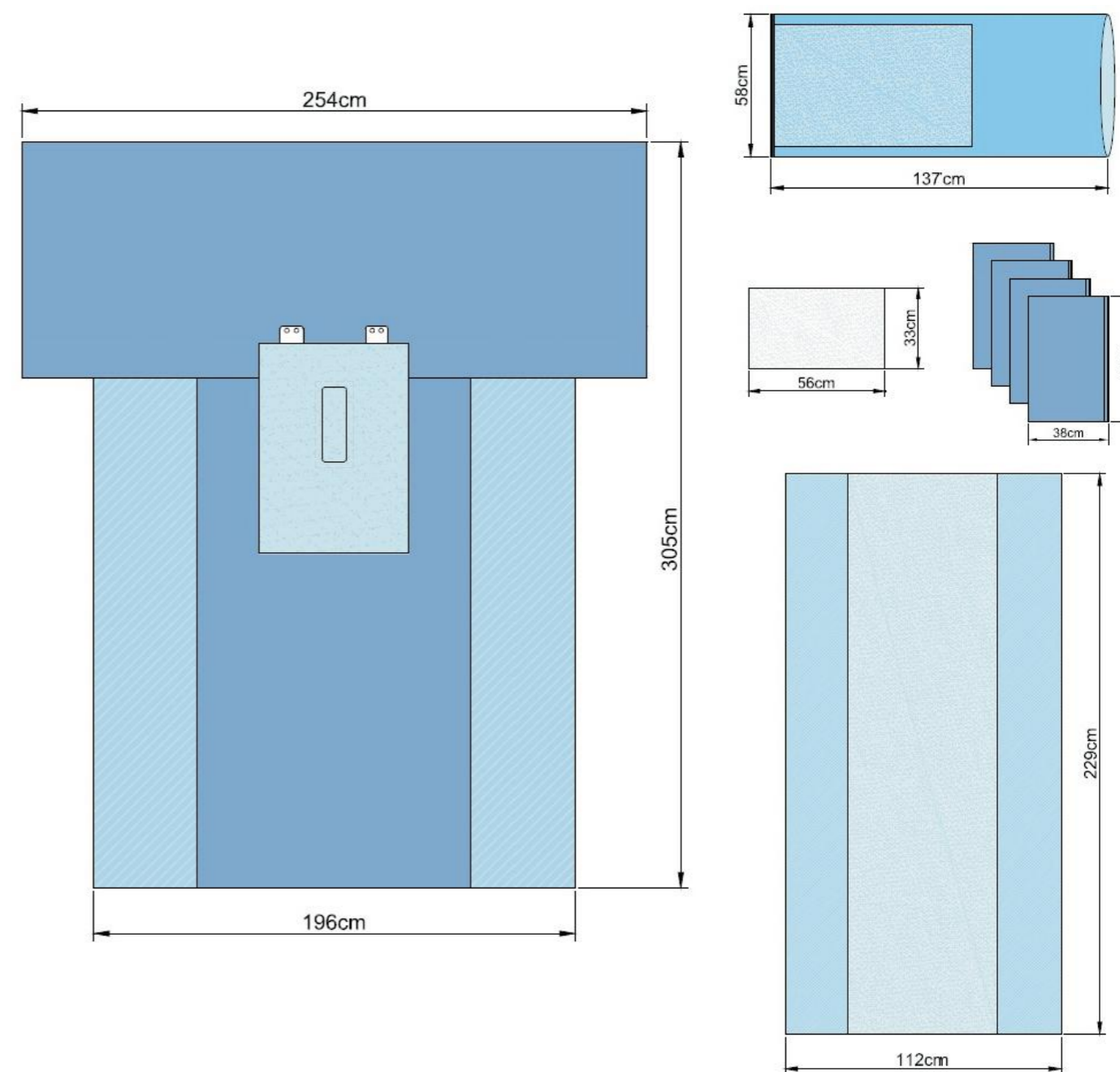

PM1311 Laparoscopy Pack III

Part No.	Description	Size	Unit	Qty.
PM6901	Under Buttocks Drape	77X115cm	Each	1
PM3402	SMS Leggings	80x120cm	Each	2
PM4000	Hand Towel	56x33cm	Each	1
PM6671	Laparoscopy T Drape	244x250cm	Each	1
PM3102	Back Table Cover	112x229cm	Each	1

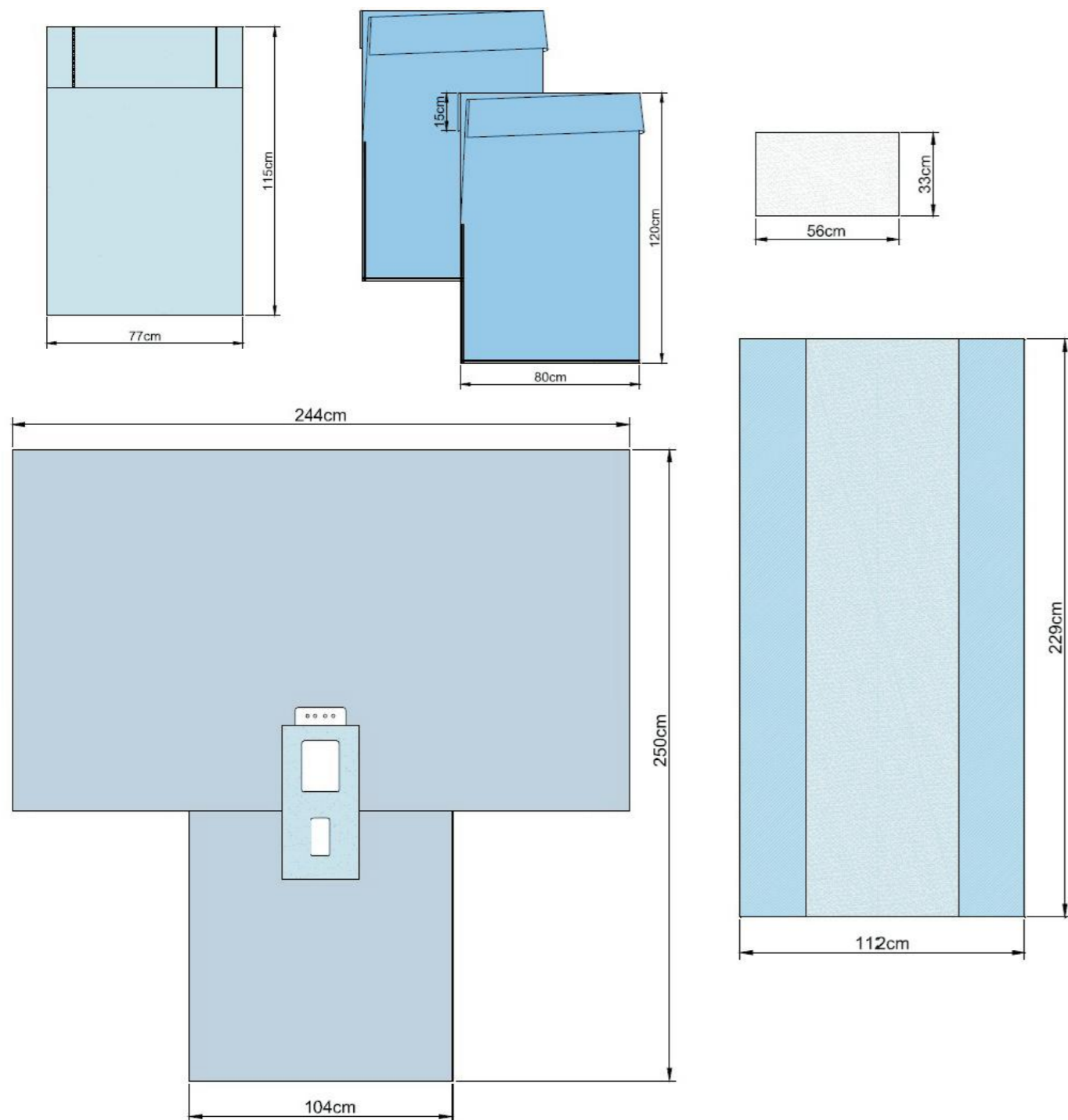

PM1312 Laparotomy Pack IV

Part No.	Description	Size	Unit	Qty.
PM3201	Mayo Stand Cover	58x137cm	Each	1
PM4041	Suture Bag	16x28cm	Each	1
PM4000	Hand Towel	56x33cm	Each	1
PM6571S	Utility Drape	38x66cm	Each	4
PM6501	Half Drape	106x145cm	Each	2
PM6603	Laparotomy Sheet	196x305cm	Each	1
PM3102	Back Table Cover	112x229cm	Each	1

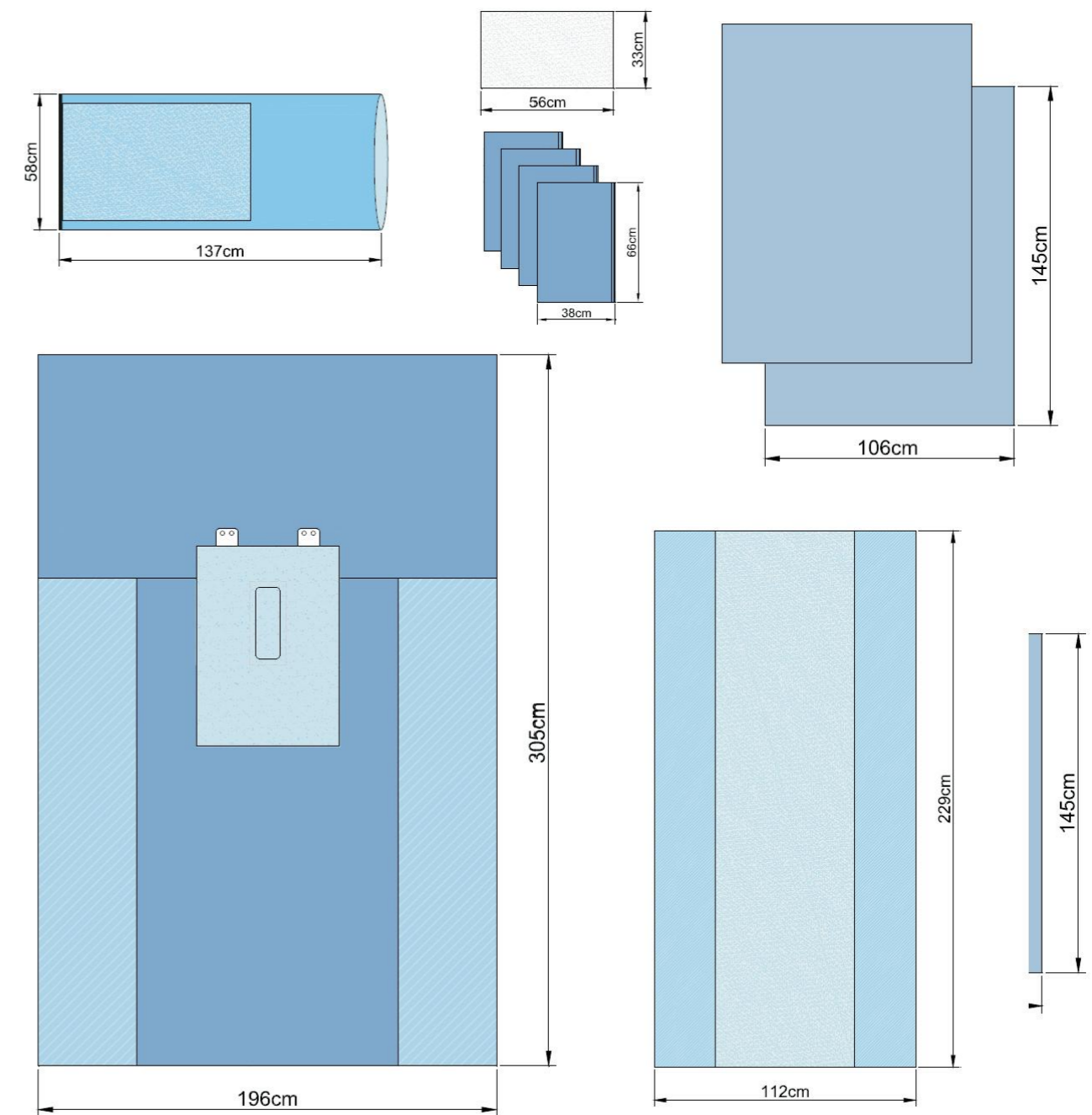

PM1314 Laparotomy Pack V

Part No.	Description	Size	Unit	Qty.
PM3201	Mayo Stand Cover	58x137cm	Each	1
PM4000	Hand Towel	56x33cm	Each	1
PM4041	Suture Bag	16x28cm	Each	1
PM5104	Poly Reinf SMS Gown, Large	Large	Each	1
PM5104W	Poly Reinf SMS Gown, with Towel in Wrap, Large	Large	Each	1
PM6571S	Utility Drape	38x66cm	Each	4
PM6601	Laparotomy Sheet	254x305cm	Each	1
PM3103	Back Table Cover	127x229cm	Each	1

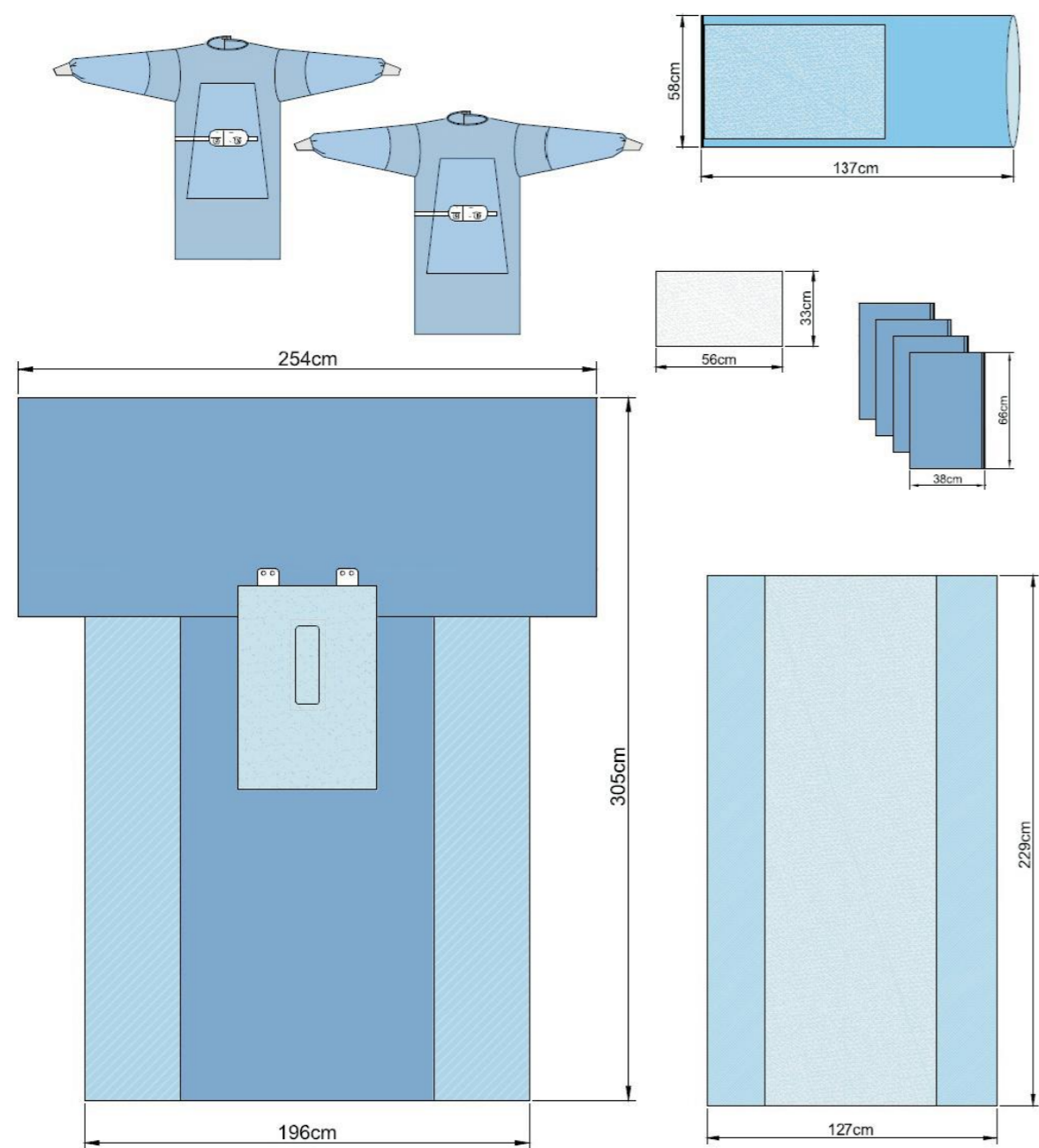

PM1315 Laparotomy Pack VI

Part No.	Description	Size	Unit	Qty.
PM3201	Mayo Stand Cover	58x137cm	Each	1
PM4041	Suture Bag	16x28cm	Each	1
PM5107W	Fab Reinf SMS Gown with Towel in Wrap, Large	Large	Each	2
PM6571S	Utility Drape	38x66cm	Each	4
PM6601	Laparotomy Sheet	254x305cm	Each	1
PM3102	Back Table Cover	112x229cm	Each	1

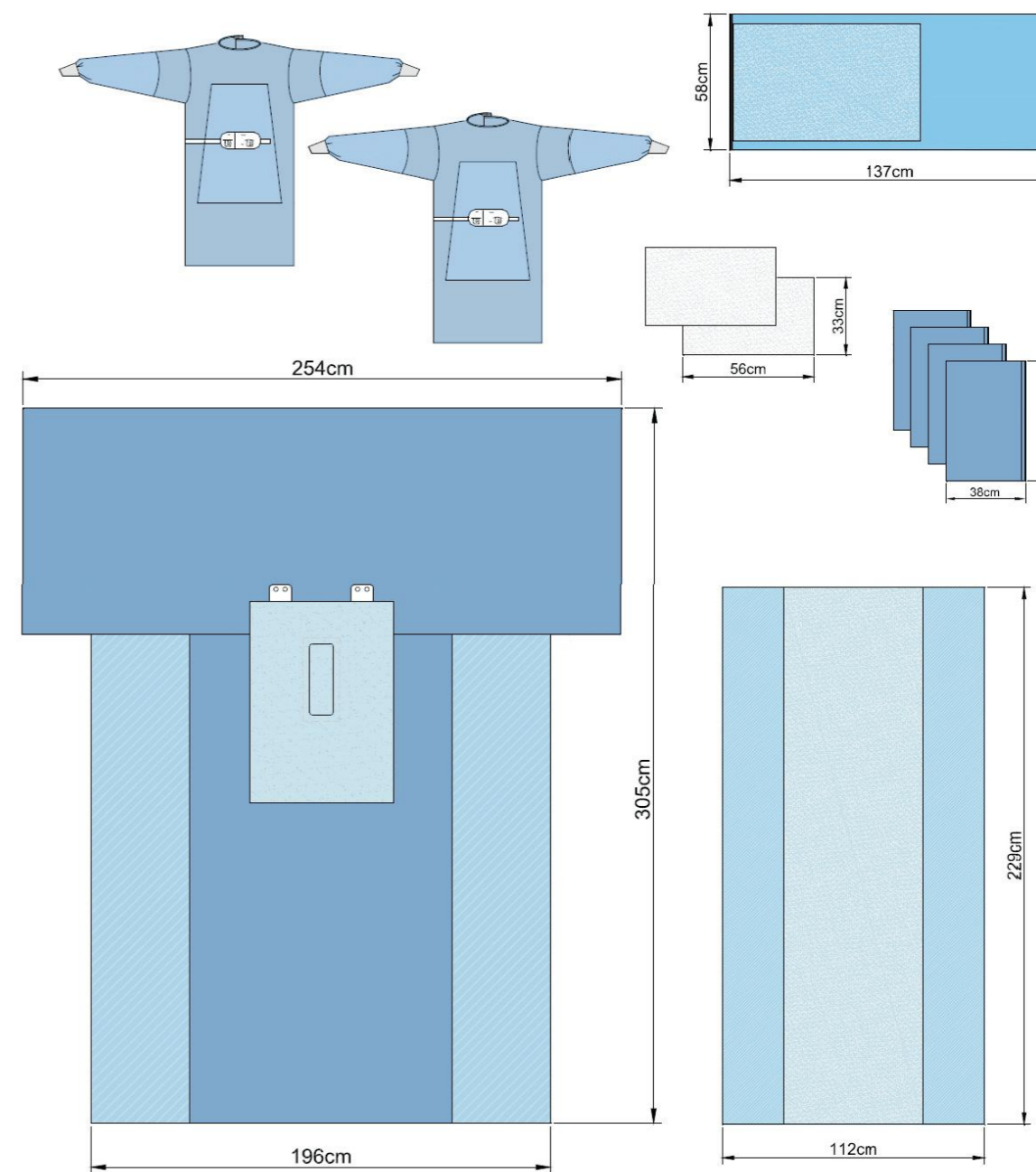

PM1335 Laparotomy Pack VII

Part No.	Description	Size	Unit	Qty.
PM5107W	Fab Reinf SMS Gown with Towel in Wrap, Large	Large	Each	1
PM5107	Fab Reinf SMS Gown, Large	Large	Each	1
PM3201	Mayo Stand Cover	58x137cm	Each	1
PM4041	Suture Bag	16x28cm	Each	1
PM4000	Hand Towel	56x33cm	Each	4
PM6601	Laparotomy Sheet	254x305cm	Each	1
PM3102	Back Table Cover	112x229cm	Each	1

PM1318 TransverseLaparotomy Pack

Part No.	Description	Size	Unit	Qty.
PM5101W	Standard SMS Gown with Towel in Wrap, Large	Large	Each	1
PM3201	Mayo Stand Cover	58x137cm	Each	1
PM4000	Hand Towel	56x33cm	Each	1
PM5101	Standard SMS Gown, Large	Large	Each	1
PM4041	Suture Bag	16x28cm	Each	1
PM6571	Utility Drape	38x66cm	Each	4
PM6602	Laparotomy Sheet	267x353cm	Each	1
PM3102	Back Table Cover	112x229cm	Each	1

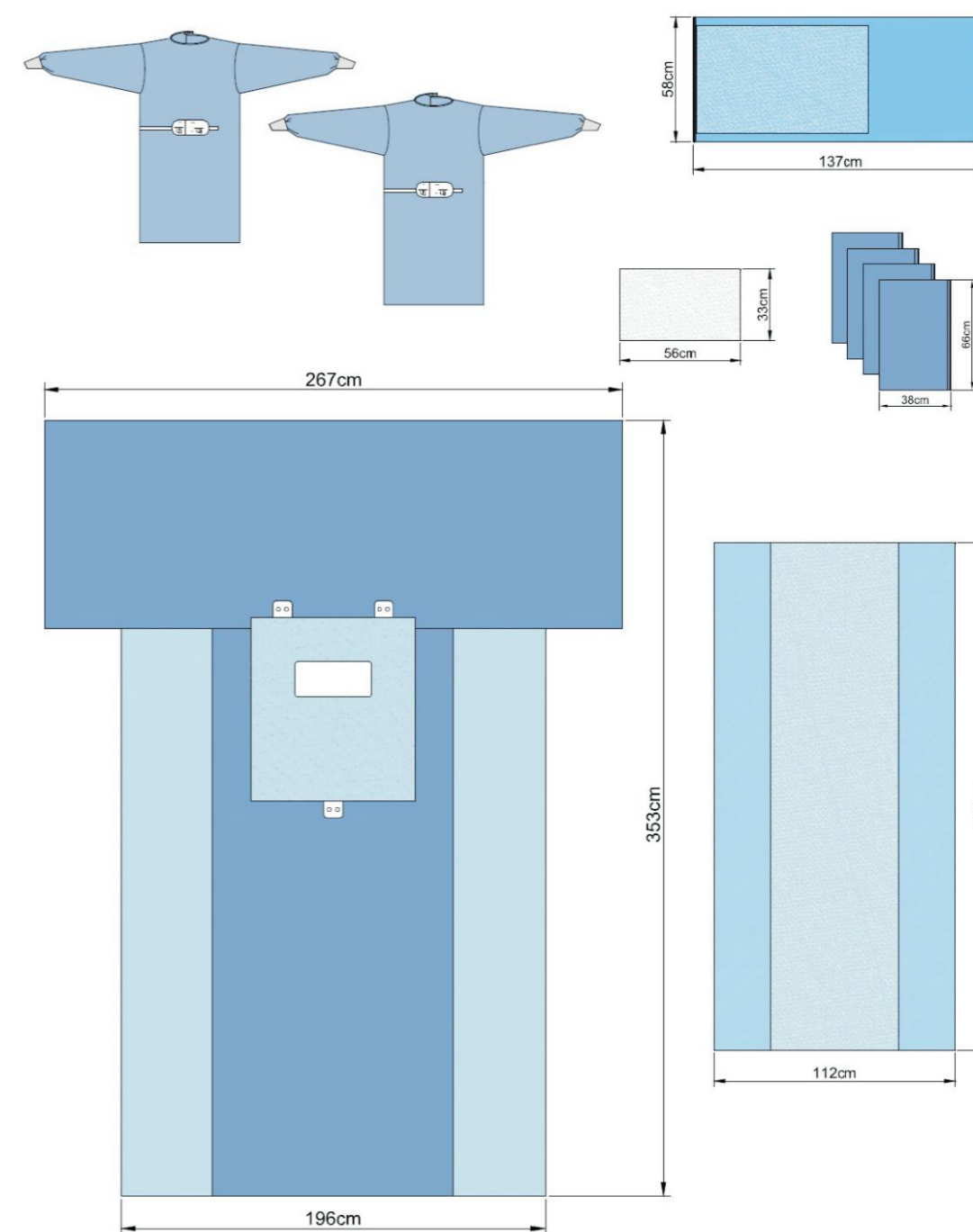
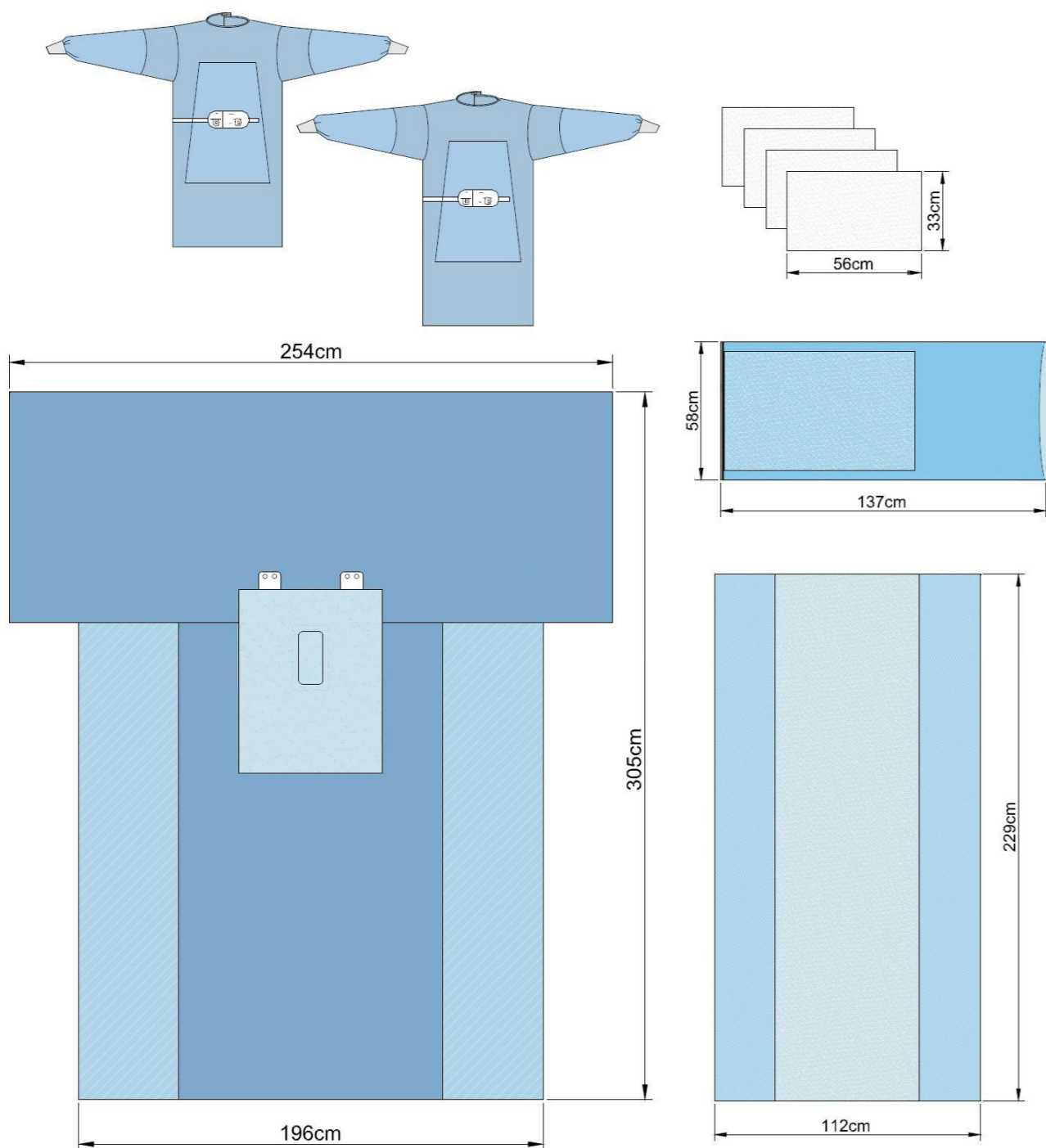

PM1343 Orthopedic Pack I

Part No.	Description	Size	Unit	Qty.
PM6502	Three Quarter Drape	145x160cm	Each	1
PM6402	Split Drape	196x251cm	Each	1
PM4041	Suture Bag	16x28cm	Each	1
PM3201	Mayo Stand Cover	58x137cm	Each	1
PM6471	Poly U Drape	152x178cm	Each	1
PM6571S	Utility Drape	38x66cm	Each	4
PM3103	Back Table Cover	127x229cm	Each	1

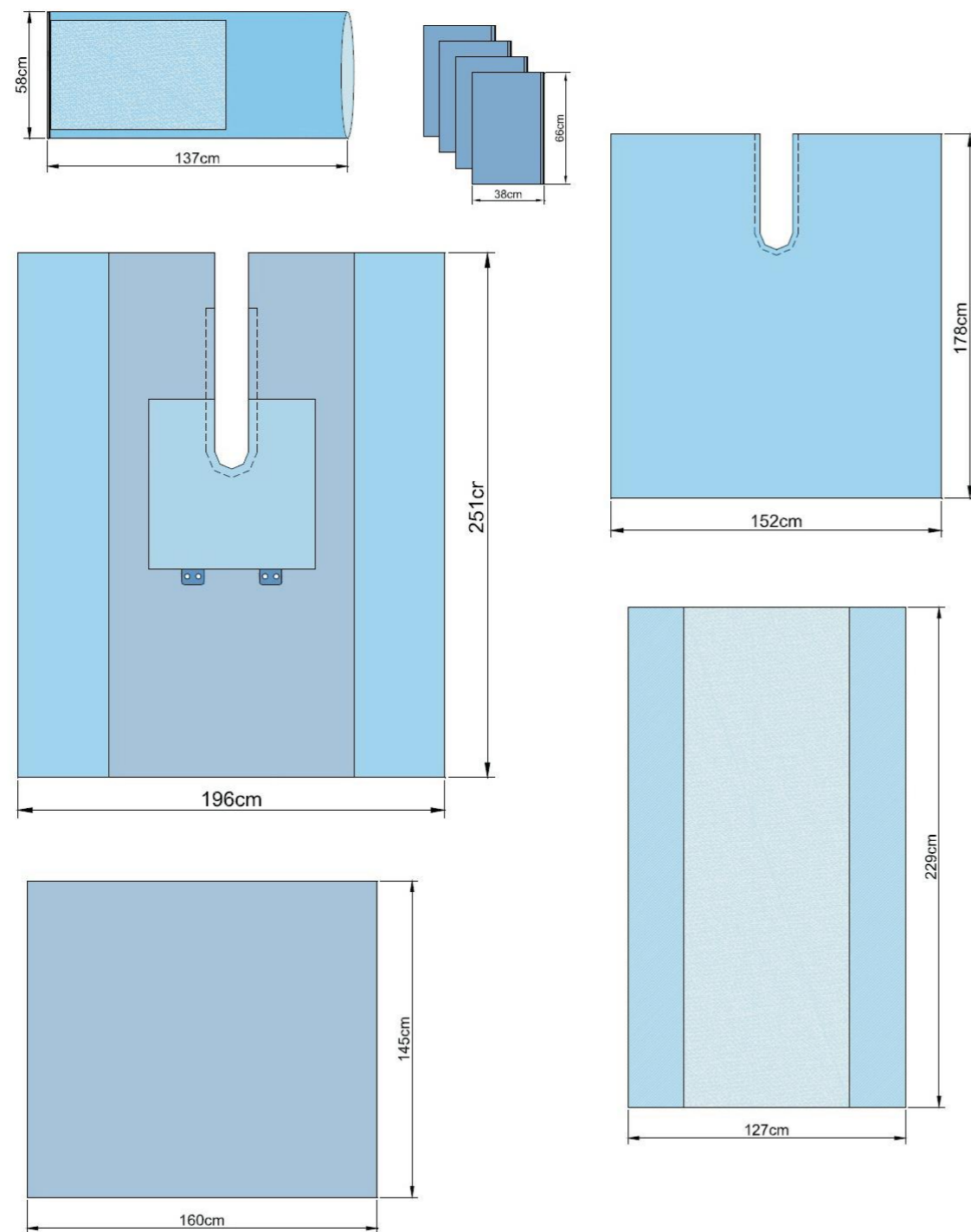

PM1344 Orthopedic Pack II

Part No.	Description	Size	Unit	Qty.
PM6502	Three Quarter Drape	145x160cm	Each	1
PM4000	Hand Towel	56x33cm	Each	1
PM4041	Suture Bag	16x28cm	Each	1
PM3201	Mayo Stand Cover	58x137cm	Each	1
PM3101	Back Table Cover	112x190cm	Each	1
PM6571S	Utility Drape	38x66cm	Each	4
PM3103	Back Table Cover	127x229cm	Each	1

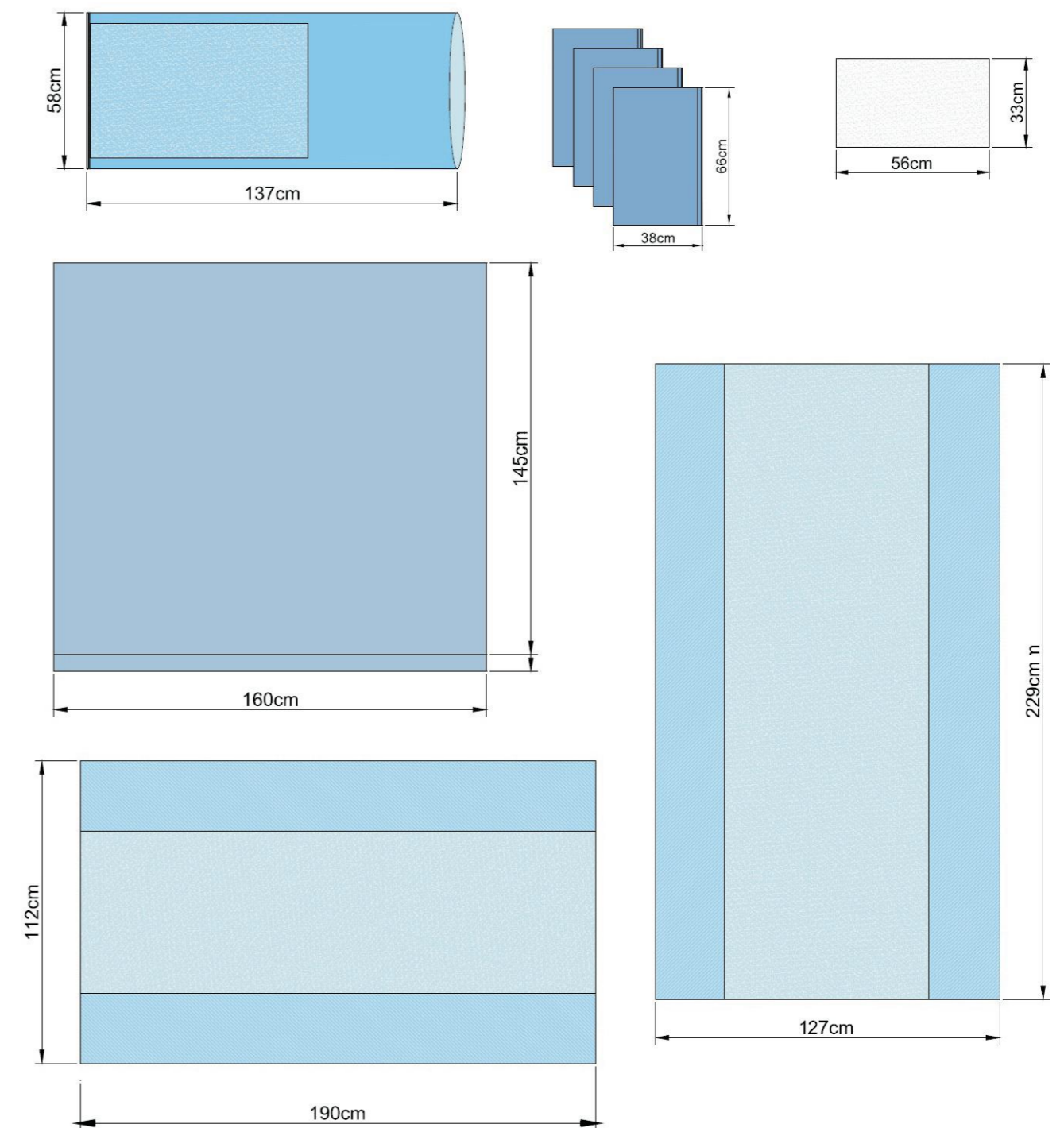

PM1345 Orthopedic Pack III

Part No.	Description	Size	Unit	Qty.
PM6502	Three Quarter Drape	145x160cm	Each	1
PM6412	Split Drape 77"x108"	195.5x274cm	Each	1
PM5204	Poly Reinf SMS Gown, X-Large	X-Large	Each	2
PM4000	Hand Towel	56x33cm	Each	2
PM4041	Suture Bag	16x28cm	Each	1
PM3201	Mayo Stand Cover	58x137cm	Each	1
PM6471	Poly U Drape	152x178cm	Each	1
PM6571S	Utility Drape	38x66cm	Each	4
PM3103	Back Table Cover	127x229cm	Each	1

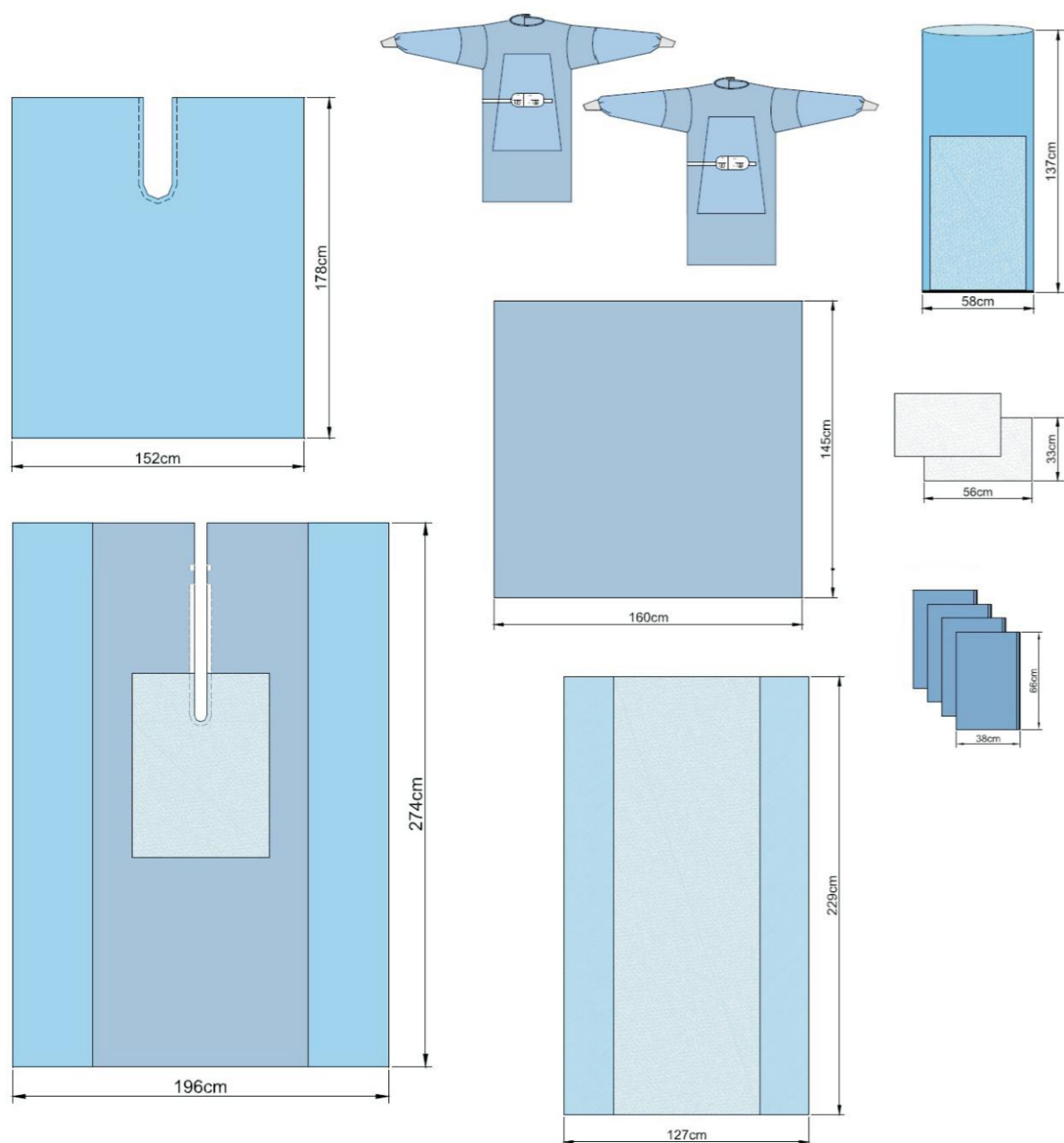

PM1346 Orthopedic Split Pack I

Part No.	Description	Size	Unit	Qty.
PM4034T	Top Drape	240x150cm	Each	1
PM6413	Split Drape	200x300cm	Each	1
PM6515	Drape	150x140cm	Each	1
PM3106	Back Table Cover	150x200cm	Each	1
PM3202	Mayo Stand Cover	76x145cm	Each	1
PM3304	Stockinette	35x122cm	Each	1
PM4042	Tape Strip	10x50cm	Each	1
PM4000	Hand Towel	56x33cm	Each	2

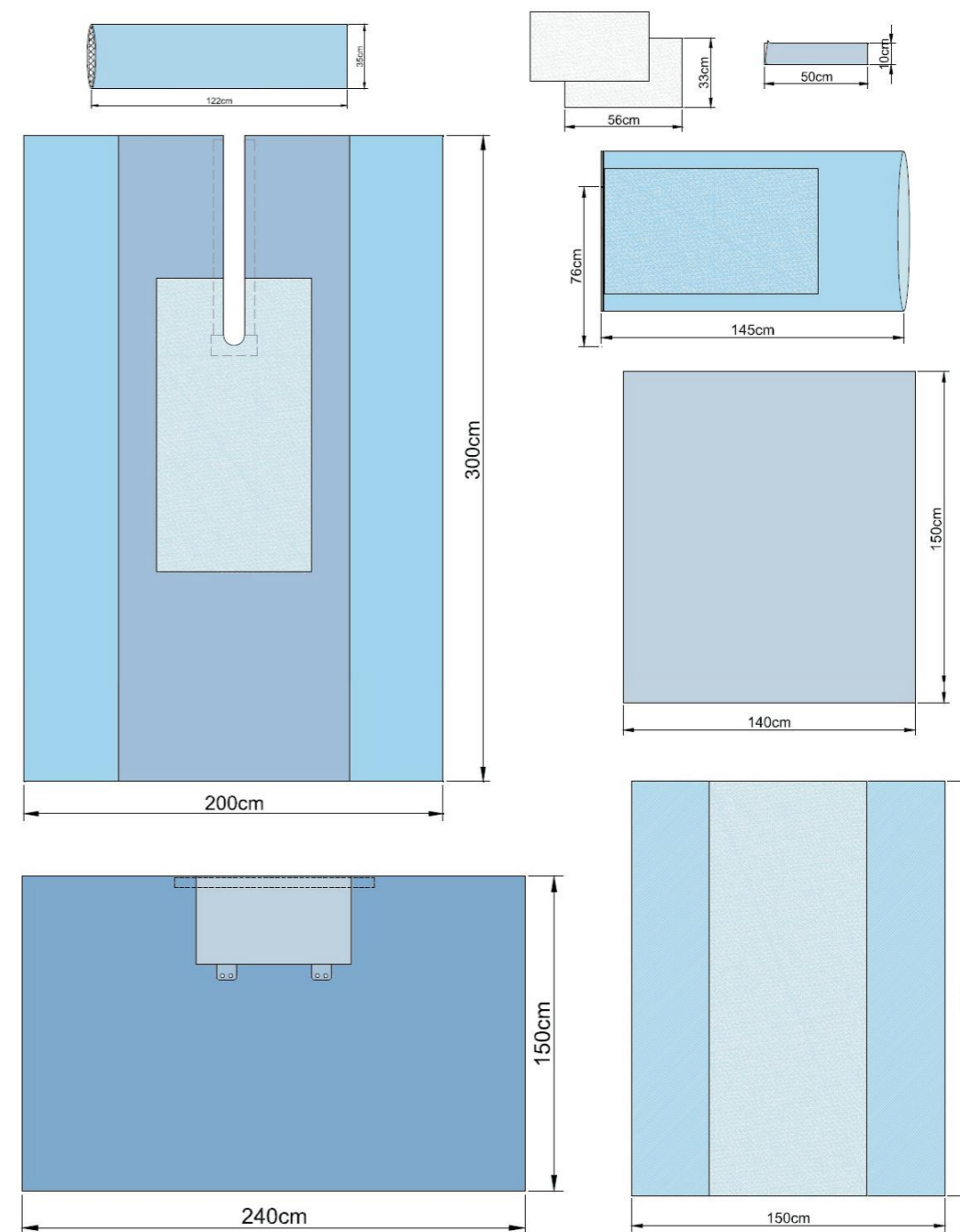

PM1348 Orthopedic Split Pack II

Part No.	Description	Size	Unit	Qty.
PM6105	Top Drape	240x180cm	Each	1
PM6414	Split Drape PE Split 15cm	200x300cm	Each	1
PM6471	Poly U Drape	152X178cm	Each	1
PM3106	Back Table Cover	150x200cm	Each	1
PM3202	Mayo Stand Cover	76x145cm	Each	1
PM3302	Stockinette	30.5x122cm	Each	1
PM4042	Tape Strip	10x50cm	Each	2

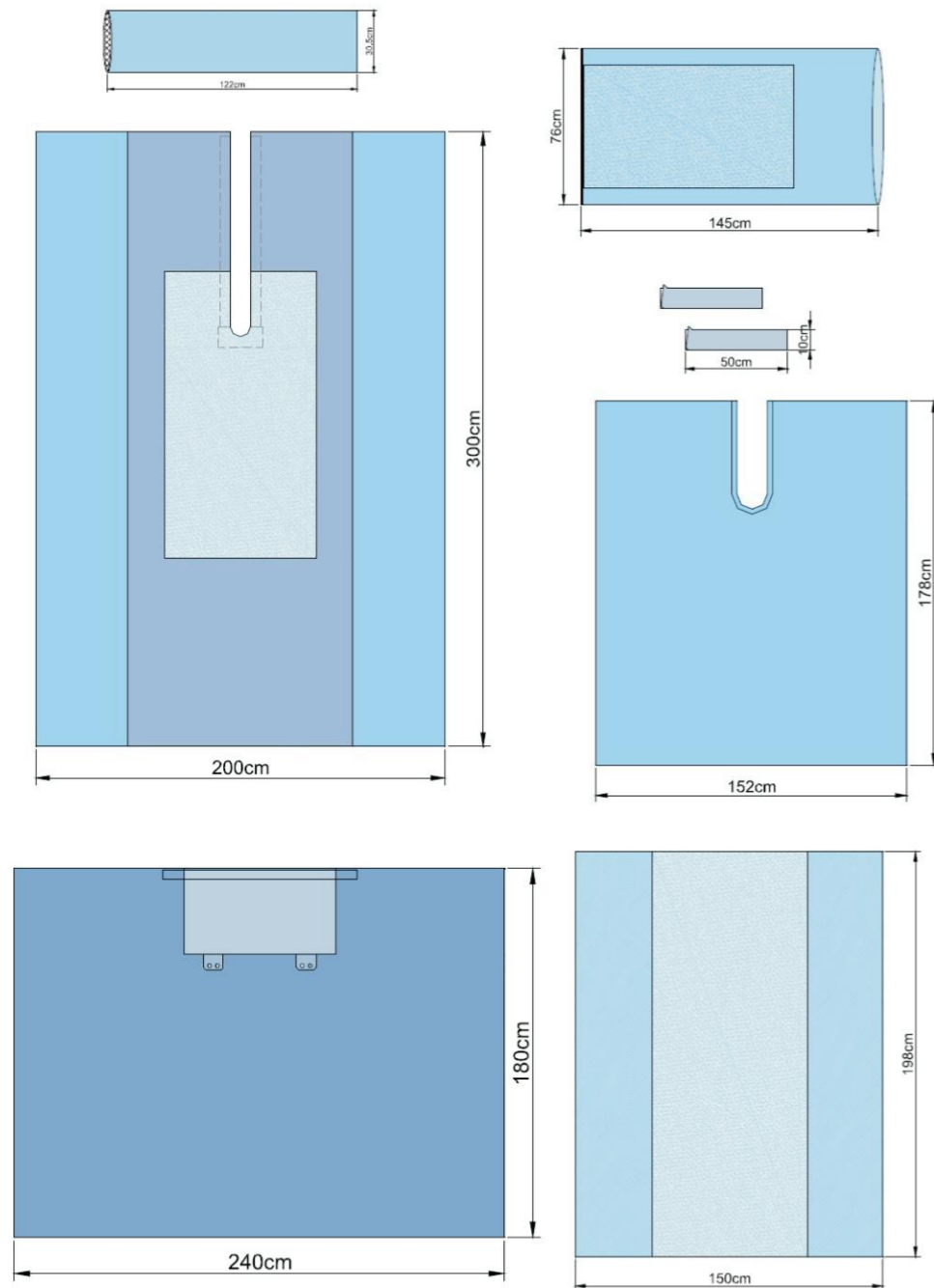

PM1316 General Orthopedic Pack

Part No.	Description	Size	Unit	Qty.
PM3201	Mayo Stand Cover	58x137cm	Each	1
PM4041	Suture Bag	16x28cm	Each	1
PM4000	Hand Towel	56x33cm	Each	2
PM6571	Utility Drape	38x66cm	Each	4
PM5204	Poly Reinf SMS Gown, X-Large	X-Large	Each	2
PM3302	Stockinette	30.5x122cm	Each	1
PM6472	Poly U Drape 60"x84"	152x213cm	Each	1
PM6402	Split Drape	196x251cm	Each	1
PM6103	Top Drape	251x135cm	Each	1
PM3103	Back Table Cover	127x229cm	Each	1

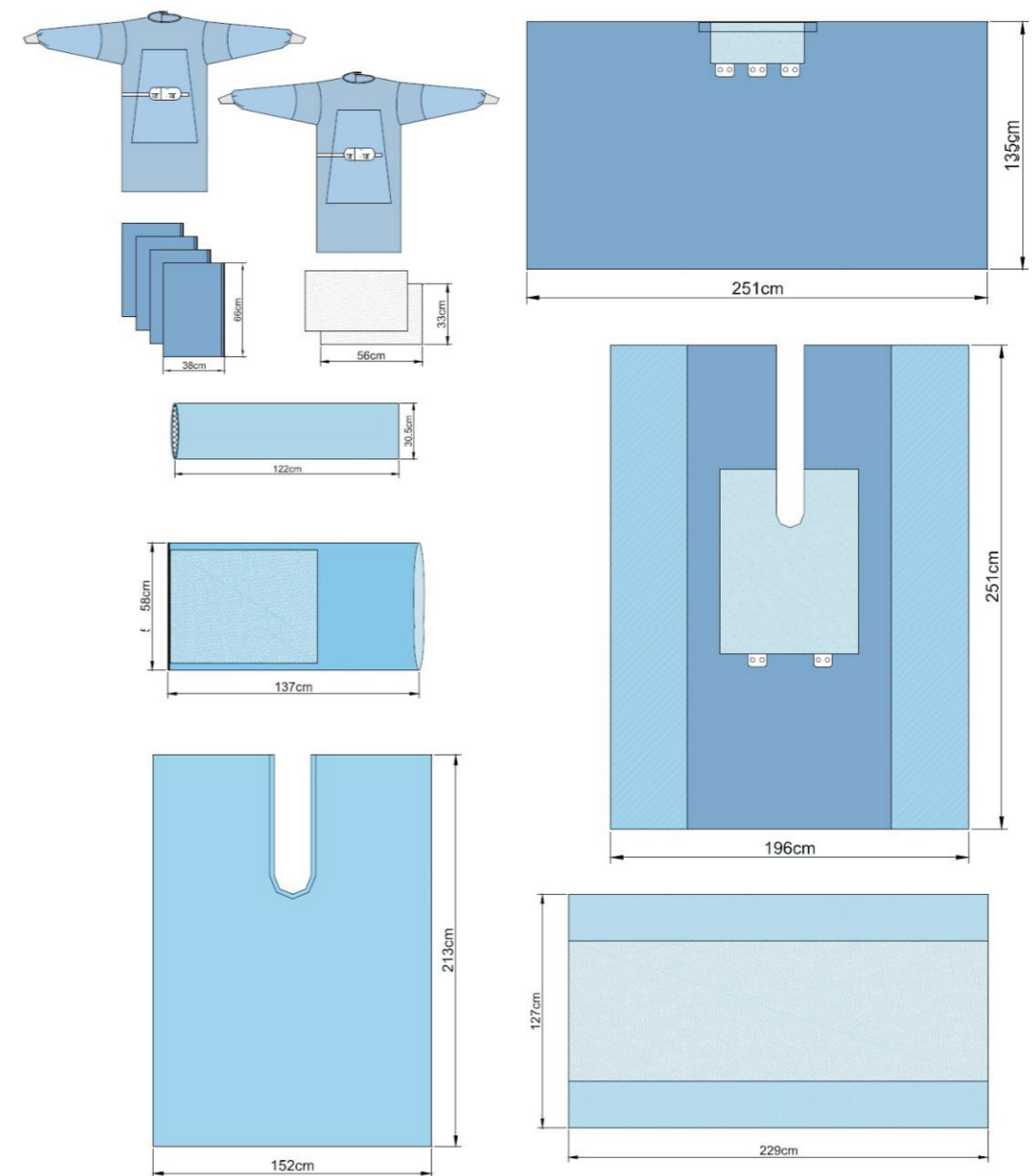

PM1317 Peri-Gyn Pack I

Part No.	Description	Size	Unit	Qty.
PM3402	SMS Leggings	80x120cm	Each	2
PM4041	Suture Bag	16x28cm	Each	1
PM4000	Hand Towel	56x33cm	Each	1
PM6571	Utility Drape	38x66cm	Each	1
PM6902	Under Buttocks Drape	90x128cm	Each	1
PM6503	Drape	140x99cm	Each	1
PM3102	Back Table Cover	112x229cm	Each	1

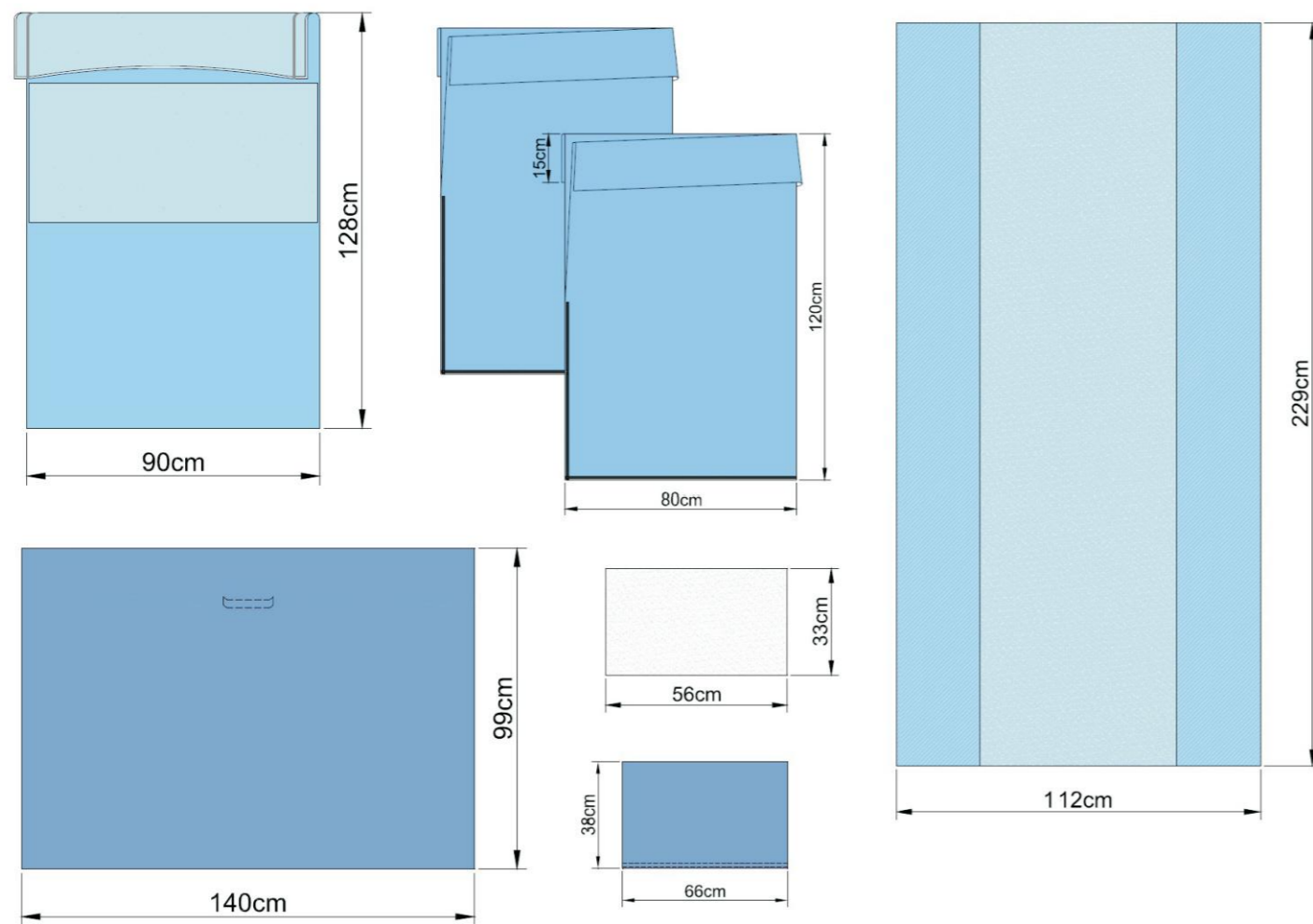

PM1012 Peri-Gyn Pack II

Part No.	Description	Size	Unit	Qty.
PM6902	Under Buttocks Drape	90x128cm	Each	1
PM3402	SMS Leggings	80x120cm	Each	2
PM5101W	Standard SMS Gown with Towel in Wrap	Large	Each	1
PM6571B	Utility Drape	38x66cm	Each	3
PM6503	Drape Sheet	140x99cm	Each	1
PM3102	Back Table Cover	112x229cm	Each	1

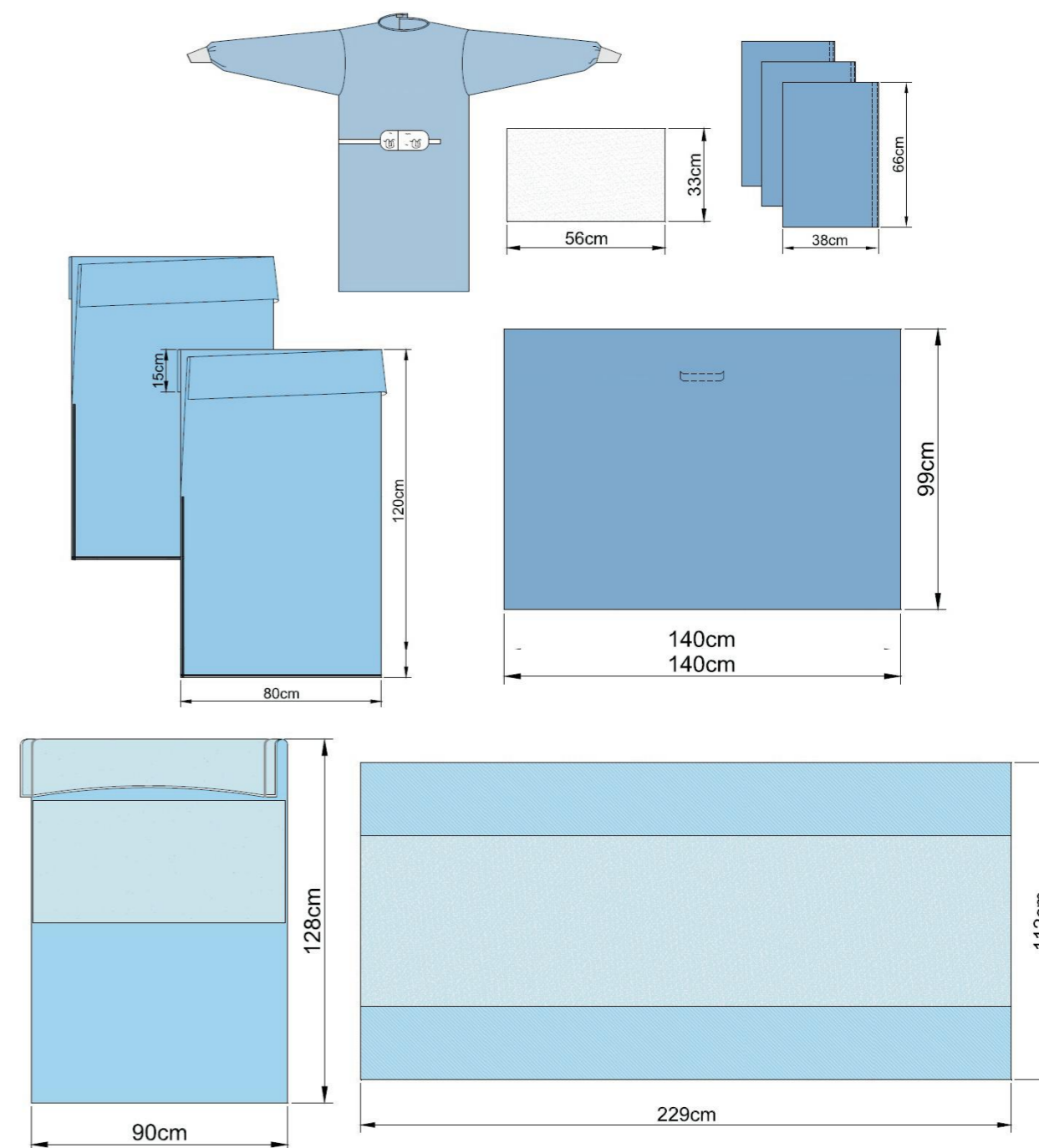

PM1326 Extremity Pack

Part No.	Description	Size	Unit	Qty.
PM3201	Mayo Stand Cover	58x137cm	Each	1
PM4041	Suture Bag	16x28cm	Each	1
PM4000	Hand Towel	56x33cm	Each	2
PM5101	Standard SMS Gown, Large	Large	Each	2
PM6571S	Utility Drape	38x66cm	Each	4
PM6802	Extremity Drape	220x318cm	Each	1
PM3120	Back Table Cover	112x152cm	Each	1
PM3103	Back Table Cover	127x229cm	Each	1

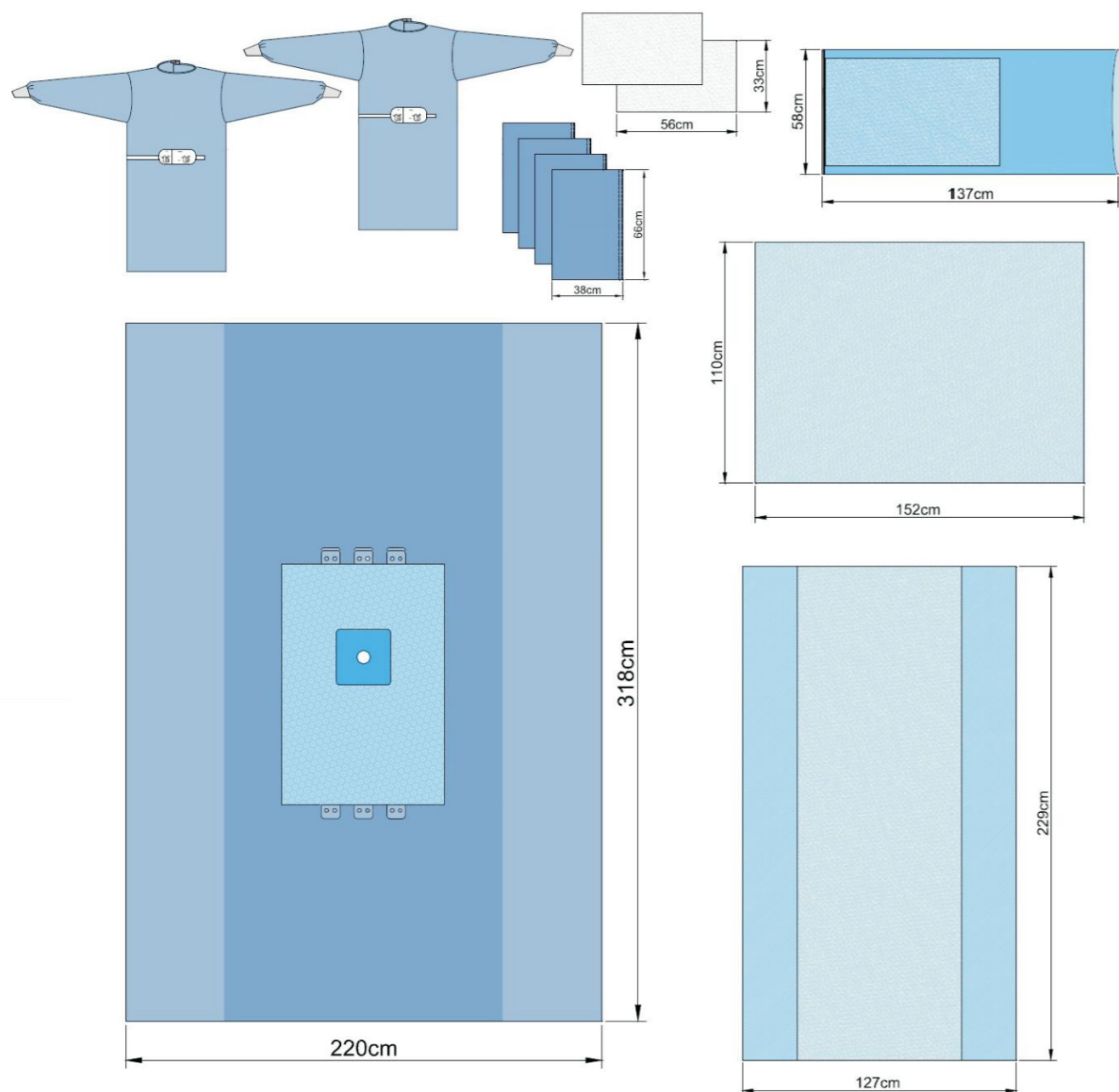

PM1337 Top Extremity(Hand) Pack

Part No.	Description	Size	Unit	Qty.
PM7801	Hand Drape	270x302cm	Each	1
PM6514	Drape	100x100cm	Each	1
PM3106	Back Table Cover	150x200cm	Each	1
PM3202	Mayo Stand Cover	76x145cm	Each	1
PM4042	Tape Strip	10x50cm	Each	1
PM4000	Hand Towel	56x33cm	Each	2

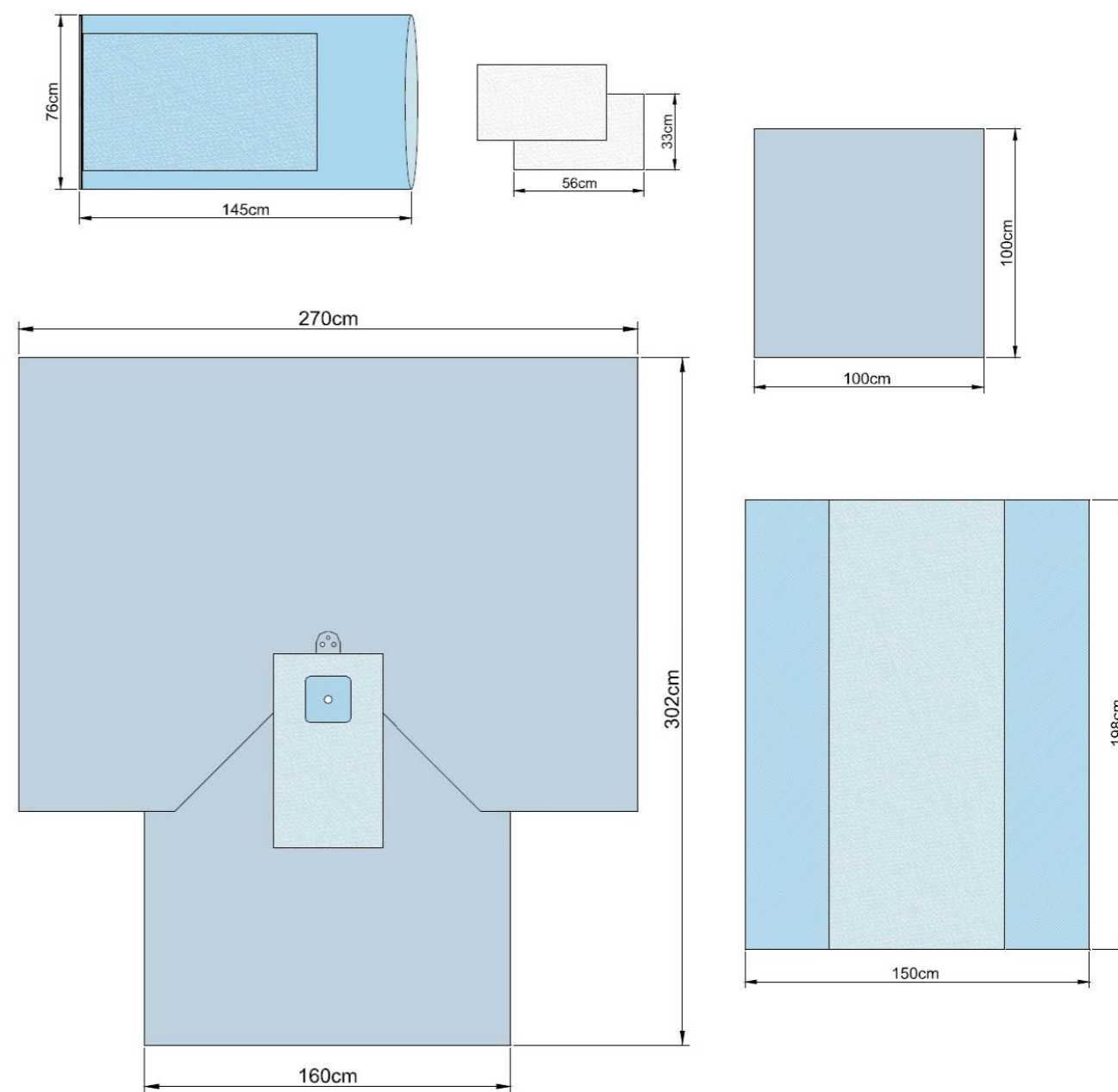

PM1338 Bottom Extremity Pack

Part No.	Description	Size	Unit	Qty.
PM6807	Extremity Drape	220x320cm	Each	1
PM6515	Drape	150x140cm	Each	1
PM3106	Back Table Cover	150x200cm	Each	1
PM3202	Mayo Stand Cover	76x145cm	Each	1
PM4042	Tape Strip	10x50cm	Each	1
PM4000	Hand Towel	56x33cm	Each	2

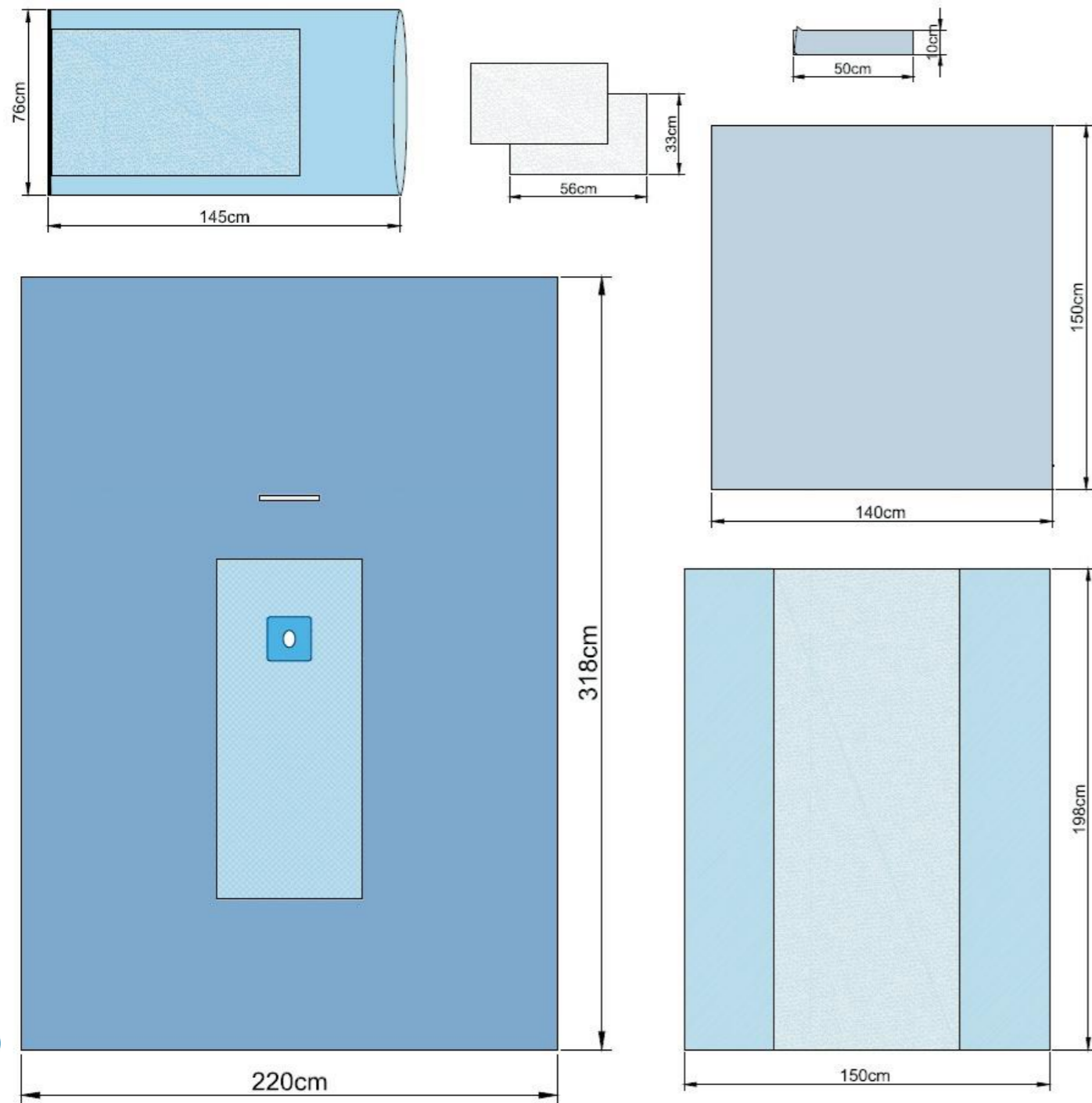

PM1006 General Endoscopy Pack

Part No.	Description	Size	Unit	Qty.
PM3201	Mayo Stand Cover	58x137cm	Each	1
PM4041	Suture Bag	16x28cm	Each	1
PM4000	Hand Towel	56x33cm	Each	2
PM6571	Utility Drape	38x66cm	Each	4
PM5101	Standard SMS Gown, Large	Large	Each	2
PM5101W	Standard SMS Gown with Towel in Wrap, Large	Large	Each	1
808001	X-Ray Sponge		Each	10
PM4008	Endoscopy Drape	270x310cm	Each	1
PM3102	Back Table Cover	112x229cm	Each	1

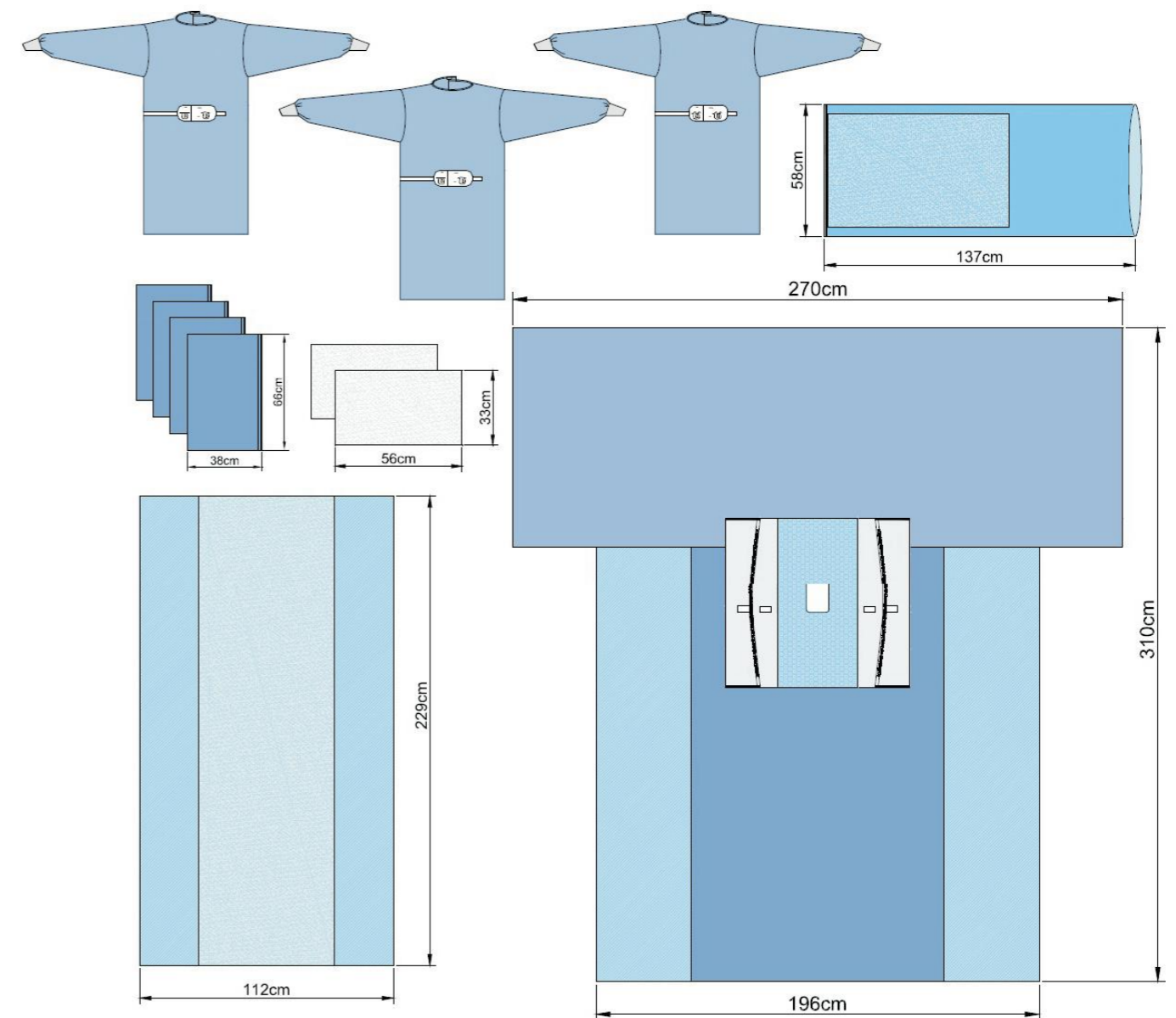

PM1319 Omega Pack

Part No.	Description	Size	Unit	Qty.
PM6303	Omega Drape	170x170cm	Each	2
PM3202	Mayo Stand Cover	76x145cm	Each	1
PM3106	Back Table Cover	150x200cm	Each	1
PM4000	Hand Towel	56x33cm	Each	2

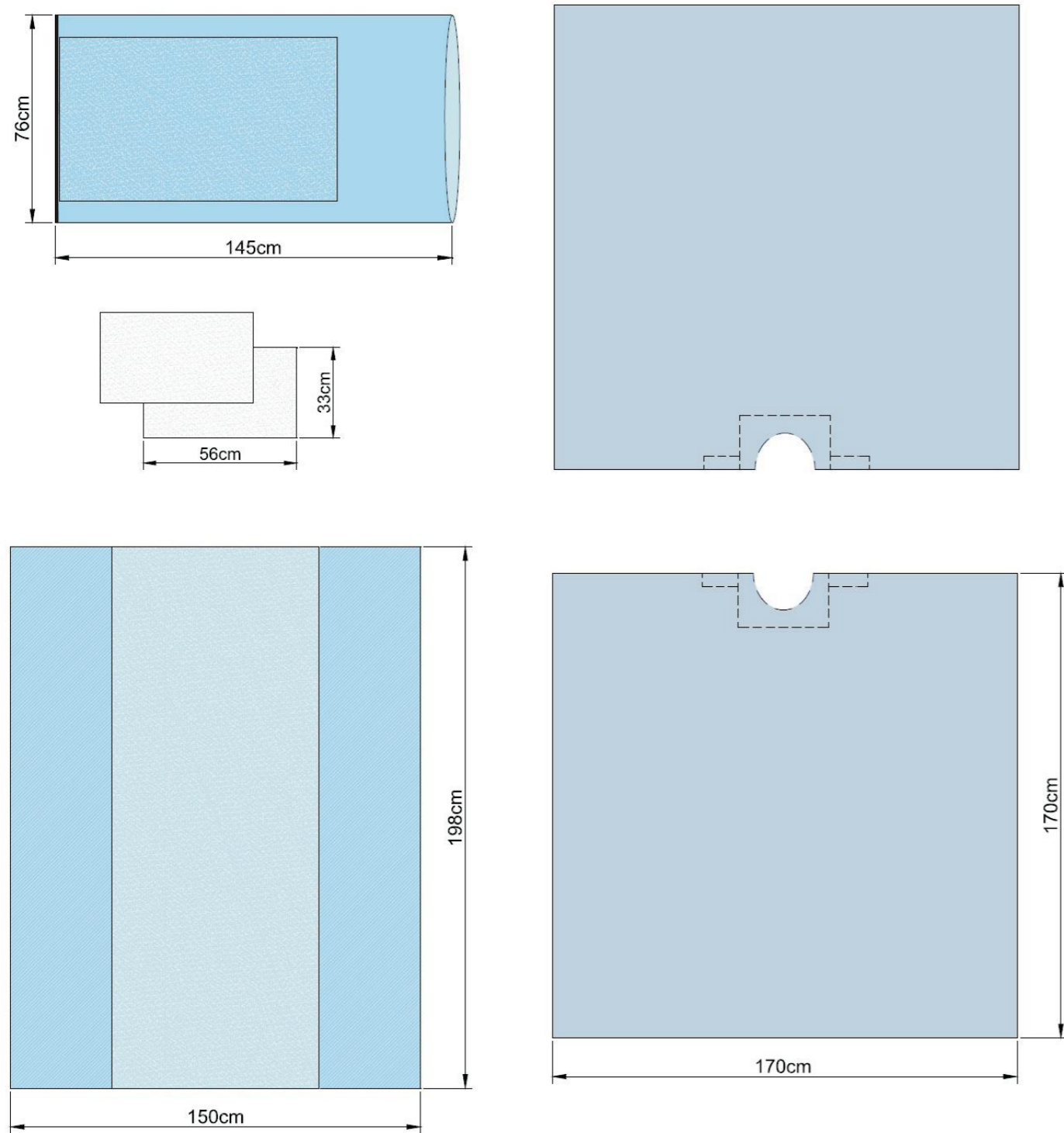

PM1339 Gynaecology Pack I

Part No.	Description	Size	Unit	Qty.
PM6306	Omega Drape	170x100cm	Each	1
PM6905	Under Buttocks Drape	90x120cm	Each	1
PM3402	SMS Leggings	80x120cm	Each	2
PM3106	Back Table Cover	150x200cm	Each	1
PM4000	Hand Towel	56x33cm	Each	2

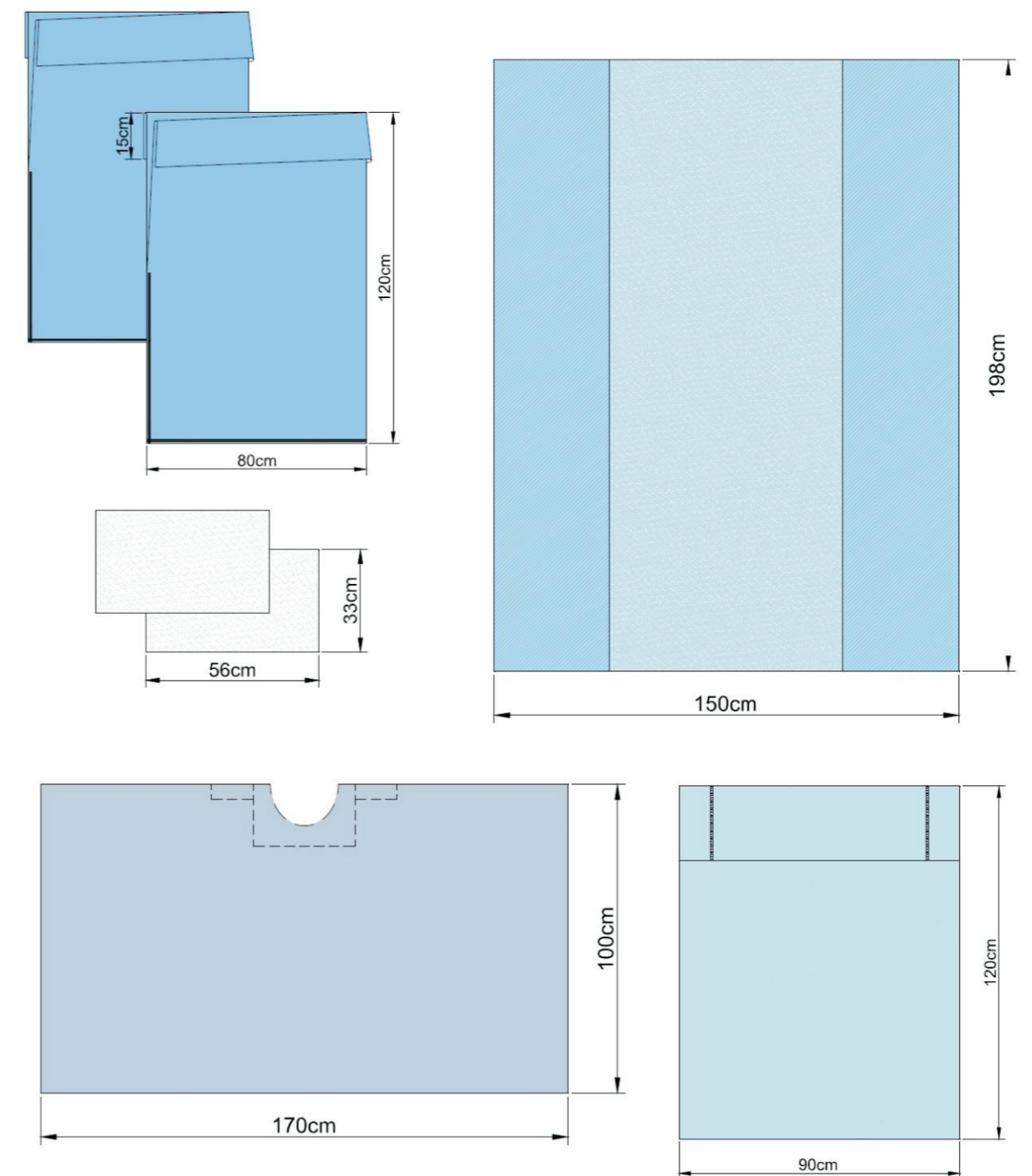

PM1340 Gynaecology Pack II

Part No.	Description	Size	Unit	Qty.
PM4074	Gyn Uro Drape	265x200cm	Each	1
PM6307	Drape with Tape	100x100cm	Each	1
PM3106	Back Table Cover	150x200cm	Each	1
PM3202	Mayo Stand Cover	76x145cm	Each	1
PM4042	Tape Strip	10x50cm	Each	1
PM4000	Hand Towel	56x33cm	Each	2

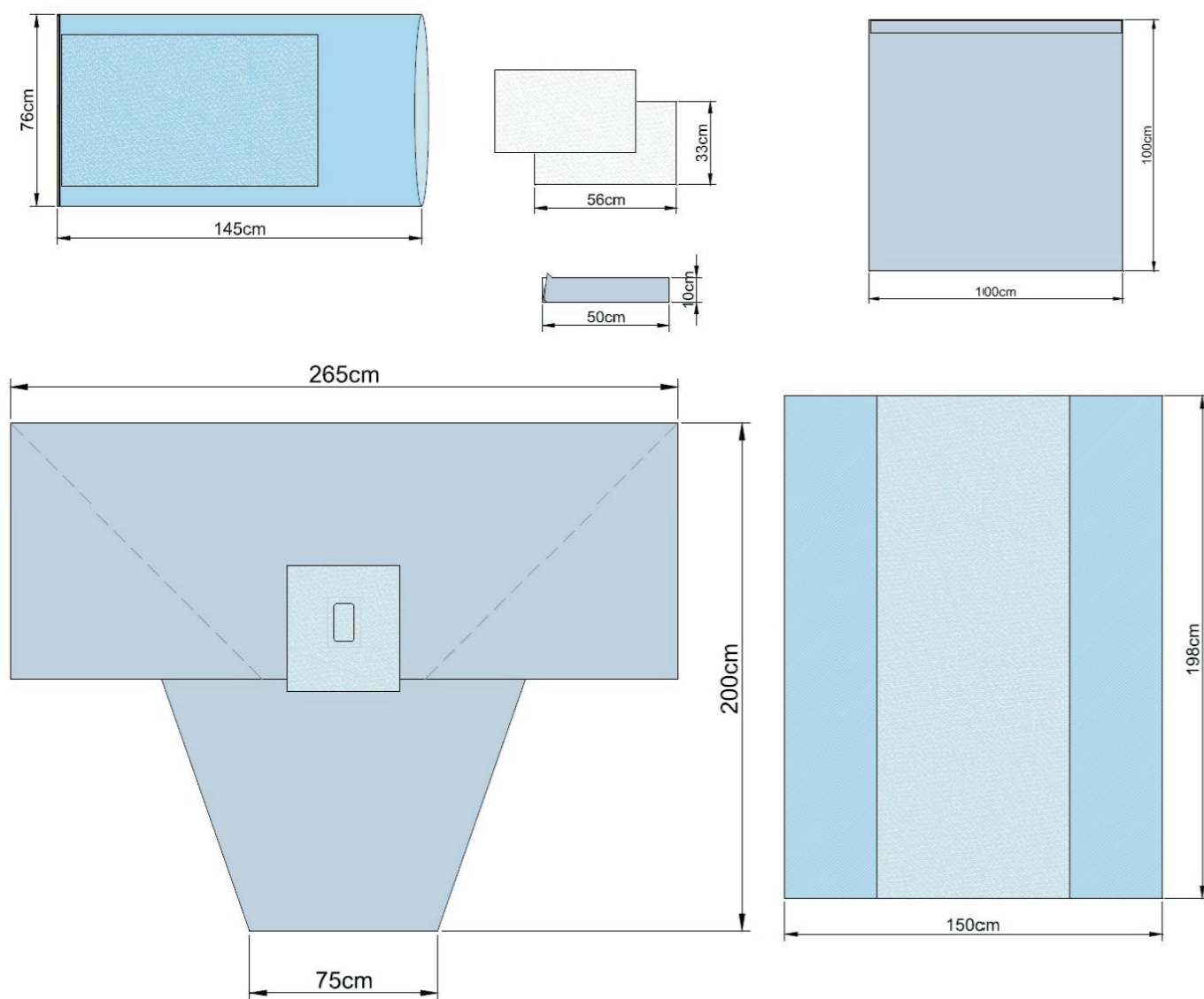

PM1341 C-Section Pack

Part No.	Description	Size	Unit	Qty.
PM7203	C-Section Drape	252x281cm	Each	1
PM3106	Back Table Cover	150x200cm	Each	1
PM3202	Mayo Stand Cover	76x145cm	Each	1
PM6516	BABY TOWEL	80x90cm	Each	1
PM4000	Hand Towel	56x33cm	Each	2

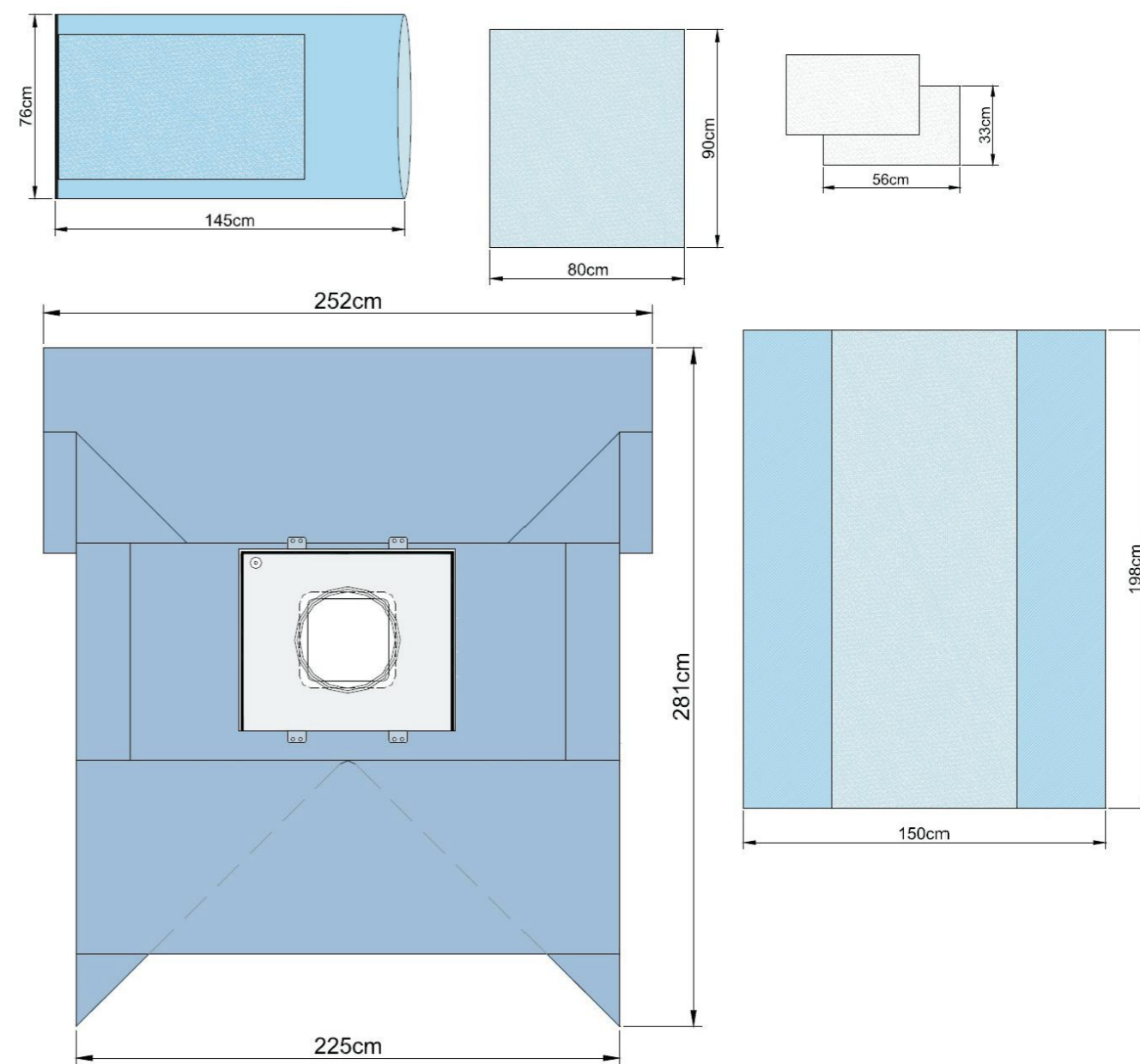

PM1342 Thyroid Pack SMS

Part No.	Description	Size	Unit	Qty.
PM6411	Split Drape Split 50x10cm	240x180cm	Each	1
PM4035T	Bottom Drape	175x175cm	Each	1
PM3106	Back Table Cover	150x200cm	Each	1
PM3202	Mayo Stand Cover	76x145cm	Each <td 1	
PM4042	Tape Strip	10x50cm	Each	1
PM4000	Hand Towel	56x33cm	Each	2

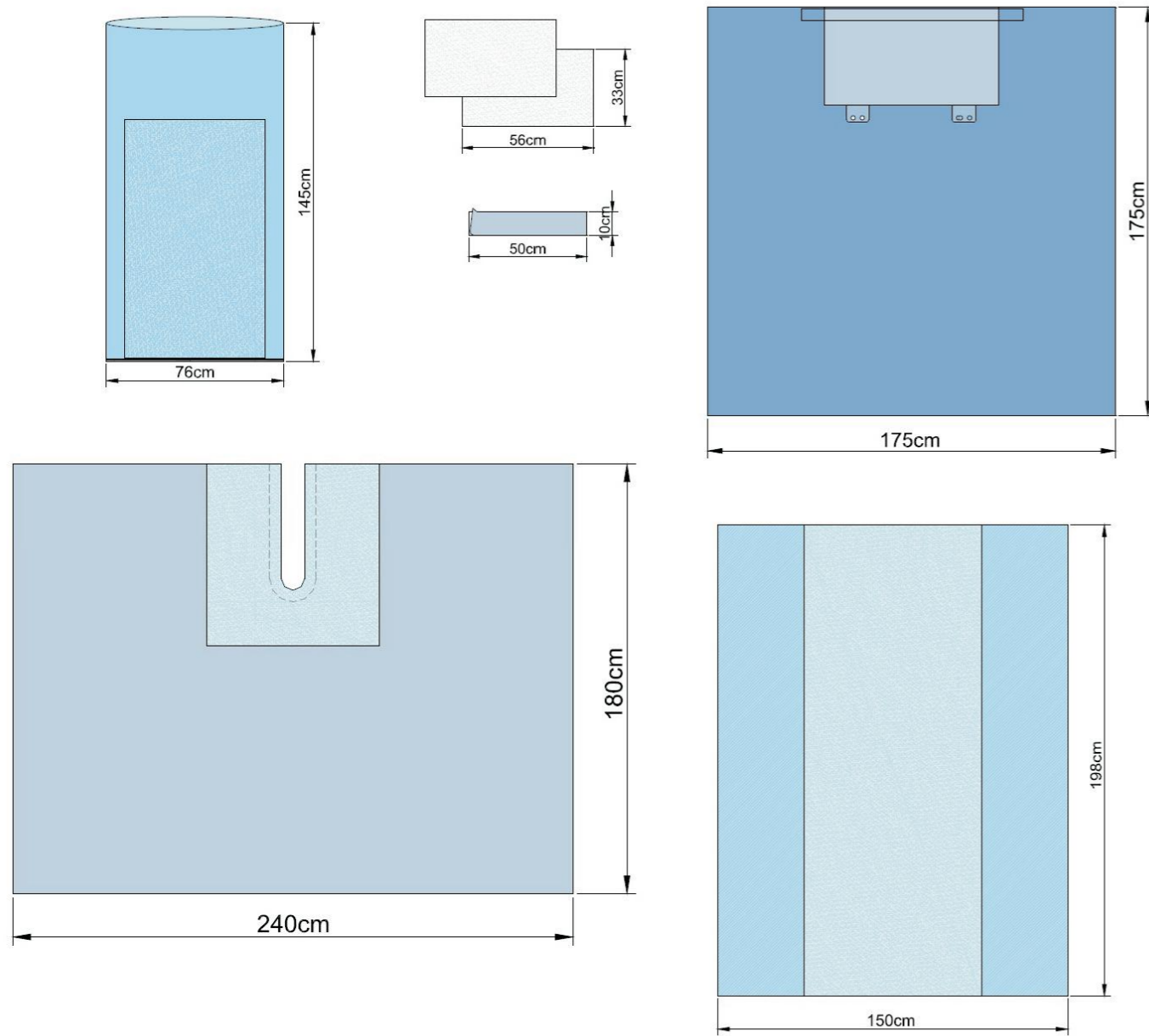

PM1347 Split Drape Pack SMS

Part No.	Description	Size	Unit	Qty.
PM6105	Top Drape	240x180cm	Each	1
PM6413	Split Drape	200x300cm	Each	1
PM3106	Back Table Cover	150x200cm	Each	1
PM3202	Mayo Stand Cover	76x145cm	Each	1
PM4042	Tape Strip	10x50cm	Each	1

