

PD-PIR115 Infrared Sensor Instruction

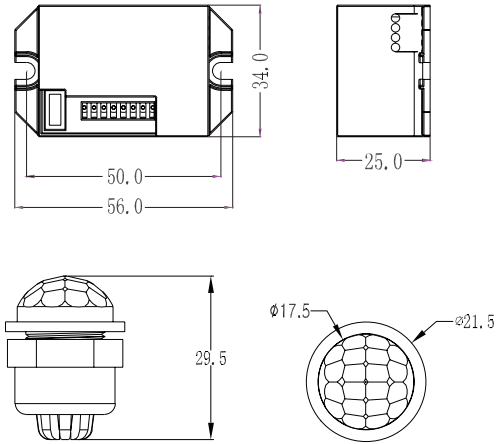
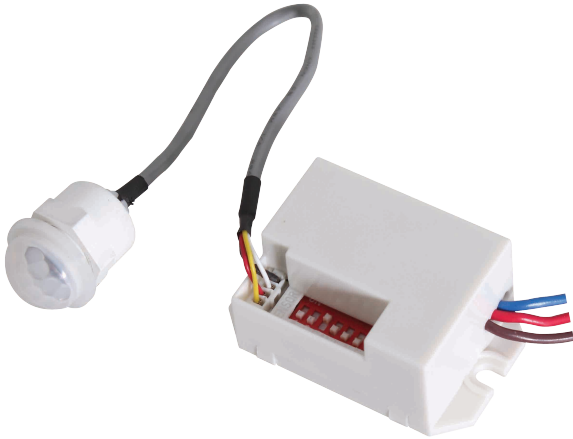

(mm)

Summary

This product is an energy automatic sensor switch, it can identify day and night. It adopts infrared detector, IC and SMD technology, when someone enters its detecting range and triggers it to work, the infrared detector turns on the lamp, after he leaves its range, the lamp will turn off automatically. It can detect the ambient light illumination automatically and set and adjust the value according to the fact need. Such as, the light will turn on and works when the ambient light illumination is under setting value. Once it exceeds the setting value, the light will stop working. It can be installed in indoor, corridor and public-building.

Specifications

Power source: 220-240VAC, 50/60Hz
 100-130VAC, 50/60Hz

Rated load:
 800W Max. tungsten (220-240VAC)
 200W Max. fluorescent & LED (220-240VAC)
 400W Max. tungsten (100-130VAC)
 100W Max. fluorescent & LED (100-130VAC)

Time setting: 5s、30s、1Min、3 Min、5 Min、8 Min
 (adjustable)

Light-control: <10LUX~2000LUX (adjustable)

Detection range: 8m (22°C) (adjustable)

Detection angle: 100°

Working temperature: -10~+40°C

Working humidity: ≤93%RH

Name of each part

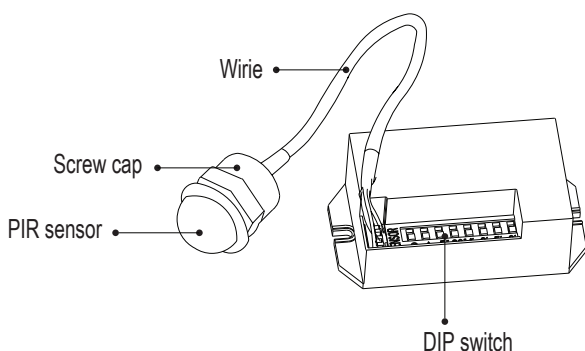

The nuts design at the head of the sensor makes it more convenient to fix on the installation object. There is also wiring for fixing made of plastic at its bottom in order to add its strength when being installed.

Sensor information

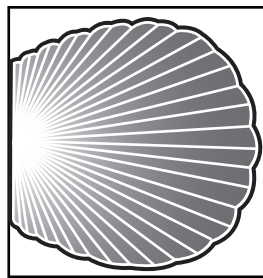
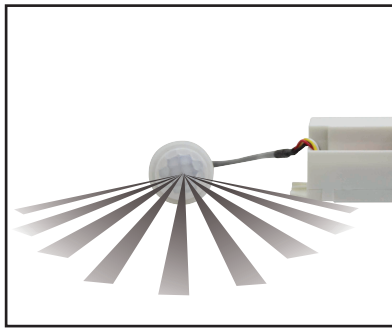

8m (22°C)
Detection range

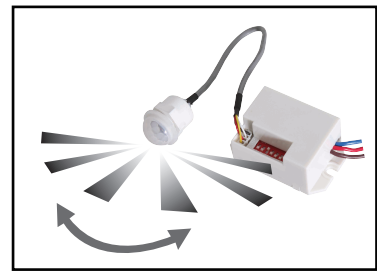

100°
Detection angle

Function

- Adopts 8-bit DIP switch:
 - You can select working light to work only in the light below 10lux or in any light;
 - Adjustable sensitivity;
 - Choose working time-delay of the load: 5s, 30s, 1Min, 3Min, 5Min, 8Min.
- The time that the load work can delay automatically: it re-computes time after the last sensing;
- Out connect infrared detector and sensitization resistor;
- Simple structure and using convenient.

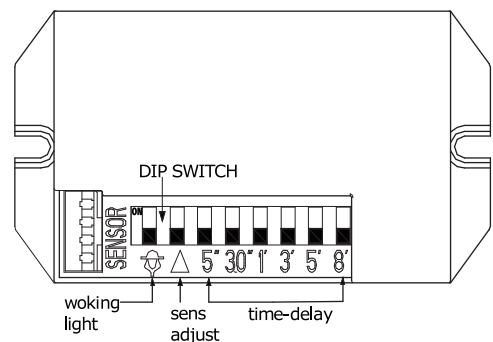

Connection-wire diagram

- Connect brown and blue with power;
- Connect red and blue with load.

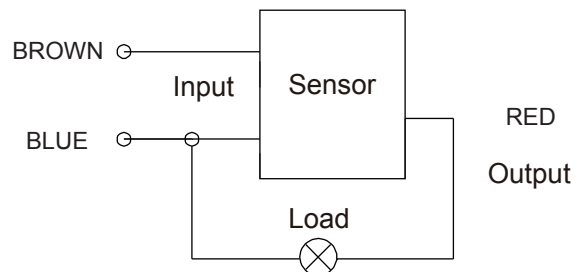

Dip switch setting

- Working light (☀️) selecting:
 - when no slide to ON, it can working in any light degree;
 - when slide to ON, it can only work at night (<10LUX).
- Sensitivity (▽) selecting:
 - when no slide to ON, High sensitivity;
 - when slide to ON, Low sensitivity.
- Time-delay (5", 30", 1', 3', 5', 8')
 - when select a certain time-delay, you only slide it to ON position.

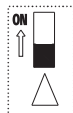
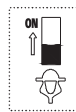

ATTENTION: When use this product, please adjust the sensitivity to an appropriate position you need, please do not adjust the sensitivity to maximum, to avoid the product does not work normally caused by wrong motion. Because the sensitivity is too high easily detect the wrong motion by wind blowing leaves & curtains, small animals, and the wrong motion by interference of power grid & electrical equipment. All those lead the product does not work normally !

When the product does not work normally, please try to lower the sensitivity appropriately, and then test it.

Test

- Slide DIP 5"to ON position and other is on original position;
- Switch on power, after the load turn off, the sensor enter stable working state;
- Sense it once, the load turn on, and after 5s it turn off automatically;
- If slide DIP() to ON position, test it in the daytime, sense it, the load will not be on, cover the sensitization resistor with opaque object, sense it once again, the load will be on, and after 5s it turn off automaticall.

For occasions

It can be installed in indoor, corridor and public-building.

Installed inside on the device with non-metallic materials.

Eg, add the sensor, from one normal lighting to automatic sensor lamp.

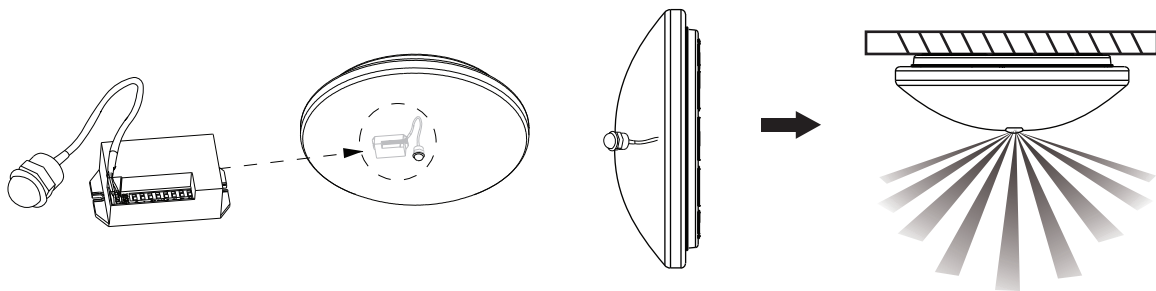

Operating principle of the light-control

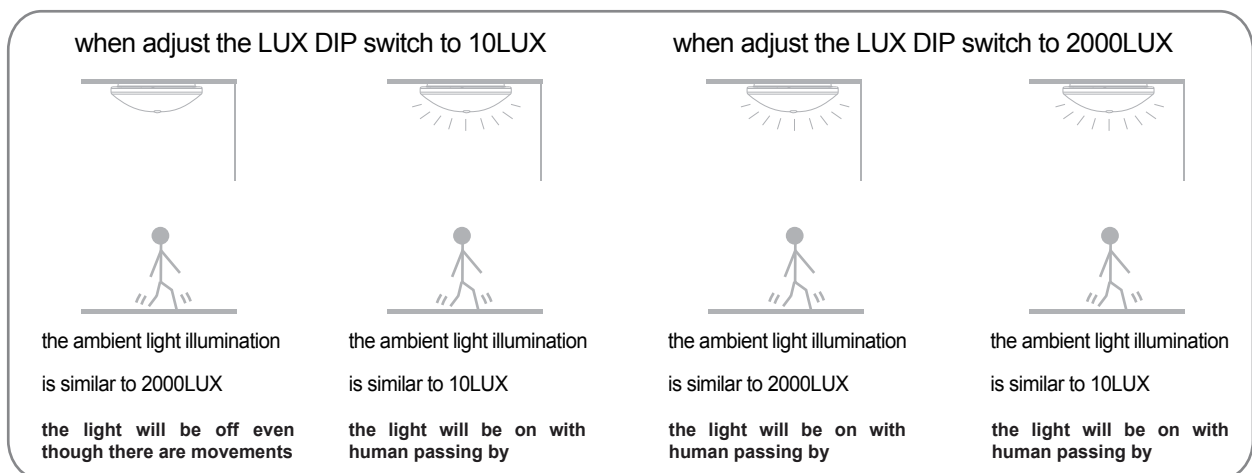

Operating principle of time setting

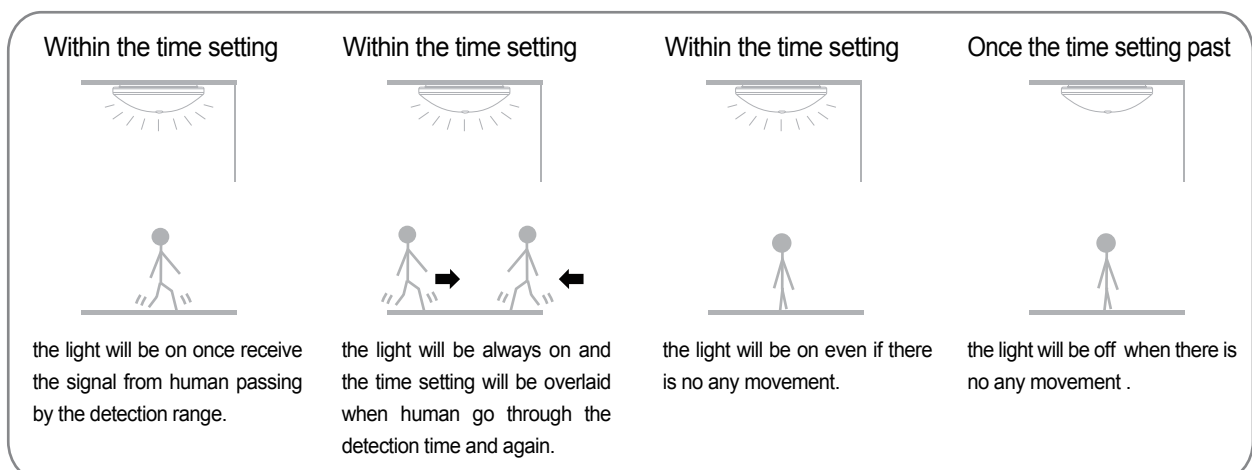

Pay attention to installation

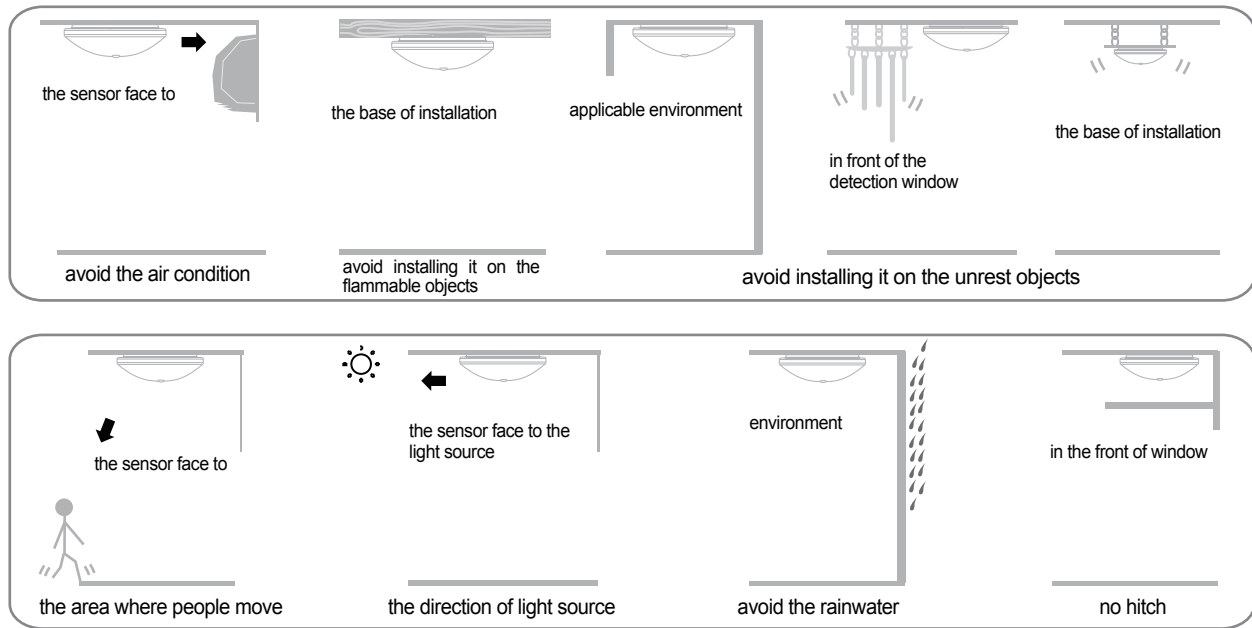

Attention

- The installing personnel should be electrician or with correlation experience;
- Be sure not to install the unit in the place where sun shine, current and temperature change obviously, for example air conditioning, air warm;
- Do not choose the sway object as installing base;
- In front of sense range there should be no obstruction or moving object to influent its detecting.

Remark

1. Keep the sensor face to the area where human usually move.
2. Keep the sensor face to the position of the ambient light in order to get much more exact illuminance setting.
3. If detect the signal again within the time setting, the time setting will be over lied.

Some problem and solved way

1. **The load do not work:**
 - a: Please check if the connection-wiring of power and load is correct;
 - b: Please check if the load is good ;
 - c: Please check if the working light set correspond to light-control.
2. **The sensitivity is poor:**
 - a: Please check if there has hinder in front of the detection window to effect to receive the signal;
 - b: Please check if the ambient temperature is too high;
 - c: Please check if the induction signal source is in the detection fields;
 - d: Please check if the installation height corresponds to the height showed in the instruction;
 - e: Please check if the moving orientation is correct.
3. **The sensor can not shut off the load automatically:**
 - a: Please check if there is continual signal in the detection field;
 - b: Please check if the time setting is the longest;
 - c: Please check if the power correspond to the instruction;
 - d: Please check if the temperature near the sensor change obviously, such as air condition or central heating etc.

Warning!

- When used in different environments, please do not to adjust the sensitivity to the highest. Because that could easily lead to malfunction.
- Please confirm with professional installation.
- Please cut off power supply before installation and removal operations.
- Make sure that you have cut off the power for safety purposes.
- Improper operation caused losses, the manufacturer does not undertake any responsibility.

We are committed to promoting the product quality and reliability, however, all the electronic components have certain probabilities to become ineffective, which will cause some troubles. When designing, we have paid attention to redundant designs and adopted safety quota to avoid any troubles.

This instruction, without our permission, should not be copied for any other purposes.