



## Electric part turn butterfly valve actuator with proportional control unit



Electric part turn butterfly valve actuator with proportional control unit is specially designed for quarter turn operating applications such as ball, butterfly, plug valves and similar usages. Our electric part turn butterfly valve actuator with proportional

control unit can be customized according to the special requirements of customers. AOX is an electric actuator **manufacturer** from China. Based on a wide range of products including high performance multi turn, part turn, and linear actuators, we offer automated solutions for all valve types, ranging from ball valves to dampers.



Zhejiang Aoxiang Auto-Control Technology CO.,Ltd

Tel: [+86-577-59890750](tel:+86-577-59890750)

Phone: [+86-18967766527](tel:+86-18967766527)

Fax: [+86-0577-65921296](tel:+86-0577-65921296)

E-mail: [zjax@zjax.com](mailto:zjax@zjax.com)



## **Electric part turn butterfly valve actuator with proportional control unit Introduction**

Electric part turn butterfly valve actuator with proportional control unit is specially designed for modulating and open-close duty in process technology. Electric part turn butterfly valve actuator with proportional control unit provide the most reliable solution to satisfy our valuable

Zhejiang Aoxiang Auto-Control Technology CO.,Ltd

Tel: [+86-577-59890750](tel:+86-577-59890750)

Phone: [+86-18967766527](tel:+86-18967766527)

Fax: [+86-0577-65921296](tel:+86-0577-65921296)

E-mail: [zjaox@zjaox.com](mailto:zjaox@zjaox.com)



customers and exceed expectations. AOX has its own factory. AOX will continue to develop more advanced products integrating high technology and be ready the most reliable solution.

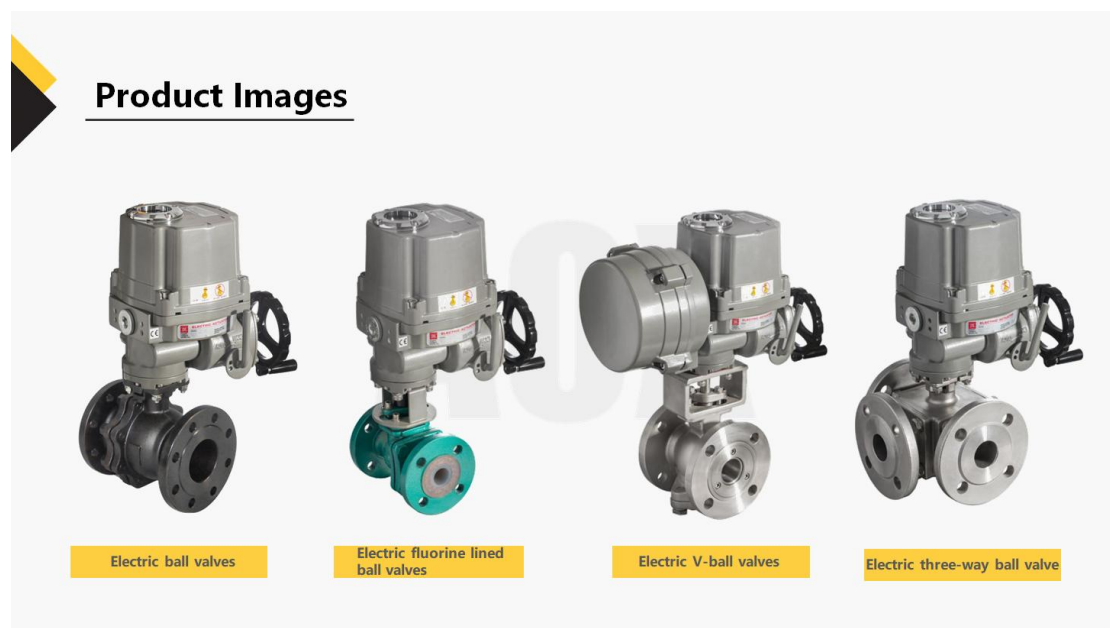
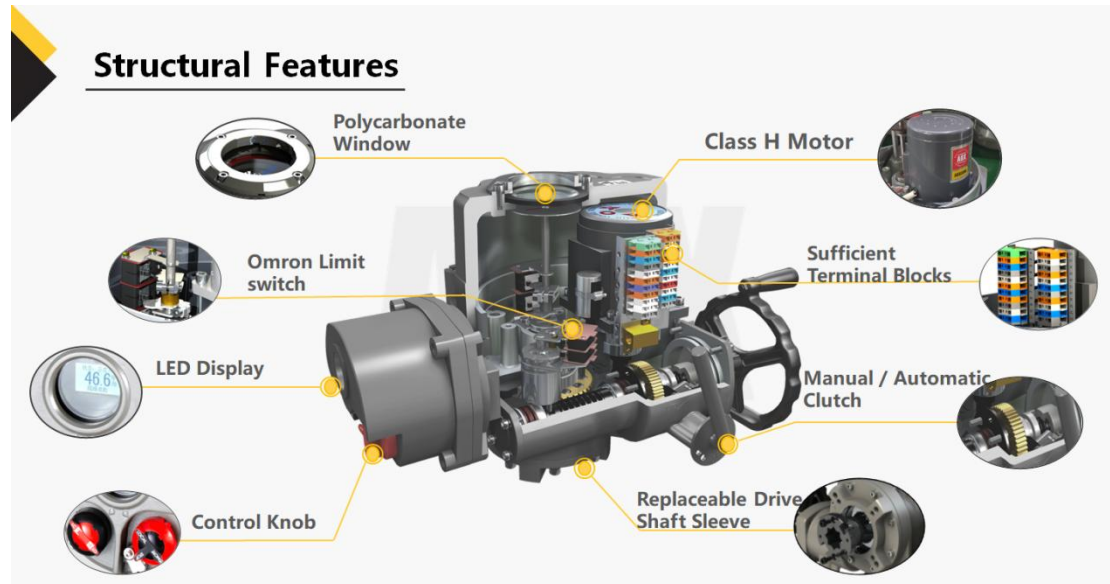

Zhejiang Aoxiang Auto-Control Technology CO.,Ltd

Tel: [+86-577-59890750](tel:+86-577-59890750)

Phone: [+86-18967766527](tel:+86-18967766527)

Fax: [+86-0577-65921296](tel:+86-0577-65921296)

E-mail: [zjaox@zjaox.com](mailto:zjaox@zjaox.com)



## Electric part turn butterfly valve actuator with proportional control unit Parameter (Specification)

Zhejiang Aoxiang Auto-Control Technology CO.,Ltd

Tel: [+86-577-59890750](tel:+86-577-59890750)

Phone: [+86-18967766527](tel:+86-18967766527)

Fax: [+86-0577-65921296](tel:+86-0577-65921296)

E-mail: [zjaox@zjaox.com](mailto:zjaox@zjaox.com)



Model	Max Output Torque	60/50Hz Operating Time	Max Drive Shaft Size	Power	Rated Current (A)				Hand wheel Revolution	Weight
					single phase		three phases			
					110V	220V	380V	440V		
AOX-Q-005	50	18/22	Φ20	20	1.10/0.95	0.55/0.54	0.3/0.3	N/A	10	7.5
AOX-Q-008	80	18/22	Φ20	20	1.10/0.95	0.55/0.54	0.3/0.3	N/A	10	7.5
AOX-Q-010	100	18/22	Φ20	20	1.10/0.95	0.55/0.54	0.3/0.3	N/A	10	7.5
AOX-Q-015	150	21/25	Φ20	40	1.65/1.67	0.88/0.84	0.31/0.31	0.30/0.31	11	17.3
AOX-Q-020	200	21/25	Φ20	40	1.67/1.67	0.89/0.85	0.31/0.31	0.30/0.31	11	17.3
AOX-Q-030	300	26/31	Φ32	90	1.85/1.86	0.92/0.92	0.35/0.35	0.34/0.34	13.5	22
AOX-Q-050	500	26/31	Φ32	120	3.60/3.62	1.55/1.58	0.59/0.59	0.58/0.58	13.5	23
AOX-Q-060	600	26/31	Φ32	120	3.65/3.62	1.60/2.20	0.60/0.59	0.59/0.58	13.5	23
AOX-Q-080	800	31/37	Φ40	180	4.10/4.10	2.15/2.20	0.85/0.85	0.79/0.79	16.5	29
AOX-Q-120	1200	31/37	Φ40	180	4.20/4.10	2.35/2.30	0.87/0.87	0.81/0.81	16.5	29
AOX-Q-150	1500	78/93	Φ40	120	3.65/3.62	1.60/2.20	0.60/0.59	0.59/0.58	40.5	77
AOX-Q-200	2000	93/112	Φ40	180	4.10/4.10	2.15/2.20	0.85/0.85	0.79/0.79	49.5	83
AOX-Q-300	3000	93/112	Φ40	180	4.20/4.10	2.35/2.30	0.87/0.87	0.81/0.81	49.5	83
AOX-Q-400	4000	155/185	Φ40	180	4.20/4.10	2.35/2.30	0.87/0.87	0.81/0.81	82.5	83
AOX-Q-500	5000	155/185	Φ40	180	4.20/4.10	2.35/2.30	0.87/0.87	0.81/0.81	82.5	83
AOX-Q-600	6000	155/185	Φ40	180	4.20/4.10	2.35/2.30	0.87/0.87	0.81/0.81	82.5	83

## Electric part turn butterfly valve actuator with proportional control unit Feature And Application

Torque range: 50~6000N.m

Switching time: 22~185 S

Weight: 7.5 KGS~83 KGS

Applicable valve : Ball Valve (DN15-DN200); Butterfly Valve (DN25-DN400)

Material of Actuator Body: Aluminium Alloy

Related humidity: <90%(25℃).

Local Control Unit: Local control knob of open/close/stop, switch knob of close control remote control/prohibit control(non-intrusive)

Display Mode: LCD, indication of opening(0-100%) and open/close fault

Control Mode: On-off signal control, Modulating (proportional regulation) control, Fieldbus Control etc.

Zhejiang Aoxiang Auto-Control Technology CO.,Ltd

Tel: [+86-577-59890750](tel:+86-577-59890750)









Phone: [+86-18967766527](tel:+86-18967766527)

Fax: [+86-0577-65921296](tel:+86-0577-65921296)

E-mail: [zjaox@zjaox.com](mailto:zjaox@zjaox.com)











## Comparison With Other Products (Eight Major Improvements)

Other manufacturers	Description	Other manufacturers	Description
	The gasket is easily deformed by temperature and other reasons, resulting in reduced sealing performance, which is not very aesthetically pleasing.		The combination of upper and lower cover adopts concave and convex structure, inner gasket O-ring, strong sealing performance, beautiful appearance, high protection level, more convenient for debugging and wiring, only need to open the upper cover
	The use of chemical adhesives may lead to ageing and water ingress due to high temperatures and pressures on site, and the plastic and glazing are easily damaged.		Convex mirror surface, no water accumulation; and continuous valve opening indication, more convenient observation, external metal, not easy to damage
	Ordinary terminal blocks, in the field of temperature difference or vibration, will cause the fastening screws to loosen, resulting in poor contact phenomenon.		The use of self-actuating pop-up terminals guarantees absolute reliability and is a symbol of high-end products.
	The gearboxes are made of plastic, and individual manufacturers use powder alloys for the gears, which are prone to wear.		The gearbox is made of 40Cr, refined by three heat treatments, more solid and reliable

Patent No.: ZL 2013 3 0145624.9  
ZL 2013 3 0145691.0  
ZL 2013 3 0112341.4  
ZL 2013 3 0112302.4



## Comparison With Other Products (Eight Major Improvements)

	Spanner not fixed to the case, easily lost		The spanner is placed on the box, so it is not easily lost on site and is easy to use
	Regulated modules have built-in, electronic components that are affected by the temperature generated during operation.		The adjustment module is mounted externally and the bare board dissipates heat better, solving the contradiction that the maximum temperature of the actuator is 120° C while the temperature of the electronic components of the module is only 85° C. The weak control power supply is used and the quality of the module will not be affected by the unstable voltage on site.
	The screws of other manufacturers' housings are not equipped with an anti-dislodgement function, which can easily lead to the dislodgement of the screws during maintenance when removing the housing at height.		The top cover bolts are specially designed not to come off during maintenance and installation. All external bolts are made of stainless steel and will not rust
	Other manufacturers use M3 screws for unrealistic positioning, inaccurate, slippery threads, M3 spanners are not easy to find on site and other drawbacks.		AOX has improved the electrical cam structure by integrating the four cams into two and isolating them with a butterfly shaped bullet, topped with an anti-loosening nut, and using imported Omron travel switches.

Patent No.: ZL 2013 3 0111005.8  
ZL 2013 3 0111120.5  
ZL 2013 3 0111352.0



## Electric part turn butterfly valve actuator with proportional control unit Details

1. Wide range of voltage available for electric part turn butterfly valve actuator with Zhejiang Aoxiang Auto-Control Technology CO.,Ltd

Tel:+86-577-59890750

Phone:+86-18967766527

Fax:+86-0577-65921296

E-mail:[zjaox@zjaox.com](mailto:zjaox@zjaox.com)





proportional control unit.

2. Motor for electric part turn butterfly valve actuator with proportional control unit: Specially designed induction motor to generate high starting torque and high efficiency equipped with thermal protector to prevent damage from over heating.

3. Manual override:

- Auto / Manual switchable lever and handwheel engagement for emergency manual operation.
- Drive force automatically resorted by motor start, unless lever padlocked to prevent this occurring.

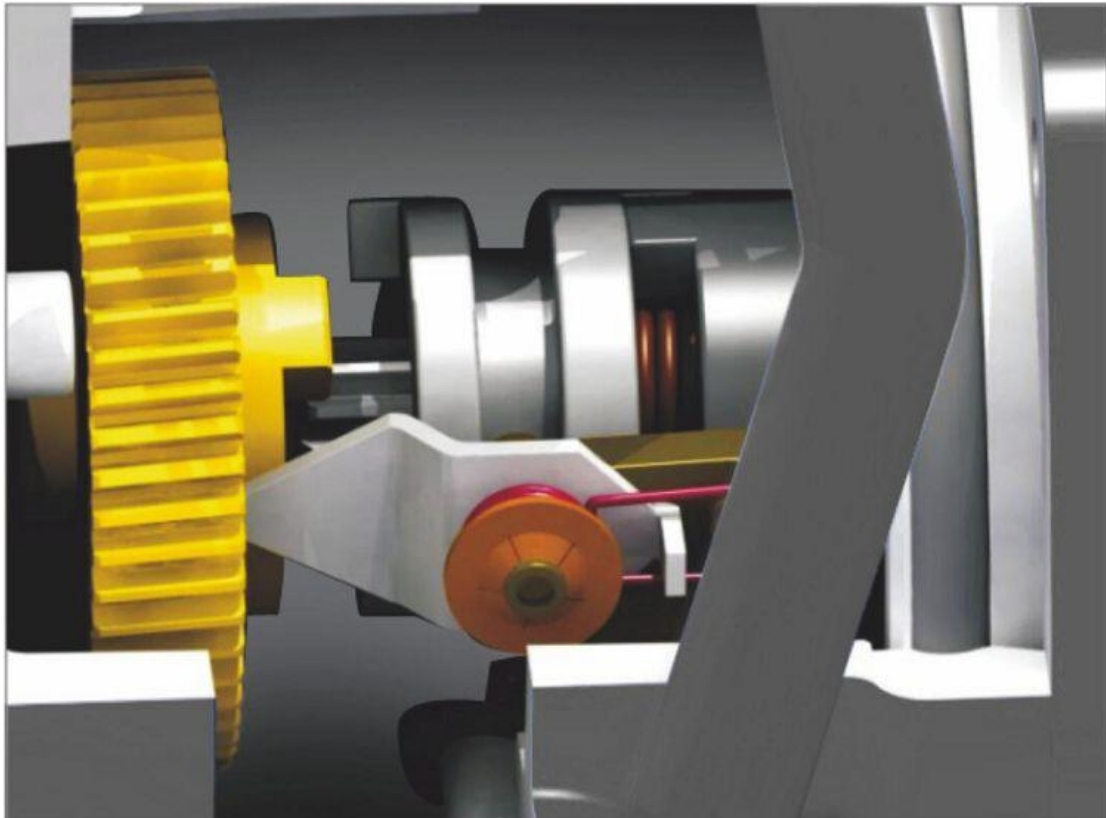

Zhejiang Aoxiang Auto-Control Technology CO.,Ltd

Tel: [+86-577-59890750](tel:+86-577-59890750)

Phone: [+86-18967766527](tel:+86-18967766527)

Fax: [+86-0577-65921296](tel:+86-0577-65921296)

E-mail: [zjax@zjax.com](mailto:zjax@zjax.com)